

RADIO NEWS

REG. U.S. PAT. OFF.

20 Cents
November
1920

Over 100 Illustrations
Edited by H. GERNSBACK

"\$50 FOR THE BEST TITLE
OF THIS PICTURE"
SEE PAGE 276



"THE 100% WIRELESS MAGAZINE"

AUDIOTRON

The Original Tubular Vacuum Detector, Amplifier, Oscillator

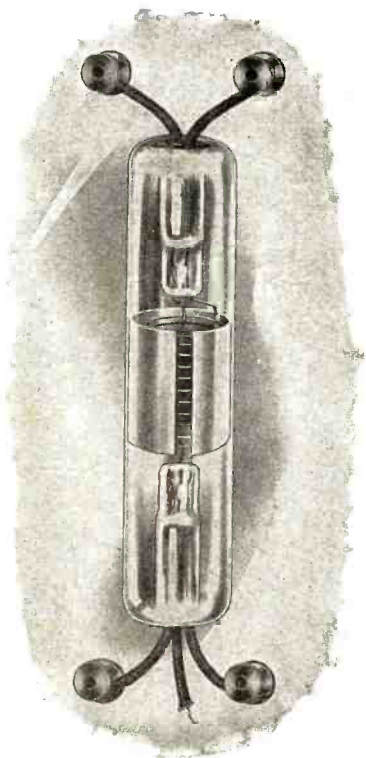

NOW FREE FROM ALL RESTRICTIONS

Dealers and Amateurs:

AUDIOTRONS, recognized as the most sensitive detectors ever produced, are now licensed under Fleming Patent No. 803684 to be used only for amateur and experimental uses in radio communication. They are no longer limited to audio frequency and can now be used as detectors and oscillators as well as amplifiers.

All patent questions also have been definitely settled. Vacuum tube patents are basic and have been sustained by the Federal Courts.

Be sure to get genuine AUDIOTRONS. They outclass any other form of detector and are absolutely free from all legal restrictions or difficulties. These new uses make it even more necessary to insist on the genuine. You can always tell a real AUDIOTRON by the name stamped plainly on the glass.

Insist on the name AUDIOTRON on every tube you purchase. Fully guaranteed by the AUDIOTRON Mfg. Co. (Read the guaranty below).

AUDIOTRON—the only tube satisfactory enough to stand a guarantee!

Your last chance for an AUDIOTRON double filament DETECTOR

Manufacturing reasons make it impossible to continue the present hand-made AUDIOTRON.

This type has a double filament of special thorium tungsten and the operating life is over 2,000 hours. No special socket is required. The electrical and mechanical dimensions result in a heavy plate current and corresponding signal strength. Plate voltage under 40.

The few thousand that will still be produced, however, will be of the same standard of excellence that has characterized every AUDIOTRON.

Already recognized as the most sensitive detector on the market, these few that still remain, with all restrictions on amateur use

lifted, are undoubtedly the greatest opportunity ever offered to amateur radio operators.

See your dealer at once or order direct. Be sure to benefit by this last opportunity to secure a hand-made super-sensitive, double filament AUDIOTRON Detector, Amplifier, Oscillator.

\$6.00 each
(No increase in price)

The AUDIOTRON Exclusive Guaranty: Each and every AUDIOTRON is guaranteed to arrive in good condition and to prove fully satisfactory. Replacement of unsatisfactory tubes will be made free of charge.

AUDIOTRON MFG. COMPANY

(Successors to the AUDIOTRON Sales Co.)

Dept. A. Lick Bldg. San Francisco, California

Dealers—

Get in touch with the AudioTron Mfg. Co. at once. We will give you full information about settlement of all patent difficulties. You will also be interested in our new proposition for wide awake dealers. After the present supply is exhausted, new types of AudioTron manufactured entirely by machinery, will be offered for sale. Our extensive advertising during the Winter will establish definitely the superiority of the AudioTron and will create new sales for you. Be sure to take advantage of our full co-operation at once. Prepare to cash in on the AudioTron reputation, established since 1915. Write us today for full details.

CONNECTICUT RADIO

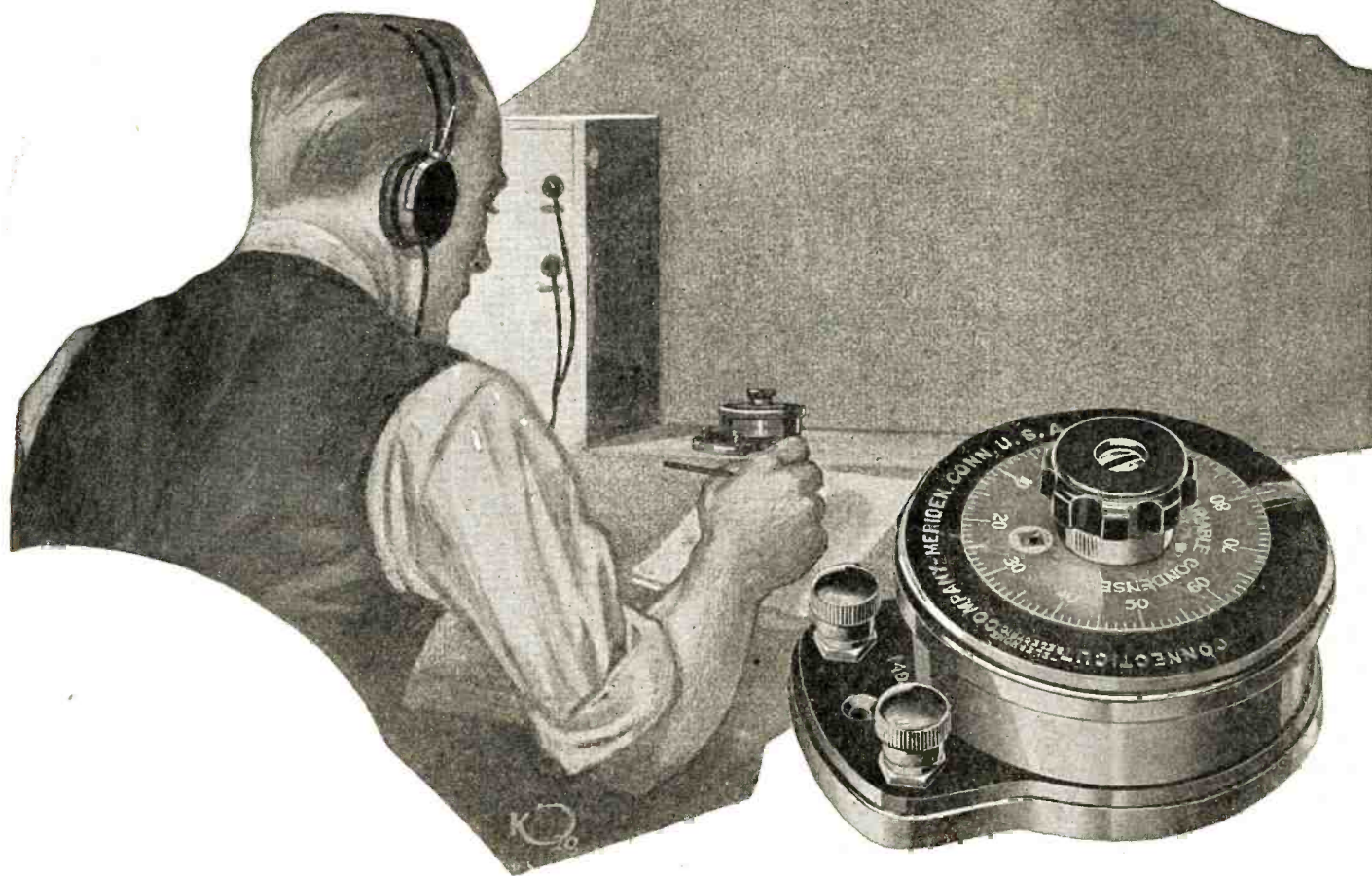
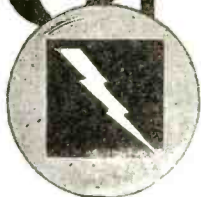

You Can Get Signals From Stations You've Been Missing

"Effective Resistance" has been reduced almost to the vanishing point in the Connecticut Variable Condenser. That means to you a stronger signal—therefore an increased range. You can therefore get signals from stations you've been missing. The scale is graduated over 360 degrees (twice that of the rotary), which means clearer readings throughout, with the special advantage of securing readings at both the low and high extremes of the scale.

These two cardinal advantages enable the average operator to secure results hitherto possible only for the expert.

A simple booklet explains and illustrates this Variable Condenser thoroughly—send a postal for your copy.

CONNECTICUT TELEPHONE & ELECTRIC COMPANY
Meriden Connecticut

RADIO NEWS



CONTENTS

VOL. 2

FOR NOVEMBER

NO. 5

	PAGE		PAGE
"Fool" Ideas, By H. Gernsback	269	Some Unique Radio Appliances.....	284
Enter—The Radio Preacher, By C. A. Stanley	270	A New Continuous Wave Type Trans- mitter	285
The Radio Compass On Board Merchant Vessels, By Arthur H. Lynch	271	The Radio Constructor.....	286
The Invisible Radio Pilot, By Pierre H. Boucheron	272	A VT Transmitter Operating on a Six Volt Storage Battery. By H. M. Pruden	286
Effective 150-20,000 Meter Reception, By D. R. Clemons	273	A VT Audio Frequency Amplifier, By Francis R. Pray	287
Electron Power Tubes and Some of Their Applications—Part II, By William C. White	274	Let's Go! By Charles S. Wolfe	288
Registering Radio Messages on Tape....	276	The Man Who Stands By, By Erald A. Schivo	289
\$50 for the Best Title.....	276	Radio Digest	290
New Amplifying Apparatus.....	277	Club Gossip	291
Electron Tube Transmitter of Com- pletely Modulated Wave, By Louis M. Hull	278	With the Amateurs.....	292
The Audion—Its Action and Some Re- cent Applications—Part 2, By Lee DeForest	280	Junior Section	294
The Kleinschmidt Automatic Transmit- ter, By Lieut. W. Klaus, U.S.N.	283	Dictionary of Radio Terms.....	295
		Junior Constructor	296
		I-Want-To-Know	297
		A New Variable Condenser.....	299
		Correspondence from Readers.....	300

RADIO NEWS is published on the 25th of each month at 233 Fulton Street, New York. There are 12 numbers per year. Subscription price is \$2.00 a year in U. S. and possessions. Canada and foreign countries, \$2.50 a year. U. S. coin as well as U. S. Stamps accepted (no foreign coins or stamps). Single copies, 20 cents each. A sample copy will be sent gratis on request. Checks and money orders should be drawn to order of EXPERIMENTER PUBLISHING CO., INC. If you should change your address notify us promptly, in order that copies be not mis-carried or lost. No copies sent after expiration.

All communications and contributions to this journal should be ad-dressed to: Editor, RADIO NEWS, 233 Fulton Street, New York. Unaccepted contributions cannot be returned unless full postage has been

included. ALL accepted contributions are paid for on publication. A special rate is paid for novel experiments; good photographs accompanying them are highly desirable.

RADIO NEWS, Monthly. Entered as second-class matter June 6th, 1919, at the Post Office at New York, N. Y., under the Act of March 3, 1897. Title registered U. S. Patent Office. Copyright, 1920, by E. P. Co., Inc., New York. The Experimenter Publishing Co., 233 Fulton Street, N. Y., N. Y. The Contents of this magazine are copyrighted and must not be reproduced without giving full credit to the publication.

RADIO NEWS is for sale at all newsstands in the United States and Canada; also at Breatano's, 37 Avenue de l'Opera, Paris. For Great Britain: Geoffrey, Parker & Gregg, 62 & 8A, The Mall, Ealing, London.

Published by EXPERIMENTER PUBLISHING CO., INC.
H. GERNSBACK, President S. GERNSBACK, Treasurer

233 Fulton Street, New York City
R. W. DE MOTT, Secretary

Amplification 100 Times

Do you want to receive signals of marvelous strength; to hold those that gradually fade out and to bring in stations that you have never heard before? You do not need a big aerial to get them—use the new



Licensed Under Armstrong and Marconi Patents

Paragon RA-Ten

Amplifying short
wave receiver

Greatest Improvement in Modern Radio

Do you remember the super service of the old original Paragon RA-6 amplifying short wave receiver? This new set surpasses it in every respect.

and the original RA-6 was the only one of its kind

150% improvement over the old original Paragon, away ahead of all other receivers and excels the most serviceable set on the market today.

Here are the 150% Pointers

A Wave Length range of 160 to 1,000 meters.

24% more sensitive and selective than the RA-6.

All amplification obtained without change of spark tone.

Objectionable effect of change in note entirely eliminated.

Coupling has scale of 180° instead of 90°, giving wider range of coupling.

Controls on all adjustments fitted with vernier attachments permitting of very fine tuning and control.

No dead end losses.

Cabinet of quartered oak; overall size 20 $\frac{5}{8}$ x 8 x 7 $\frac{1}{2}$ "; white filled engraving, bakelite panel, knobs and dials.

Every set sealed before leaving factory, which is a guarantee for two years.

A super product of Adams Morgan Co.'s unapproachable engineers.

And the price \$85.00.

Startling surprises in store for you if you will send for special bulletin describing this set. Remember the old Paragon—this one beats it and all others by miles—our special bulletin tells you how. Send for it—it's free.

Our word of honor to you is our guarantee. Let us prove it.

CONTINENTAL RADIO AND ELECTRIC CORP.

J. D. BLASI, Secretary
DEPT. C. 3

Sole Distributors of the Paragon RA-Ten
6 WARREN STREET

J. STANTLEY, Treasurer
NEW YORK



The Recognized Symbol of Superior Performance

Amrad Knob and Dial

They all say no other Knob and Dial, regardless of price, offers the advantages incorporated in the design at your right. Clockwise rotation. Metal alloy dial shields circuits from capacity effects of the hand. Universal hard rubber knob takes standard 1/4" shaft or 8/32 thread machine screw. Standard Navy practice followed in the entire design.

Type A, 0-180...\$0.80 Type A, 0-180, Dial only, 3"...\$0.40
 Type B, 0- 90... .80 Type B, 9- 90, Dial only, 3"... .35

Send for Descriptive Bulletin R

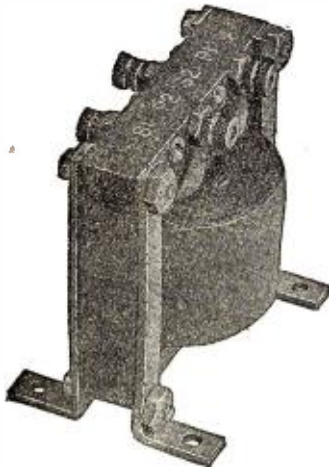

Amrad Ampliformer

A highly efficient type of amplifying transformer adopted after careful development for use in the standard Amrad VT Amplifier Units soon to appear. Noticeable increase of signal strength made possible by use of core laminations punched out of sheet. The low reluctance thus obtained makes the Amrad Ampliformer suitable for use with a wide variety of vacuum tubes.

Type A-1, as illustrated.....\$7.00
 Type A, unmounted 5.00

Send for Descriptive Bulletin S

Amrad Cabinet and Panel

Here's one of the popular sized Amrad Standard Cabinets—10x5x6 1/4 inches, Type B. This is one of the new line of Amrad Standard Parts which have met with such favorable approval with operators everywhere—particularly those who build their own equipment. A small complete Receiver, a Two Stage Amplifier, a Detector-One Stage Amplifier or small Transformer units for CW may be easily mounted within it.

Type A—Cabinet with Panel, 5x5x6 1/4.....\$3.00
 " B—Cabinet with Panel, 10x5x6 1/4, as illustrated 5.00
 " C—Cabinet with Panel, 10x10x10.....10.75

(Any combination of above types available. Either cabinets or panels may be obtained separately.)

Send for Descriptive Bulletin R.

Radio Operators: Amrad Bulletins are sent free upon request. The complete Amrad Catalog sent free, and your name put on our mailing list upon receipt of your dealer's name and address. Visit your nearest Amrad dealer, as advertised in August Radio News, and inspect the latest Amrad products.



AMERICAN RADIO AND RESEARCH CORPORATION

15 Park Row
 New York

Address all Communications
 to New York Office

Factory and Laboratory
 Medford Hillside, Mass.



RADIO NEWS

H. GERNSBACK — EDITOR
PIERRE H. BOUCHERON — ASSOCIATE EDITOR

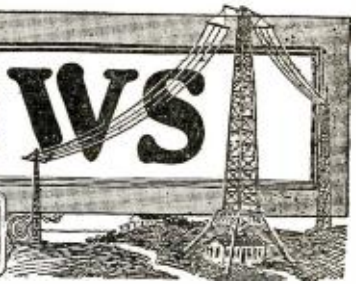

Vol 2

NOVEMBER, 1920

No. 5

Fool Ideas

ONCE upon a time there lived a young fool whose first name was Guglielmo. Like all fools he was of an inquisitive nature. When he was quite young his professors of physics had assured him that the air was one of the best insulators imaginable. Of ether they knew and thought little. Nevertheless, this young fool, whose second name by the way was Marconi, seriously questioned these teachings. So he started to experiment with spark coils and cōherers and other fool paraphernalia, and by and by he found that though his professor had been right and the air really was an insulator, he could in spite of this send messages across space. A little later this same young "fool" thought that he might send messages from Ireland to America, in spite of the fact that a wall of water, due to the curvature of the earth, intervened to several hundred miles in height.

He knew quite well that the electro-magnetic waves could not travel through this water wall, but nevertheless, he had a notion that he might send messages across it, although all the wisecracs of that day laughed and scoffed at his preposterous dreams. You know the result. Messages now fly across the sea every hour of the day, and while the waves may not go through the water, they certainly curve around it, and most of our scientists today are still not quite certain as to how it is all done.

Then there was another young "fool," whose first name was Tommy. Tommy had been assured by all the experts of the day that a vacuum was one of the best non-conductors of electricity. This, however, failed to impress him. So one day Tommy, whose second name by the way was Edison, took an electric bulb and inserted two filaments in it instead of the usual single filament. Quite foolishly he tried to find out if electricity would now pass across the vacuum intervening between the two hot filaments. Contrary to all physics books, it did just that—and our audion today is the result. We could go on *ad infinitum* quoting similar "fools" who made history, but this is not the object of this editorial.

People like to walk the beaten track because it is easier. Only the exceptional person leaves the road and tries to forgo ahead into the unknown. As a rule that person strikes it rich. Perhaps our readers would not mind reading another recent "fool" idea described by Mr. Robert Selden Rose, of Marquette, Mich., on page 298 of this issue. What Mr. Rose does is of course contrary to every good sense, and according to Hoyle should never

work. Strange to say, however, it does, and so it goes.

Which brings us to another "fool" idea of the day. We are now deeply immersed in what we may technically call the vacuum tube "wave." Everything is vacuum tubes. It is the rage of the day. Talk to anyone about detectors, and he would immediately picture a vacuum tube. Nothing else has any room in our imagination today. To be sure, the vacuum tube has done wonderful things and continues to do wonderful things, and far be it from us to belittle its wonderful achievements. But that should not deter us from looking ahead, and asking ourselves: Is there really nothing better than the vacuum tube for detecting electromagnetic waves? There is nothing of that sort, to be sure, today, but what will tomorrow bring? No one doubts for a moment that more sensitive and better detectors will some day be evolved.

Of course, considering the vacuum tube alone it is not so very wonderful if used as a detector. As anyone who has done a lot of radio work knows, a really sensitive piece of galena or radiocite will detect almost as well and in many cases better than the audion, but of course the crystal detector is utterly insensitive when compared with a two or three-stage amplifier.

Now for the fool idea. Is it impossible to take a crystal detector and make an amplifier of it? Is it not possible to devise some means whereby the sensitiveness of the crystal detector can be amplified similarly as the vacuum tube detector is amplified? This is, of course, only an idea, and the writer does not know how it can be brought about, but it certainly should be possible. Has anyone ever tried a good crystal detector in a high vacuum under all experimental conditions? Has a crystal detector been tried in various gases? Has a crystal detector been subjected to high compressed-air experiments? These are only a few thoughts—worth perhaps nothing—worth perhaps a lot if they lead to other thoughts. Then again, we might take a crystal detector and place it into some kind of a magnetic field in order to get results. Has anyone ever tried this? Some years ago, the writer constructed an audion which instead of the usual plate had a piece of pure silicon. He thereby obtained a double action, viz., a crystal detector as well as audion combined and the device worked well.

These are only ideas, fool ideas perhaps, but worth looking into. Who will be the first to make a crystal detector an amplifier? He would earn the ever-lasting gratitude of the radio fraternity.

H. GERNSBACK.

Enter—The Radio Preacher

How a Preacher in Wichita, Kansas, Broadcasts Sermons via Radio

By C. A. STANLEY*



Dr. C. B. Wells, the Original Radio Preacher.

YE olden time circuit preacher in Kansas who rode from parish to parish, little dreamed that twenty years hence his more modern followers would step to the radio transmitter, close the switch and for twenty minutes preach to a greater number of listeners than his complete circuit preaching ever reached. Even the average layman, quite well read in scientific subjects, does not always realize the wonderful strides made in radio telephone and telegraph research work.

THE FIRST AND ORIGINAL "SKY" PILOT

From my private station in Wichita, Kansas, there is transmitted every evening, at a specified hour, such radio news and data as may be of interest to the local amateur and experimenter. On a certain Sunday evening in May, as I sat in my station ready to send out my evening "Q S T," Dr. C. B. Wells, who by the way, is teacher of Bible at Fairmount College as well as pastor of the Fairmount Congregational Church, chanced to pass, dropt into the station, took me to task for not having attended morning service, and then and there suggested that the use of the radio station on the Lord's day should henceforth be devoted to the Lord's work. I immediately took down Dr. Wells' sermon and transmitted it to the hundreds of stations within hearing; and it has now become an established practice to send out these sermons every Sunday evening at 7:30. Letters of appreciation addressed to the "Radio Preacher" and the "Wireless Parson" have been received from all parts of the middle west.

A jeweler located in a small town in northern Kansas, where little ever occurs to disturb the country folk, goes to his store every Sunday evening, copies the sermon on his jeweler's receiving set and posts it on a bulletin board in front of his store where a goodly number of non-church-going people gather to read the Doctor's sermon.

*President Cosradio Co.

THE "BUG" CAUSES SEPARATION OF MAN AND WIFE

On July the 18th this year, Dr. Wells' sermon was sent out as usual, a portion of which follows:

"The subject for tonight is "Love One Another." This sounds rather mushy to some people, but in these three words is found the secret of success for the nation, the firm and the individual. Without love life is a failure. Did you ever stop to think that love is simply a desire to help the other fellow play the game fair and look the world square in the face with a feeling of pity for the man who is crooked?"

Shortly afterwards I received the following letter from southern Texas:

Radio Preacher, 9BW,

Wichita, Kansas.

Dear Sirs Was listening in tonight and working a number of hams, when I heard for the first time your "Q S T." I tuned the old receiver in until you were very QSA and copied your sermon. Say O. M. that's the first sermon I have listened to for ten years. Am station agent here for the ——— Railroad, and four years ago I acquired the wireless bug. Put up an aerial and constructed a receiver. Sure enough, I soon got the fever in real shape, sat up nights until long after midnight. For awhile everything went O. K. but after a while the late hours became an old story to friend wife, and she accused me of neglecting her and the baby. Well, maybe I did, so I laid off for awhile; but alas, I couldn't keep away from the old set. Well O. M. the story's a long one, and to cut it short, wife and baby left me. They now live with her mother over the other side of town. I see them about every week. Yes, I guess I love them, but I sure love to hear the old "sigs" come in. I am won-

dering tonight what I am made of, your sermon O. M. has sure torn a hole in me, I just don't seem to care to listen in, don't know what's the matter, guess I am out of sorts. Well I will listen for your sermon next Sunday. Cul. O. M.

REUNITED

On July 25th the QST was sent out in the regular manner and we were told that Dr. Wells was out of the city. We therefore listened to a venerable Preacher, whose subject was an old one yet ever new—"And a little child shall lead them." The little folks were all dressed in their best bib and tucker. He spoke in part of the innocence and beauty of the child in the home, of the influence for good on the parents. "How often the little child takes the parents' hands and looking up into their care worn faces, says, Good Papa, Kind Mamma." What a soothing effect this little Heaven-sent angel has on our home relations." Boys, if you are a family man, how is it with you are you letting the little one in the home lead you?

Then, on July 28th I received another letter from our radio friend in southern Texas which was of a very pathetic nature and speaks for itself. The letter follows:

Radio Preacher,, 9BW,

Wichita, Kansas.

My dear Radio Preachers Last night I listened-in as usual, copied your sermon, which was very QSA. That was sure some sermon. I never before thought that I would have any use for preachers, but I have changed my mind. Your sermon reached the right spot in my heart if I have any. Say, O.M. I must confess that when I finished copying your QST I was a mess. I bawled like a kid. Well, I'll tell you, I threw the old receivers on the table (Continued on page 312)

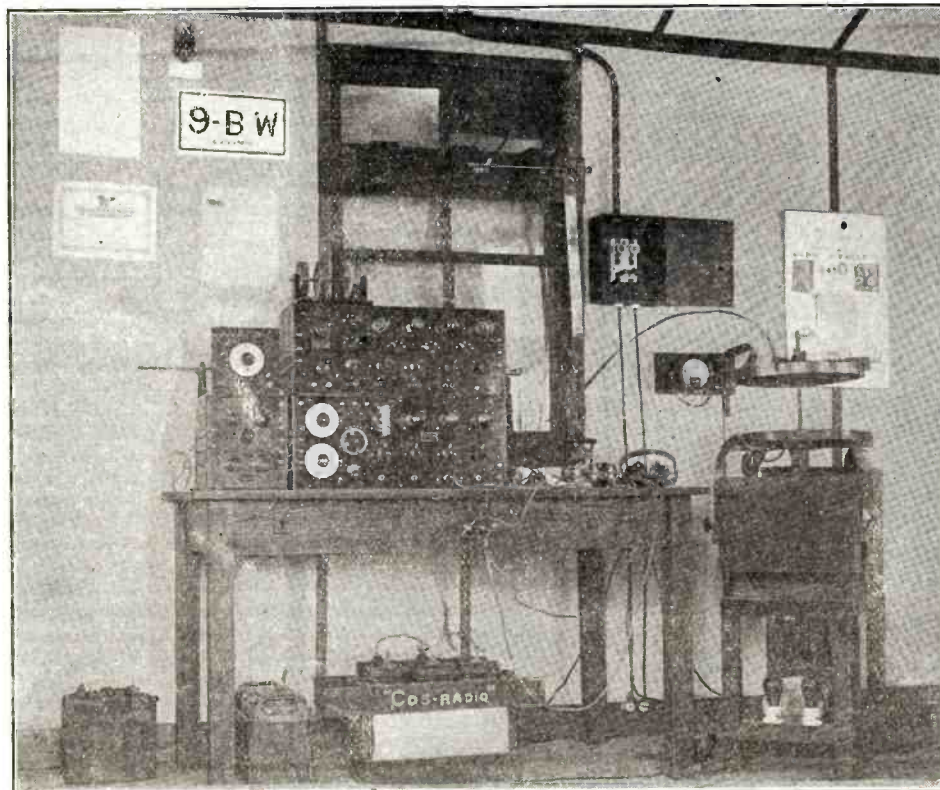

Private Amateur Station of Mr. Stanley, at Wichita, Kansas, Who Has Established a Daily "Q S T" to Local Enthusiasts, Which Includes the Sunday Sermons of Dr. Wells.

The Radio Compass on Merchant Vessels

By ARTHUR H. LYNCH

TWO instances of vessels having been saved by the *Radiogoniometer*,* its value, as well as some of its faults, were recently obtained in an interview with Captain Maxson, of the Morgan Liner "Momus," who disclosed some very helpful information.

A short time ago a Navy seaplane, the F-5-L, flew from Norfolk in a direct line to a battleship, which was at sea 95 miles from land, entirely guided by radio compass. The pilot had no previous knowledge of the warship's whereabouts. The return from the battleship was flown entirely by radio compass direction as well.

Before the signing of the armistice a great deal of radio compass experimentation was carried on by our Air Service in conjunction with the British, especially for use on the huge Handley-Page bombing machines which were to have carried tons of bombs for early Berlin deliveries. The reports upon the practicability of the method used were very favorable at that time.

It is of interest here to recall that the NC-4, in making her trans-Atlantic flight, was directed from one destroyer to the next, from Trepassey Bay, Newfoundland to the Azores, by means of her radio compass.

The use of the instrument on planes also allows them to be certain of locating their landing fields, no matter what the weather conditions may be, providing that intermittent signals are sent out from the field radio station. Guided by their compasses all that is necessary is to fly in the direction from which the signals emanate and judge the distance from the plane's position to the landing field by the intensity of the received signals.

STRIKING EXAMPLES

There recently occurred what was probably the first actual instance of locating a vessel in distress by the employment of the radio compass. The incident is told by Radio Operator L. Leighton, of the S. S. *Bakersfield*.

In order that rescuers could determine the location of the S. S. *Rock Island Bridge*, which was in distress, it was necessary for her to communicate with two land compass stations every fifteen minutes, plot the cross-bearings and determine her position thereby; the same method was resorted to by the *Bakersfield*, and by a comparison of the two positions thus obtained the latter vessel was able to move in the direction of the disabled one. This method of securing cross-bearings from the shore compass stations was the only one which was possible at the time on account of the heavy fog which prevented the steamers from making the usual observations. A very complicated



Captain Maxson Taking Life Easy While the Radio Compass is on the Job. To the Left is Shown Operator Krieger; to the Right is Seen the Loop in Use on Board the "Momus."

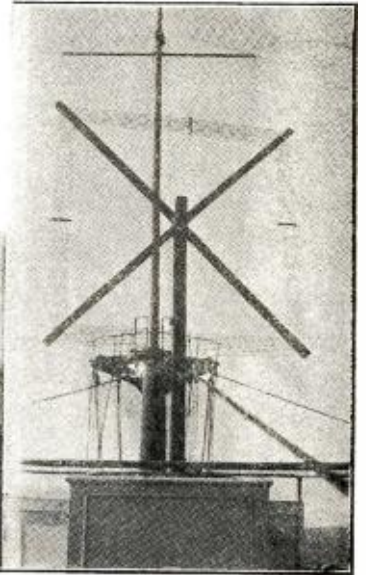

method, indeed, but the only one available and great credit is due the men who were able to perform it.

A very similar instance was disclosed by Captain C. P. Maxson, Commander of the

Both these maritime instances serve to indicate that even with clear weather it is sometimes impossible to figure accurately the position, as well as the fact that the method employed would have been entirely out of the question had the steamers been too far from shore to secure the compass cross-bearings from the U. S. Naval Radiogoniometric Shore Stations. Incidentally the lives aboard these two vessels were saved by radio and the field of radio utility for safety and convenience was again doubly proven.

At this late date, when radio offers the utmost in safety devices for vessels in danger, does it not seem strange that so few vessels are availing themselves of the safety factor afforded by the radio compass? It is true that our government is spending a great deal of money in the establishment and maintenance of the goniometric stations along our coast line. They fill a long-felt need, namely: that of affording bearings and cross-bearings for vessels desiring to enter a harbor in foggy weather and playing the parts outlined above, but they are far from being adequate when the positions of steamers great distances from shore are desired.

Few navigators of the American Merchant Marine are alive to the benefits which may be derived from the proper use of the radio compass, but the first one to display a hearty interest is Captain Maxson, who has used two types of instruments, and his findings are very instructive.

In 1912 when running between New York and New Orleans on the S. S. *Comus*, arrangements were made with the Marconi Company for the installation on his ship of a radio compass, of the Marconi-Bellini-Tossi type. Tests covering a period of six months were made and the greatest error observed by the Captain was six degrees. One of the engineers of the radio company made a round trip and said that the greatest error he observed was five degrees.

When the two triangular loops which form the antenna of this type of goniometer were erected, no particular attention was given to an effort to have the base of one triangle exactly parallel to the ship's keel instead of nearly so and the other loop having its base exactly athwart ship. The Captain is of the belief that more accurate readings would thus have been possible.

(Continued on page 310)

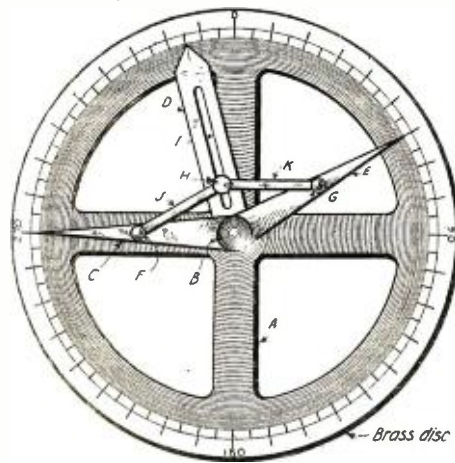
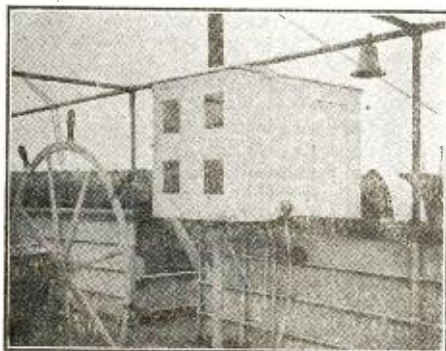

Fig. 1. A Clever Device for the Instantaneous Calculation of Angles Secured in Radiogoniometric and Other Navigational Problems.

S. S. *Momus*, of the Southern Pacific Steamship Company. A freighter was in distress, somewhere in the vicinity of Key West, and her position was accordingly transmitted broadcast. One of the United Fruit ships proceeded to the position indicated, but found nothing of the vessel. The freighter, however, was still above water and was in communication with the fruit ship. A series of messages followed which failed to bring the vessels any closer together. Meanwhile the incident was being closely watched by other vessels within range, and it was at this point that the radio operator of the *Momus* saved the day. He instructed both vessels to secure cross-bearings from shore compass stations; they did so and shortly after the spot of the floundering freighter was found and the crew taken off before she sank. The *Momus*, in addition to being a great distance from the scene, was facing a very heavy sea, and in turning about might have capsized.



The Radio Compass Shack Conveniently Situated On the Bridge of the "Momus." The Loop Rises Directly Above the Center of the Roof.

*Often referred to under the more general names of radio compass or direction finder.

The Invisible Radio Pilot

A Successful Experiment Demonstrating How Audio Frequency Principles May Be Applied to a Positive Method of Piloting Vessels Into Harbors and Rivers During a Fog

By PIERRE H. BOUCHERON

AN interesting demonstration took place on October 6th, which demonstrated the possibility of making use of radio for the piloting of vessels entering harbors during fog. Incidentally the Navy took a prominent place in the staging of the experiment, in fact a destroyer of modern type, the U. S. S. *Semmes* commanded by Commander H. H. Norton was specially detailed for this work.

Strictly speaking this is not a radio story. No statement is to be made concerning a new type of ultra-sensitive amplifier, nor can we make mention of a super-powerful transmitter. However, since a well-known radio principle is employed in this instance, it is both timely and important that radio fans should be given some of the essential details concerned for no one will deny that the present achievement is not due to specific advance of the radio art. Incidentally, Mr. Earl C. Hanson, of Washington, D. C., who has done much research work with audio frequency currents, is largely responsible for the present success of the system.

Perhaps it is not amiss to mention the fact that a great number of prominent men were on hand to satisfy themselves as to the practical features of this latest of Navy development. Such men as Messrs. Lowenstein, Commander McConnell, Expert Radio Aid Crossley, Radio Aid Lang of the Brooklyn Navy Yard, Mr. Clark of the Radio Corporation, a gentleman who suspiciously resembled Mr. E. F. W. Alexanderson of high-frequency generator fame, as well as many others.

The primary object of the demonstration was to show the possibility of piloting vessels thru narrow channels by intercepting a magnetic field, caused by passing an alternating current thru an ordinary submarine cable. In this instance the data given out by the Navy Department may be briefly summarized as follows:

An insulated electric conductor or cable is laid along the line of the fair-way in river mouths or harbor entrances, and a source of alternating current is impressed upon the cable. One terminal of the generator producing the alternating current is connected at the shore end to a ground connection. The other terminal of the generator is connected to the insulated conductor or cable. The terminal of the cable is grounded at a point at the entrance of a harbor or is electrically connected to the outer steel armor, which serves as a

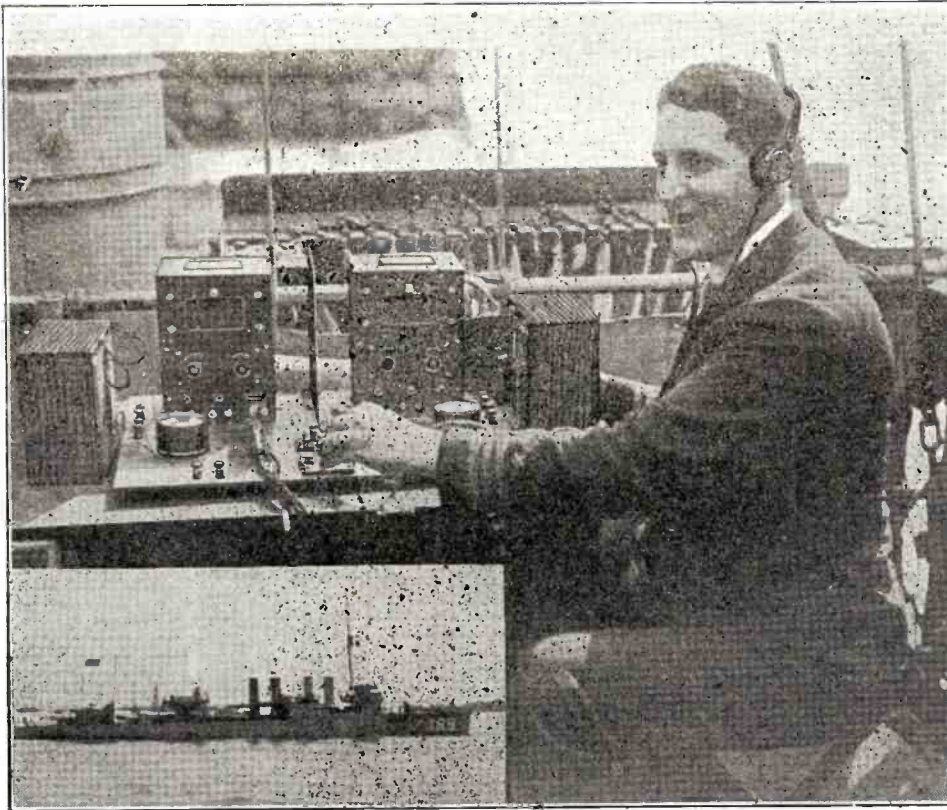

Commander R. McConnell, U. S. N., Head of the Radio Division of the Brooklyn Navy Yard in the Act of Piloting the U. S. S. "Semmes" With the Aid of the Cable. The Insert Was Taken While the Destroyer Was Under Way Off Coney Island, N. Y., and While Directly Over the Cable. Captain S. C. Hooper, U. S. N., of the U. S. Bureau of Engineering is Largely Responsible for His Vision in Applying This War-Time Invention to Peace-Time Needs.

protective sheath to the cable. As is well known it is a fundamental law of electricity that any conductor carrying an electric current produces a magnetic field around that particular conductor. The current producing the magnetic field can be of a direct, pulsating or alternating nature. In this case of course it is alternating.

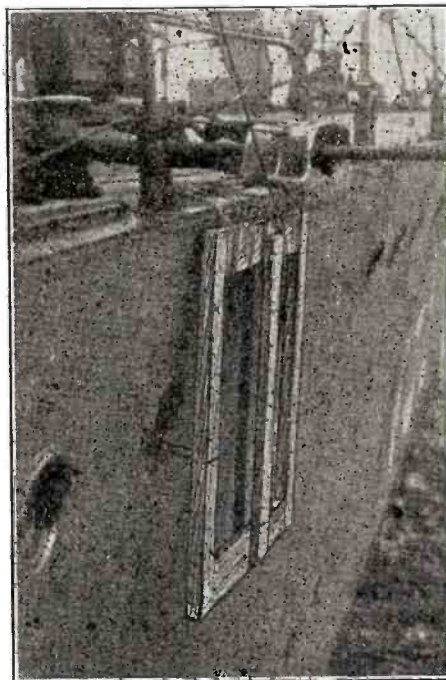

Starboard Loop of the U. S. S. "Semmes" Which is Employed to Pick Up the Energy Radiated by the Submerged Cable.

In the system recently demonstrated, the power source consists of a 1 kilowatt, 500 cycle motor-generator unit installed at Fort Lafayette, a small Naval magazine located near Fort Hamilton, at "The Narrows," New York Harbor, which delivers approximately 3.5 amperes of current to the cable at 375 volts. This current is in turn interrupted by an automatic transmitter spelling out the word "NAVY" in the Continental Morse Code, in order that the signals may be readily distinguished from possible nearby legitimate radio signals.

The apparatus used for the reception of signals consists of two coils of several hundred turns of small copper wire wound in the form

of a square, in the manner shown in one of our illustrations. The coils are each connected thru a D.P.D.T. switch to a two-stage vacuum tube amplifier in which instrument the current induced in the coils by the rise and fall of the magnetic field with each alternation of the 500 cycle supply current, is magnified approximately 400 times. Being of an audible frequency it readily acts on the diaframs of the telephone receivers worn by the navigator on the bridge of the vessel as may be seen by referring to the larger photograph on this page.

In view of the fact that the direction of the field is *concentric* to the cable and that its intensity is greatest in the center of this field or directly around the cable, it is obvious that the strength of the received energy will vary with the distance of the coils from the cable.

The intensity of the received energy also varies with the position of the coils in respect to the magnetic field, it being greatest when the plan of the coil is parallel to the cable. In approaching the cable, the signal will first be heard in the coil on the side nearest the cable owing to the shielding effect of the vessel's hull. This renders the system directive to the extent of being able to determine on which side of the vessel the cable lies, this fact being readily ascertained by throwing the D.P. D.T. switch from the port to the starboard coils or vice versa.

After settling on a course which is parallel to the cable, the vessel may assume a position directly over the cable, which is indicated by a maximum and equal signal in each coil or may carry a maximum in one coil, preferably the port coil, which

(Continued on page 306)

Effective 150—20,000 Meter Reception

Some Excellent Data Concerning a Combination Short and Long Wave Receiver
Embodying Stagger-Wound Inductances

By D. R. CLEMONS*

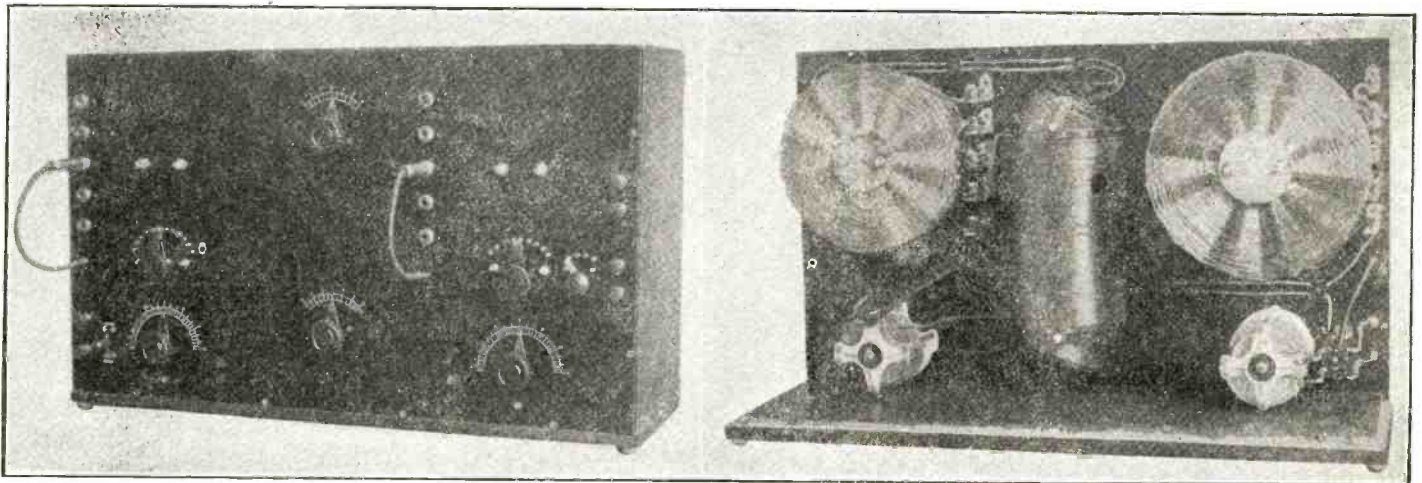

Front and Back View of the Complete Receiving Unit Making Capable the Reception of Waves Ranging from 150 to 20,000 Meters. The Feature of This Set is That When Receiving on Low Wave Lengths All Unused Inductance is Cut Out and "Dead Ended"; This Being Accomplished by the Plug and Jack System Shown on the Panel.

THIS descriptive article accompanied by photographs and diagrams deals with a recently constructed equipment designed and built by myself for practical usage over all wavelengths between 150 and 20,000 meters wavelength.

This equipment operates over the entire range of wavelengths without distortion, frequency changes, variation or local reactive disturbances of any kind. It is composed of a combination of three bands within one cabinet; each effectually "dead-ended."

While I do not claim any new features within this equipment, I should like to see such equipment appear in the many stations whose owners are desirous of such effective equipment. For this reason, the accompanying photographs and prints may serve as a guide for those who are without information of any sort.

There are many problems which confront the builder of receiving equipment. Ordinarily these problems concern new and unnecessary devices that not only affect the reliability of the set, but are also an expense that might have gone to more important portions of the receptor. After many years of experimenting, the real goals become simplicity and efficiency combined. One should not be sacrificed for the other in any case.

Amateurs now desire to receive all

stations available to them. This requires receptors capable of adjustment over wavelengths of 150 to 20,000 meters. It is a great advantage to possess a receiver of sufficient range for such reception. A receiver of such proportions becomes even more desirable when contained within a single cabinet. Transmitters of larger power now employ continuous waves for transmissions over great distances. For the efficient reception of these, the receiver must be provided for undamped reception. The set may also be regenerative on spark signals.

The instruments to be described are a receptor of 150 to 20,000 meter range, and a detector-amplifier unit of two stages.

In the receiver illustrated, all unused in-

ductance is cut out and "dead-ended" when any value below maximum is added to the circuits. Normally, the total value of inductance is in the circuit. Plug and jacks are employed for adding and "dead-ending" values of inductance. The units used singly and together provides ranges of 150-900, 900-6,000, 6,000-20,000 meters, respectively.

A key switch places a variable condenser in series or shunt to the primary system when tuning on very short or long waves, as the case may require.

The autodyne method is used for undamped reception. An inductive feed-back is provided for generating local oscillations. The set becomes regenerative by suitable adjustment of the tickler coil. This

adjustment is valuable for spark reception.

Self-balancing variable condensers are used in both primary and secondary.

Coupling between the antenna and detector circuit is effected through a small bank-wound inductance mounted below the secondary system. Both tickler and coupling coils are mounted in brass bushings at the ends of the secondary solenoid. A friction bearing holding each in any position.

For both loading systems, flat spiral stagger-wound inductances are used. Nine of these unique coils are used for the primary—four of these being of smaller radius to provide space for (Cont. on p. 316)

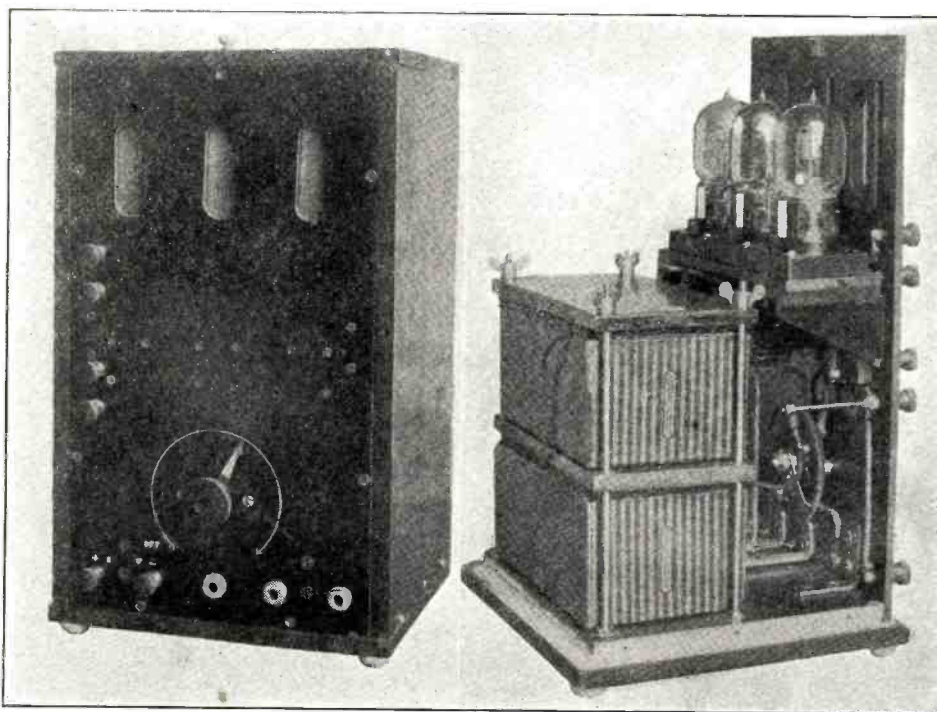

Detector-Amplifier Unit Which Mr. Clemons Has Employed in Connection with the Short-Long Wave Set Shown in the Above Photograph. Note Well the Ingenious Manner of Securing the High Voltage Plate Batteries to the Base of the Instrument.

*Radio Instructor Dodge's School.

Electron Power Tubes and Some of Their Applications*

Part 2

By WILLIAM C. WHITE

Research Laboratory, General Electric Company

OSCILLATING CIRCUITS FOR POWER TUBES.

A great deal has been published on this subject and the principles involved are pretty widely understood. However, such publications have dealt mostly with receiving circuits in which the requirements are somewhat different.

Some general considerations from the viewpoint of power-tube operation will be given and these points explained in connection with a typical circuit.

In practically all the forms of oscillating circuits used at the present time three fundamental adjustments are necessary in order to get full output at the best efficiency and desired frequency. In some forms of circuits the variation of one factor will change another, making the complete adjustment a complex matter.

These three fundamental adjustments are:

(1) Variation of inductance or capacity or both in the resonance portion of the circuit to obtain the frequency desired.

(2) Adjustment of the ratio of transformation between the plate circuit and the load circuit.

(3) Adjustment of the voltage value, phase relation and normal d-c. potential of the energy fed back to the grid for self-excitation.

The first and probably the third of these adjustments are well known and need no further explanation; but the second one, the adjustment of the ratio of transformation between the plate circuit and the load circuit, is not as well understood as it should be.

Since power tubes are used mostly for radio transmission, an antenna as a load will be considered.

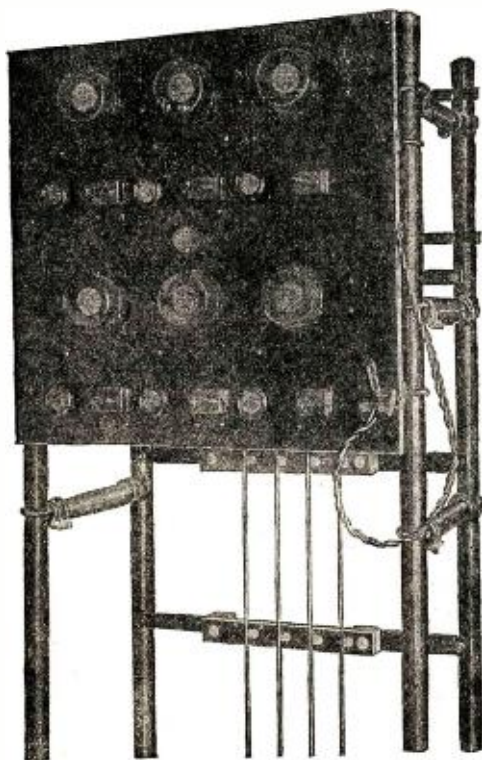

Fig. 8. Plotron Unit Panels Containing Only Plotrons and Individual Control Apparatus.



Fig. 7. Plotron Panel for 50,000 Cycles.

For energy calculations the antenna may be replaced by a resonant circuit having concentrated inductance and capacity. In an artificial circuit of this sort the energy radiating property of the antenna is replaced by a resistance and it is customary to consider a resistance in series with the inductance and capacity rather than a higher resistance shunted across the two.

For instance, ten amperes flowing in an antenna circuit of 0.001 microfarad and one millihenry at the resonant frequency of 159,000 cycles (1885 meters wave length), will give an energy dissipation of 1000 watts if the series resistance is ten ohms. An equivalent dissipation in energy would take place if the series resistance of ten ohms were replaced by a resistance of 100,000 ohms shunted across the capacity.

For every condition of operation of a three-element tube as an amplifier or oscillator, there exists a particular value of plate impedance and the use of this value of resistance in the plate circuit will give a maximum output of energy. This is a well known fact and has been brought out by many writers.

Now supposing the normal operating impedance of the tube to be 5000 ohms, it is very apparent that the voltage generated by the tube is not at all suitable for direct excitation of the antenna. Therefore, a transformer or its equivalent must be placed between the plate circuit and the antenna circuit.

In the case mentioned the ratio of transformation between impedances of 5000 and 100,000 would be the square root of this ratio or approximately 1 to 4.5.

The actual turn ratio would be considerably higher than this, owing to the fact that in most radio frequency transformers the voltage ratio falls below the turn ratio.

An equivalent to a step-up transformer is a variable coupling, but in this case the plate circuit must be made resonant by the addi-

tion of a capacity shunted across the plate inductance.

In order to get full output from a tube it is necessary to have only resistance effective in the plate circuit. Any excess value of inductive or capacity reactance means a heavier current for the same energy delivered (the so-called wattless component) and this component gives an added loss in passing through the necessary impedance of the filament to plate path in the tube.

In any circuit built to energize an antenna at a number of quite widely different wave lengths, this ratio must be varied for each wave length in order to get best results, because the effective antenna resistances will vary. The tube impedance under fixed operating conditions remains quite constant except thru very extreme ranges of frequency where the capacity effects between electrodes becomes appreciable.

One form of typical oscillating circuit quite widely used for energizing a radio transmitting antenna is shown in Fig. 4.

The first variation mentioned, that of change of inductance or capacity to get the desired wave length, is accomplished in this case by variations of the inductance of L_A .

The inductance L_p and L_a have a fixed close coupling and the second adjustment, that of variation in ratio, is accomplished by variation by taps in the number of turns of L_p . In most cases the ratio of L_p to L_a is a step-up one; but if the tube impedance is unusually high and the antenna resistance (expressed in the usual way as equivalent series ohms) rather higher than the average, the ratio in the direction as above stated may be slightly step-down.

If a direct current ammeter is placed in one of the leads from the direct current source E_b , so as to indicate the average

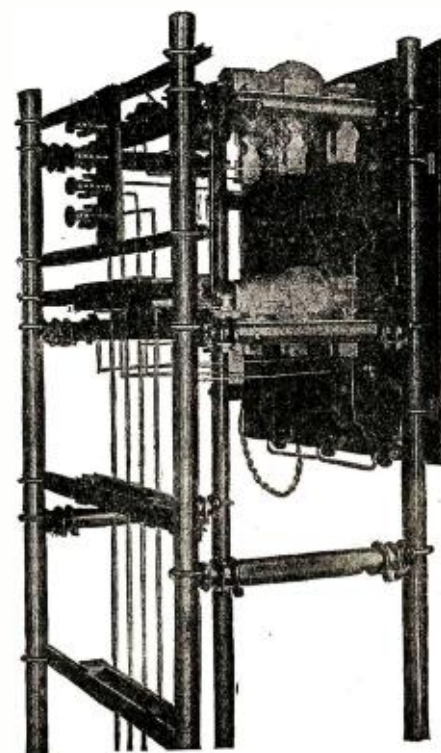

Fig. 9. Rear of Panel Shown in Fig. 8.

*Part 1 of this paper appeared in the October number of RADIO NEWS.

plate current I_b and an ammeter inserted in the antenna it is very easy to set the transformer ratio at the proper value.

Starting with a large number of turns on L_p , other adjustments being properly made, both the value of plate current I_b and antenna current I_a will be low.

As the number of effective turns on L_p is decreased the values of I_b and I_a rise. Since E_b is held constant while antenna voltage increases with increase of I_a , the rate of increase of I_a will be less for a constant value of efficiency.

In most cases of high voltage power tubes, the adjustment is made for best efficiency considering the maximum safe load on either the tube or the source of supply at E_b . In either case the value of L_p is ad-

justed until the ratio of $\frac{I_a^2}{I_b}$ is a maximum.

If the number of effective turns of L_p is decreased beyond the best point there will be an increase of I_b with little or no increase in I_a . Finally, if the number of effective turns of L_p is unduly decreased, the oscillations will usually stop and I_b take up a value dependent upon the static characteristics of the tube.

Of course as in the case of transformer design at commercial frequencies it is not only the ratio of turns between L_p and L_a

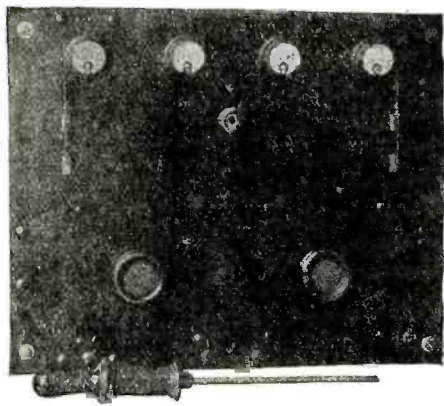

Fig. 10. Power Control Panel for Use with Pliotron Units Shown in Figs. 8 and 9.

that is important, but also the actual number of turns used on the coil L_p . Too few turns will give an excessive exciting current relative to normal load current and too many turns an excessive impedance to the load current. Owing to the fact that air with its uniform magnetic permeability is usually used for the magnetic circuit of the coils the permissible range of design variation is increased over that of commercial frequency transformers.

If a variable coupling between L_p and L_a is employed rather than variable turn ratio, a condenser must be placed across L_p to form a resonant plate circuit if full output is desired. If this condenser or an equivalent is not used there will be an excessive inductive reactance in the plate circuit.

The third adjustment, that of grid excitation voltage, is accomplished by variation of L_g , its coupling to L_a and the value of R_g (see Fig. 4).

In the actual arrangement of a circuit of this type incorporated in a finished piece of apparatus, there are several features which are of interest.

In radio telegraphy the telegraphic dots and dashes require rapid make and break of the energy to the antenna. This is usually accomplished by placing a key in series with the high grid resistance R_g of Fig. 4. In this way it is only necessary to make and break the relatively low current and low potential of the grid circuit. Opening the circuit at this point allows the condenser C_g to charge up so as to give the grid a high negative value of potential, thus cutting off the flow of plate current to the tube which

Fig. 12. Rear View of 30-Tube Pliotron Panel Shown in Fig. 11.

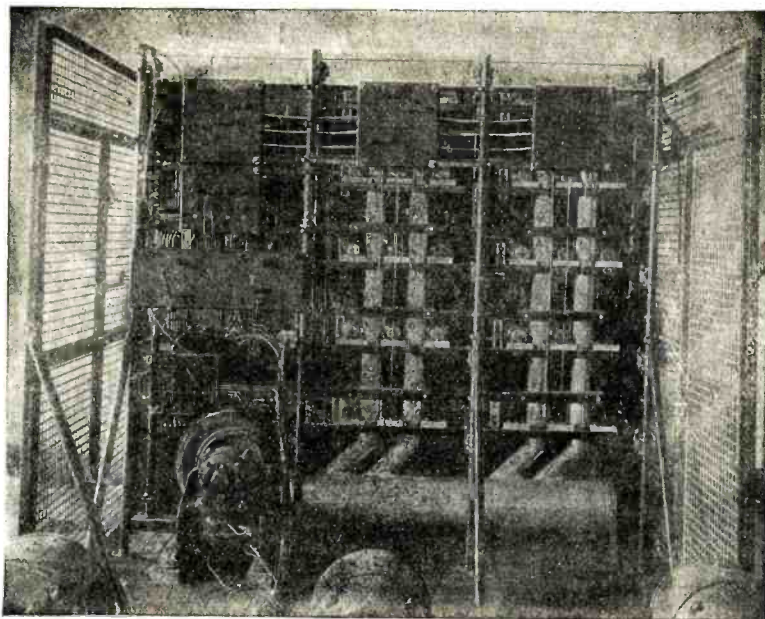

in turn reduces the input and therefore the output to zero.

Now, the condenser C_g has usually a small value of capacity of the order of a few hundred micro-microfarads. Therefore, the rate of its charging up and the resultant rate of decrease of the plate current I_b is extremely rapid, much more rapid than the opening of a pair of contacts because there is no arcing or sparking.

In most power tube work the source E_b is a high voltage, direct current generator. In such a machine the number of turns in an armature coil is large and therefore the armature inductance is high. If the flow of current thru this inductance is suddenly interrupted there naturally follows a considerable step-up of voltage across the armature terminals.

Therefore, there is an abnormal instantaneous voltage strain liable to cause a breakdown, which breakdown of insulation usually occurs between some point on the armature coil near the plus end and the core of the armature, because the negative armature terminal and frame are at, or near, ground potential.

As an example, a certain more or less standardized form of high voltage direct current generator rated at 1,500 volts, 2 kw., 1,800 r.p.m., had an armature inductance of approximately one henry. The full load current was 1.33 amperes and it is readily seen what a high surge of voltage was caused when this current was brought to zero in a very small fraction of a second.

It is therefore necessary to put some form of protective device across the terminals of E_b which will pass current when the voltage arises above a certain predetermined value.

Aluminum cell lightning arrester equipment* has proved to be an excellent form of protective device and it has been found advisable to use them

when the energy input exceeds 500 watts at 500 volts or over. For the lower powers a condenser of as large a value as practical should be shunted across the source E_b .

When a circuit is incorporated in a finished piece of apparatus in which the wiring is more or less complicated by the requirements of operation, it is often noticed that the adjustments, particularly that of the grid excitation, are more critical than in a similar but simple experimental circuit. This can be usually accounted for by the capacity effects between adjacent wires and inductive effects between wires of different circuits which are naturally closer spaced and of greater number than on an experimental layout.

In operating tubes of the larger type in parallel it is usually advisable to include a fuse and ammeter in the plate circuit of each tube. The ammeter allows the location of a defective tube to be noted and the fuse throws out of circuit a tube drawing excessive current.

In the parallel operation of tubes, trouble is often experienced with sudden values of

(Continued on page 318)

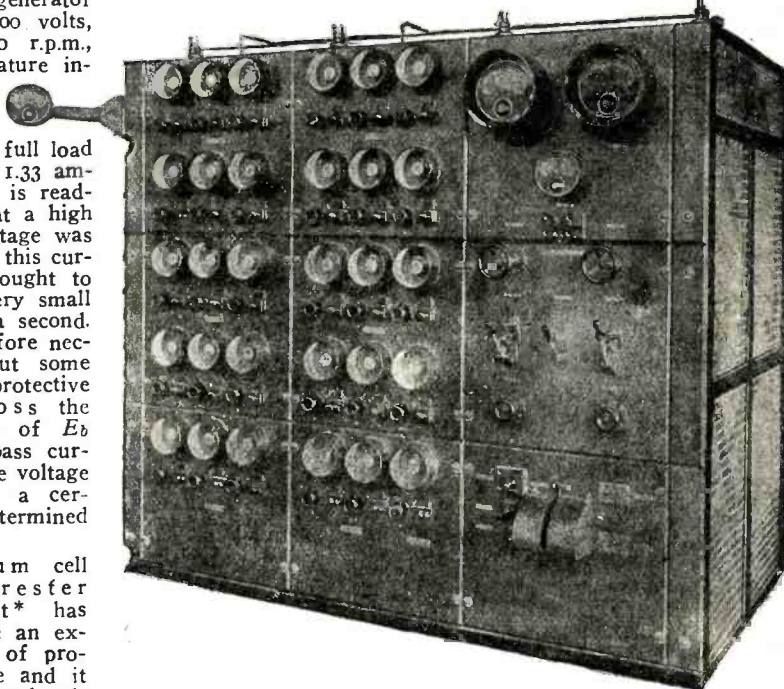

Fig. 11. Thirty-Tube Pliotron Panel, a Back View of Which is Shown Above.

* "The Construction and Maintenance of Aluminum Cell Arresters," by R. T. Wagner, *General Electric Review*, Vol. 16, January, 1914.

Registering Radio Messages on Tape

Are the Familiar Head Telephone Receivers Doomed?

HERE is a device which promises some interesting developments in future radio and which involves not only professional but amateur stations as well. Just think of tuning your receiving set to the broadcast wave of NAA or any other station sending valuable information and by means of the present device, being able to secure a graphic record of the complete matter transmitted, without the necessity of your presence at the instruments.

Such is the claims of a device recently invented by Mr. William G. H. Finch, an experimental engineer of Buffalo, New York, and who incidentally has been granted a patent by Washington. The radio recorder which is shown in the accompanying photograph sends with an ordinary tape register similar to those employed on regular telegraph lines. This feat is made possible by the employment of a super-sensitive relay which is designed and constructed along entirely new lines and which will function by the action of remarkably weak electromagnetic impulses. This relay in turn closes the circuit of a second relay which controls a somewhat heavier battery current necessary for the operation of the tape recorder, or whatever other device may be connected in the circuit. Thus incandescent lamps may be lit, motors started, horns operated, and bells rung by this system with ease and simplicity.



William G. H. Finch, the Inventor of the Radio Signal Recorder. The Illustration Also Shows the Essential Instruments Connected With the Successful Operation of the Device. It is Claimed for This Invention That it Will Accurately Register on Tape Radio Signals up to 2600 Miles When Employing a Vacuum Tube Receiver Circuit.

HOW IT WORKS

Fig. 1 shows a schematic wiring diagram which will give you a general idea as to how the device operates.

The radio circuit is brought to a point of resonance in the customary manner by the use of variable inductances and capacities. A detector and a pair of head phones are used to "tune in." Both of these may be switched out of the circuit when it has been brought to resonance.

Maximum current will then flow thru the special relay device which will in turn operate the second or heavy-current relay mentioned before.

Under test this new relay worked perfectly over surprising distances and when used in conjunction with other efficient apparatus it can be depended upon to render very good service. It is simple and there are no unduly delicate parts exposed. By using the special relay in connection with at least one audion amplifier the distance over which it will operate can be increased considerably. With several stages of amplification the relay will operate over what might be termed long distances.

Radio engineers have long been endeavoring to perfect a device that would function on very weak currents and if the present development proves successful it will certainly receive a good welcome. It is well known, of course, that the English engineers of the Marconi Co. recently perfected a device along these lines that operates a bell upon the receipt of a radio distress signal at sea and which we reviewed in these columns some months ago. This is to be employed for emergency use only and will not be used for ordinary communication. The fact that the Marconi Co. has been interested in this problem proves that its importance to the field is well recognized.

(Continued on page 308)

OUR TITLE CONTEST

AS you probably have guessed, it is not the easiest thing in the world to get up a cover for RADIO NEWS. Ever since the inception of the magazine, the editor establishes the policy to present one month a technical cover, and alternate it next month with a "human interest" cover. The underlying idea is that if we ran technical covers all of the time, we would probably not attract new "bugs" to the game, whereas we have found that our "human interest" covers attract many people in all walks of life who otherwise might not become interested in radio. Thus we found that we fulfill our mission by making the radio art known to more and more people every day.

Now, then, a cover is not the only thing which your editor has to worry about once a month, while he revolves at a high frequency in his bed. Not only must he think up the cover for the magazine, but he must provide a suitable title for the picture as well. Sometimes these titles come in with tolerable audibility, but frequently the mental static is bad, and the whole system seems grounded.

So last month when your editor got up a front cover, everything ran along smoothly, but when the selection of the title came around, the psychic detector adjustment was K. o'd., and no sensitive spot could

be discovered in our whole mentality. Everything was as dead as a burnt out V.T. "Sigs" were entirely missing, while there was a goodly amount of Q.R.M. go-

\$50.00 IN PRIZES

WILL you supply the missing title to our front cover of this issue?

The following prizes await the winners:

- 1st Prize \$25.00
- 2nd Prize \$15.00
- 3rd Prize \$10.00

Study the titles on our former covers and see how a long story sometimes is expressed in three or four words. Why not try your hand for a little easy money?

—Editor.

ing on inside of our think-box, which made the "reception" even harder. So the editor gave it up as a bad job, and declared that he would "let George do it."

Hence the cryptic dollar marks in lieu of a title on our front cover this month. Perhaps you can tell us what our cover is all about. Frankly, we do not know, and what is more we do not care: it's your

magazine—we never read it! We have a vague and hazy idea of the action of the "plot," but somehow or other our key is sticking badly and we are not in a position to "Q.S.T." the title as of yore.

Suppose you try and see what you can do to supply the missing title. We too thought it was easy at first. Perhaps you'll find it so after all. Everybody can compete, and there are no restrictions save that *there must not be more than eight words to the title.* Furthermore, the title must be explanatory of the picture, and the fewer words you use the better. If you can do it in three words, we'll like you all the more. The prize winner will be awarded \$25.00, the second best title will be awarded \$15.00, while the third best title will receive \$10.00. The editors of RADIO NEWS will be the judges of the prize titles.

If more than one person submits the winning titles each will receive the prize offered.

Contestants are not restricted from sending in more than one title. They may send in as many as they wish. It is also self-understood that the title must be of a radio nature to fit in with the picture. This contest will close in New York on December 10th. The prize winning titles will be announced in our January issue.

Address all to

TITLE EDITOR RADIO NEWS

New Amplifying Apparatus*

Some Interesting Units Embodying the Automatic Filament Control Feature

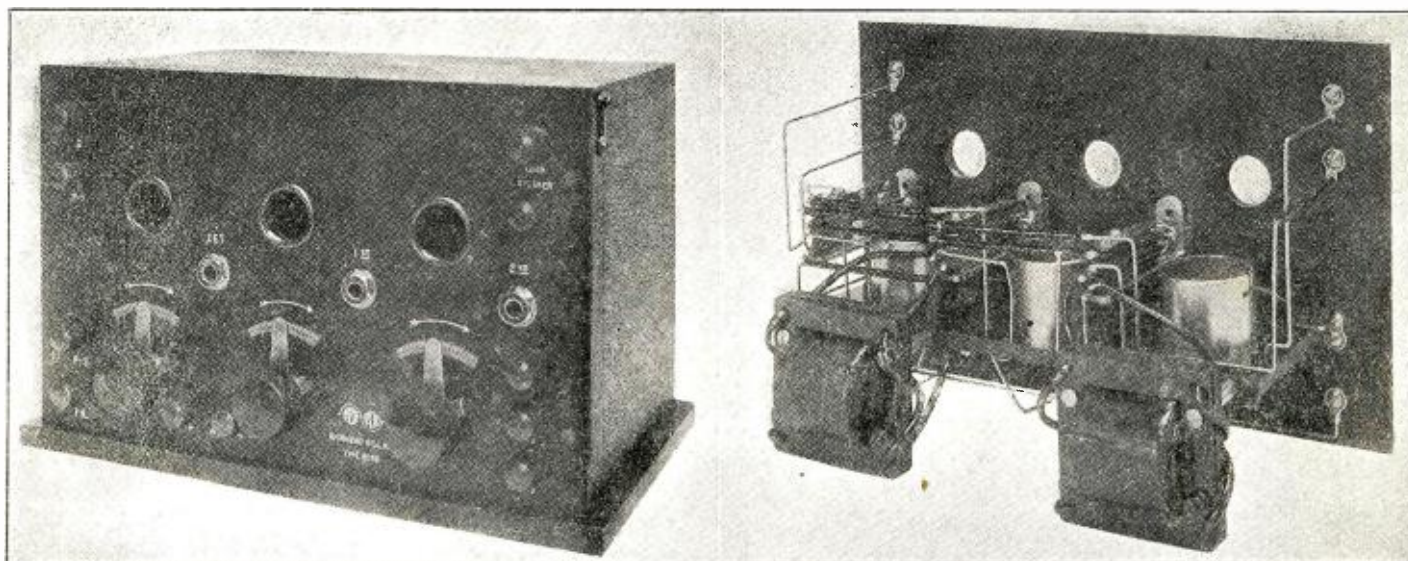

To the Left We Illustrate the Panel View of This Important Unit Employing Detector and Two Stages of Audio Frequency Amplification. To the Right is Shown "the Works." This Instrument is Unique in That it is Fitted With Automatic Filament Control as Described in this Article. This Type of Apparatus Represents Up-to-the-Minute Operating Efficiency.

IN times past, before the fundamental truths about the designs of radio apparatus were known, but little effort was put forth towards the perfection of convenient operating control features. Undoubtedly this was partly due to the encouragement given to the design and construction of freak apparatus having the greatest possible number of adjusting knobs all for a single purpose. In many instances half of the knobs or other forms of adjusting devices could be removed from the apparatus without sacrificing any of the necessary adjustments. Behold, this is all rapidly becoming ancient history.

The critical radio man of today will have none of this "Ginger-bread" design and will listen to no alibis of "High Efficiency" in an attempt to camouflage poor design and workmanship. In fact he is looking eagerly towards the time when the operation of a radio station will involve much less juggling of apparatus.

In the design of this type of apparatus* the necessity for convenient operating control has always been kept in view and it is but a natural outcome of concentrated effort in this direction that has produced the

AUTOMATIC CONTROL feature. This system as applied to all apparatus which includes more than one vacuum tube, places it on a high plane of operating as well as electrical efficiency. The system gives the operator instant control over the vacuum tube circuits and also effects an

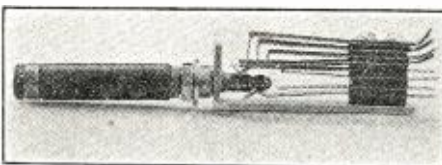

The Plug and Jack and Method of Contactors Making Automatic Control Possible.

appreciable saving in the life of both vacuum tubes and batteries—a most desirable factor.

As a specific example, attention is directed to the detector and two stage amplifier circuit diagram of Fig. 1. It will be noted that the insertion of the telephone plug into the jacks corresponding to the

detector, first stage and second stage positions will cause the filament circuits of the corresponding vacuum tubes to be lighted. Thus with the plug in the detector position, the filament of the detector tube is lighted. With the plug in the first stage position the filaments of the detector and the first stage amplifier tubes are lighted and finally when the plug is in the second stage position, all three filaments are placed in operation. This means that the initial adjustment of the individual filament rheostats may be left undisturbed permanently and subsequent control of all the stages can be accomplished by merely inserting the plug into the proper jack. As an additional feature, provision is made for transferring the output of the second stage amplifier to a set of binding posts marked "loud speaker," see Fig. 2. This transfer is made by inserting the plug only part way into the second stage jack which causes the filaments to be lighted but leaves the telephone disconnected. This position is indicated by a marked unmistakable click caused by a turned groove in the end of the telephone plug.

(Continued on page 322)

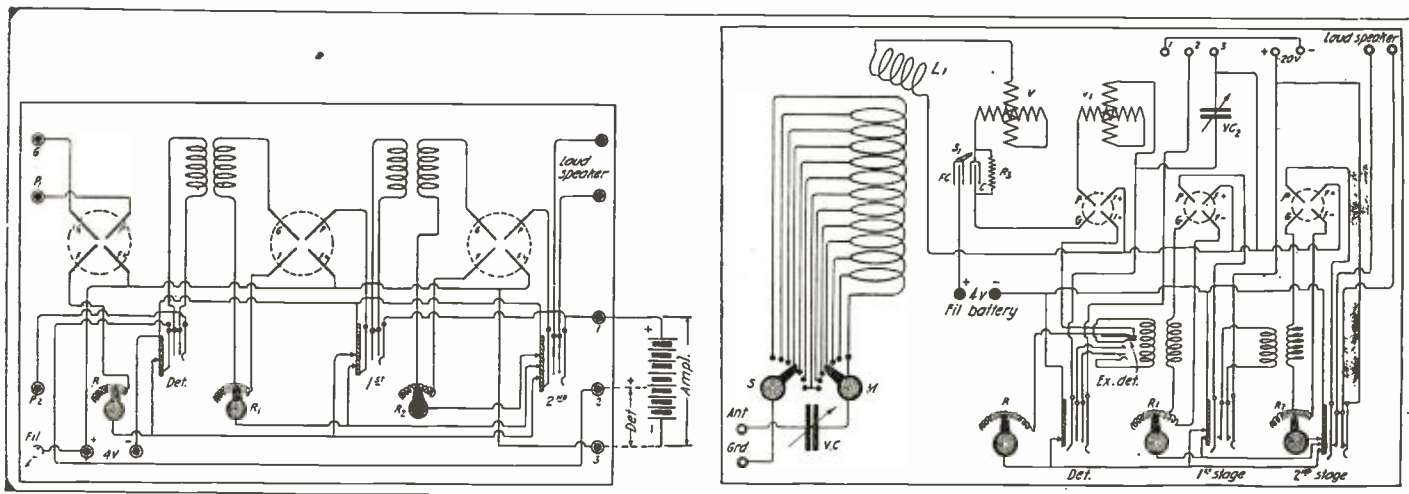

The Left-Hand Diagram Illustrates the Wiring Hook-Up of the Detector-Two-Step-Amplifier Unit Shown in the Above Photograph. While the Right Hand Diagram Shows the Rather Interesting Hook-Up of a Short Wave Regenerating Unit of Same Manufacture and Which is Equipped With the Same Control Feature.

*Illustrations by courtesy of A. H. Grebe & Co., Inc.

Electron Tube Transmitter of Completely Modulated Waves

By LEWIS M. HULL*

IN order to utilize a radio-frequency oscillation of given power most effectively in a non-oscillating receiving system, it must be completely modulated, the periodic reduction of the current to zero occurring at a suitable audio-frequency. Radio-frequency harmonics, manifested by distortions in the shape of the radio-frequency or carrier wave, limit the total power radiated by a transmitter at a single frequency to which the receiver

times per second while the supply voltage falls from 0 to $-E_b$ volts. The antenna current is maintained for a half cycle when the plate is positive and is reduced to zero a greater part of the half cycle when the plate is negative.

The first method requires a source of high direct voltage which may be inconvenient if high-power tubes are used. With the second method the whole system can be operated from any audio-frequency gen-

ters; (3) a readily adjustable range of wavelengths from 500 to 1,000 meters; (4) transmission of completely modulated waves, making possible their reception with crystal detectors; (5) sharply tuned waves, in order to avoid excessive interference over long series of tests. The set has been used in fog signaling and direction finding experiments, and in transmission tests carried out as part of an investigation of wave propagation.

Front and Back View of the Complete Set Assembled in the Radio Laboratory of the Bureau of Standards at Washington, D. C.

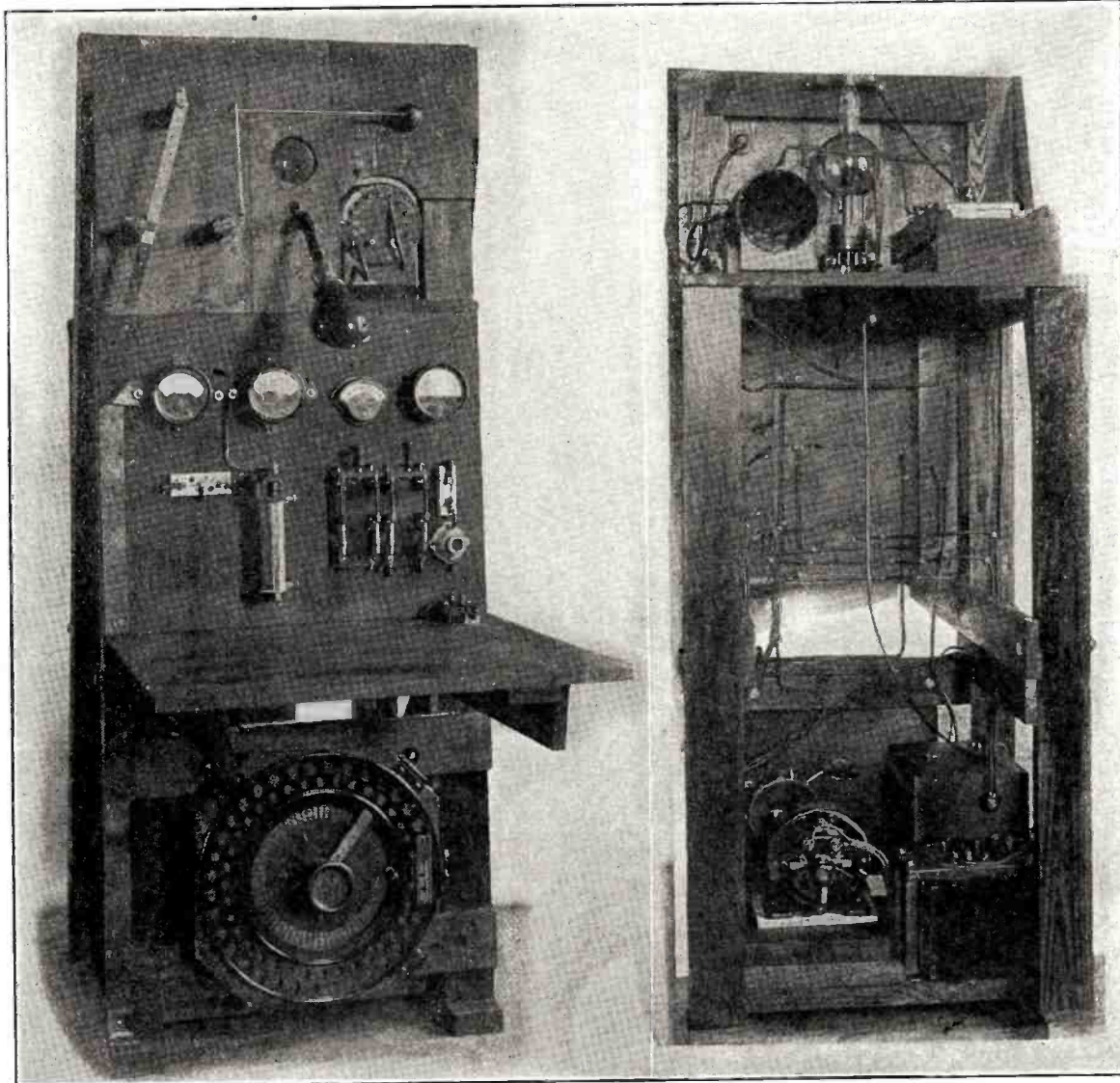

This Particular Set Was Assembled Upon a Panel Designed for a Different Purpose and Might Have Been Constructed in a More Compact Form.

is tuned. Audio-frequency harmonics, manifested by distortion in the envelope of the radio-frequency oscillations from sinusoidal form, determine the response of any amplifying and rectifying detector.

There are two possible methods of operating an electron-tube generating system so as to furnish a completely modulated output: (1) The use of a direct supply voltage in connection with a mechanical interrupter or "chopper," which periodically breaks the supply circuit, causing the antenna current to be reduced to zero; (2) the use of an alternating audio-frequency supply voltage. If the frequency of the supply voltage be F and the peak value E_b , then the plate is positive with respect to the filament F times per second while the supply voltage rises from 0 to E_b volts, and negative F

times per second while the supply voltage falls from 0 to $-E_b$ volts. The antenna current is maintained for a half cycle when the plate is positive and is reduced to zero a greater part of the half cycle when the plate is negative.

A transmitter of this description has been designed and built at the Bureau of Standards. The set fulfils the following requirements: (1) Use of a single Type "P" pilotron, with 500-cycle, 150-volt alternator; (2) power output exceeding 200 watts in an antenna having 8 to 15 ohms resistance and a natural wavelength below 200 me-

In designing the set the average power output in a given antenna was taken as the criterion of its merit as a transmitter of radio waves. The kind and degree of modulation of the waves radiated determine to a large extent what type of receiving circuits should be employed to utilize this power effectively. However, if it be understood that an appropriate receiving circuit is to be used, the effective current output in an antenna of given radiation resistance at a given wavelength determines the merit of any transmitter of modulated or unmodulated waves.

Fig. 1 is a diagram of connection of the final form of this transmitter as put into service for radio direction finding and fog signaling.

Owing to the fact that the 500-cycle voltage, when using a 2-K.W. alternator, drops

*Associate Physicist Bureau of Standards.

enough to decrease the filament current by as much as 15 per cent when the load was thrown on in the plate circuit, it was found necessary to include in the filament transformer a series compensating winding. This is rendered doubly imperative by the fact that when operating a tube at high plate voltage, the power output changes to a much greater extent with slight changes in emission than when operating at lower plate voltages. The system is always kept adjusted for maximum output at the maximum safe filament current, I_1 effective = 3.6 amperes, and even a slight decrease in this current decreases the power output considerably, and the current output to a corresponding extent. In order to be able to adjust this transformer to give suitable compensation for the drop in primary voltage, and still be able to use it at different values of generator voltage, when it is found desirable to transmit at reduced power, it is necessary to make the number of turns in the compensating winding adjustable. The compensating winding of the transformer is composed of 100 turns No. 16 d.c.c. wire, with a tap every twelve turns from 30 to 100. The filament rheostat makes it possible to adjust the filament current for any steady value of primary voltage on the transformer; the series compensating winding makes it possible so to adjust the transformer to the supply circuit that the filament current reaches a safe maximum when the load is thrown on. If sufficient power is available from the generator it is advisable to over-compensate the transformer, making it possible to heat the filament at reduced current except when the key is pressed.

EXPLANATION OF CIRCUIT.

Fig. 1 is a diagram of connections of the modulated wave transmitter, and the following data covers the explanation of the designating letters shown: *A.* Plate and grid coupling coils. Continuous coil wound on fibre tube 5½ inches in diameter. Eighty turns No. 18 solid wire spaced ½ inch apart; and taps brought out every five turns on grid side and every ten turns on plate side of coil. *B.* Antenna switch. *D.* Generator field rheostat. *E.* Electron tube, Type P pliotron. *F.* Antenna coil; 30 turns-litzendraht, wound on fibre tube 6¾ inches in diameter; taps brought out every two turns; mounted so as to slide over coupling coil, in order to vary mutual inductance. *G.* Stopping condenser; mica; $C = 0.004$ mfd. *H.* Automatic sender, driven by D.C. motor, which is supplied from the field circuit of alternator. *I₁*. Filament ammeter. *I₂*. Antenna ammeter. *R.* Filament rheostat. *T.* Supply transformer, 2 K.V.A.; ratio of turns, 40/1; full load voltages, 160/6,500. *T_f*. Filament transformer, special construction. The main windings consist of 200 turns No. 16

Diagram of the Complete Connections Employed in the Modulated Wave Transmitter, the Constants of Which Appear Under the Caption "Explanation of Circuit" on this Page.

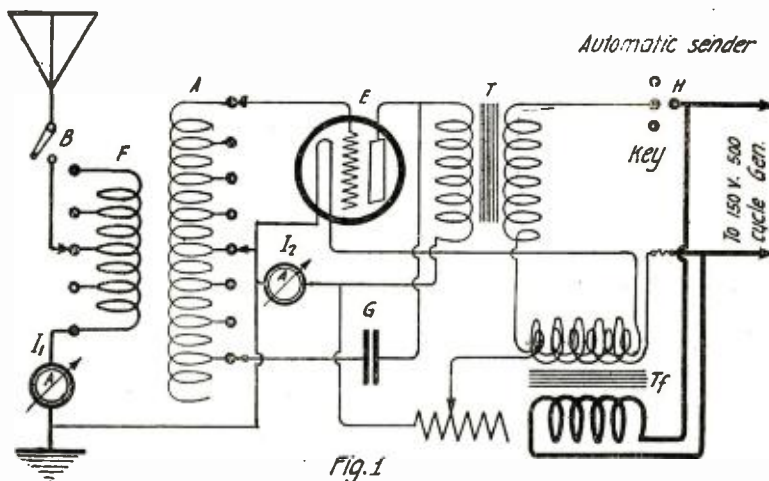

Fig. 1

d.c.c. wire on the primary side, connected across the 180-volt supply, and 120 turns No. 16 d.c.c. wire on secondary side, connected to filament circuit.

The transmitter described in this paper was designed to operate at short wavelengths. The performance of such a system at short waves is limited by two factors; first, the electrostatic capacity between elements of the electron tube, which may pro-

sist at short wavelengths, particularly in view of the fact that the total effective resistance decreases with increasing frequency.

When supplying an antenna having a capacity of approximately 0.004 microfarads and a resistance of 10 ohms, this set gave a power output in the antenna of 286 watts at 600 meters wavelength, using an effective value of filament current of 3.5 amperes, and operating at an overall efficiency of 35 per cent, alternator terminals to antenna inclusive. This efficiency takes account of the power expended in the filament supply transformer and in the filament. No data are available on the efficiency of the tube alone, as ordinarily computed in terms of input to the plate and output in the antenna. It was impossible to adjust the coupling so as to obtain maximum output at the shorter wavelengths.

TRANSMISSION AND RECEPTION TESTS.

Signals from this set, which supplied 5 amperes effective current to an antenna approximately 50 feet high in Washington, were copied at a distance of 100 miles by using an antenna 60 feet high, with an audibility of 10,000, using an autodyne receiving circuit with a two-step audio-frequency amplifier. Signals from this set, working under the same conditions, were received through heavy interference by using a 6-foot coil aerial and a similar detector and amplifier, at a distance of 225 miles.

It has been found in other tests that waves modulated in this fashion cannot be received with high efficiency with a simple non-oscillating detector. The voltages induced in a receiving antenna by a logarithmically modulated wave will give a response on the output side of the detector greater than that induced by a sinusoidally modulated wave train radiated from antennas in which the effective antenna current is the same, provided always that we confine our attention to short wavelengths. The truth of this statement has been proven experimentally by direct comparison of two such transmitters. It is beyond the scope of the present paper to discuss quantitatively the effects of sinusoidally and logarithmically modulated wave trains upon receiving antenna with rectifier and phones. However, a possible reason for such a behavior is suggested by the accompanying diagram, Fig. 2, upon which are plotted to the same scale the envelopes of spark and sinusoidally modulated wave trains emitted by two transmitters operating at 500 cycles and supplying the same antenna with the same effective antenna current. Altho the logarithmically modulated wave train persists only about one-twelfth as long as the sinusoidally modulated wave train, yet it rises to a peak value over thirteen times as great. In order to give some idea of

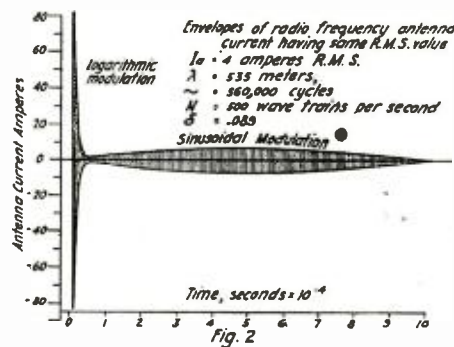

Comparison of Wave Trains Emitted by a Spark and a V.T. Transmitter.

vide a reactive shunt for the oscillatory circuit; second, the approximate linear relation between power output, resistance, and capacity. Consider any short portion of the wave train when the amplitude of the supply voltage may be considered constant so far as the radio-frequency oscillations are concerned. It has been shown¹ that the output power is given for any tube by

$$P = \frac{1}{R} \frac{L}{2C} f(P)$$

where R , L and C are the resistance, inductance and capacity of the antenna and f is a function which depends upon the characteristics of the tube and upon the plate and grid coupling. Over a certain range of operation the function f , which involves the oscillating grid voltage as dependent upon the antenna current and coupling, is found to be a direct linear function. Then the output power varies inversely with the antenna capacity and with the antenna resistance. Assuming constant L , since a change in L involves a change in the function f , it is evident that if C is made small, as is the case at short wavelengths, R must be increased, in order to obtain maximum output. It may be impossible to obtain maximum output from a tube in a given antenna of low re-

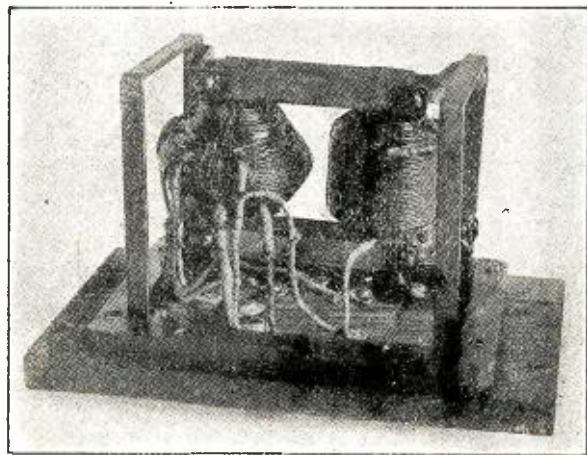

Fig. 5. This is the Filament Circuit Transformer, the Compensating Winding of Which is Composed of 100 Turns No. 16 d.c.c. Wire With a Tap Every 12 Turns From 30 to 100.

¹Hull, L. M. Determination of output characteristics of electron-tube generators. Bureau Standards Sci. Rep. 25.

The Audion—Its Action and Some Recent Applications

By LEE De FOREST, Ph. D., Sc. D.
Part 2

A historical paper of unusual interest to the Radio Fraternity

It was in the summer of 1912, when at work on the problem of audion amplifiers in cascade arrangements for telephone repeaters, that I discovered that if the input or grid circuit was inductively coupled with the output or plate inductance, the audion became a generator of continuous alternating currents, originally made evident by a shrill tone in the telephone receiver. A typical regenerative circuit is illustrated in Fig. 11. The explanation of the operation is simple. An initial impulse in the plate circuit, however produced, induces a similar one in the grid circuit, which, if of proper polarity, will impress on the grid a sudden change in potential which may in its turn produce an impulse in the plate current in the opposite direction to the original disturbance. This reaction then becomes self-sustaining, provided the resistance and hysteresis losses in the two circuits are not too great; and the amplitude of the oscillating current thus set up goes on increasing, taking energy supply from the B battery, until the losses in the circuits equal the increment of energy drawn from the battery. Whereafter an alternating current of perfectly constant amplitude and wave form is maintained. The frequency of this alternating current depends on the constants of the circuit, the inductance and capacity in the input or output circuits. But under certain conditions it depends to some extent also on the resistance in the grid leak, if this be used, and sometimes, but not usually, on the temperature of the filament and the B voltage.

A few months after this type of circuit was first used for the production of alternating currents of audible frequency I first demonstrated the fact that weak high-frequency currents could equally well be generated, simply by substituting radio-frequency coils for the original iron-cored coils, and small variable air condensers for the large telephone condensers of the original experiment. And quite naturally, also, since I was at the time engaged chiefly in work on undamped wave radio transmission, this generation of radio frequency waves was first demonstrated in receiving hetero-

dyne, or more exactly autodyne, signals. The circuit used at this early date, April, 1913, which was almost identical with that in Fig. 11—Fig. 12, shows the usual antenna receiving circuit, the usual secondary circuit connected across the grid and filament of the audion, but with another coil similar to the secondary in series with the telephone receiver, which in this case was abridged by a small condenser.

AN ACCIDENTAL DISCOVERY

In the fall of that year my assistant, Mr. Longwood, and I discovered, largely by accident, that if the secondary receiving circuit be connected across the grid and plate, instead of as customary between the grid and filament of an audion, the circuit became a persistent oscillator, very simple and effective as a receiver of undamped wave signals. On account of the great sensitiveness of this combination the name "ultraudion" was applied to it. Countless modifications and adaptations of these two general types of oscillating audion circuits have been developed by radio men here and abroad. For their simplicity, the ease with which all the advantages of the beautiful heterodyne principle of Prof. Fessenden and Vreeland can be realized, the clarity of note and range of pitch which the receiving operator can instantly command—coupled with a degree of sensitiveness of a different order from that of any other type of detector—these advan-

tages very quickly relegated to the scrap-heap the ticker and tone-wheel; and at once placed the transmission by undamped waves upon an altogether different level from that of the older spark method.

But the audion in an oscillating or an almost oscillating, or unstable, condition is also of great utility in detecting damped wave signals, or even radio telephone currents. If the two circuits, input and output, are so separated as to interact less energetically the oscillations become weaker and finally cease to be generated. When in this condition a very feeble impulse, if properly attuned, can set the system into vibration. The resulting response develops an energy almost unrelated to the cause. Enormous magnifications are thus possible with a single audion, and spark signals have thus been received over the greatest span which it will ever be possible to reach on this earth—half way around the globe.

In receiving undamped wave signals, when the local oscillating receiver circuit is slightly out of tune with the incoming waves, the received currents on reaching the grid are amplified, first by the ordinary processes of the audion, and then combine with the local oscillations to produce "beat" notes, of audio-frequency which beat note currents are themselves amplified by the audion, before delivery to the telephone receiver. So sensitive is the pitch of this beat note to the slightest change of capacity or

inductance in the circuit (when very high frequencies are employed) that in properly designed circuits a change of capacity of one-thousandth part of the electrostatic unit can be detected. A change of capacity which is caused by substituting coal gas for air in a condenser can thus be easily measured. Similarly can be demonstrated slight changes in resistance with temperature of conductors, the conductivity of flames, the permeability of liquids, etc. Very recently Prof. Blondel has utilized the audion in a balanced bridge method for measuring excessively slight differences in static potentials.

The uniform generation of electrical oscillations in a circuit by means of an audion

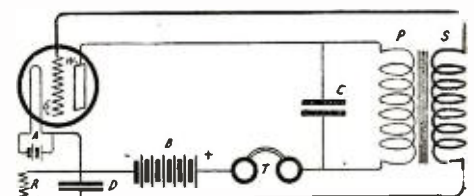

Fig. 11
Another Fundamental "Feed Back" Circuit Employed in Developing the Audion.

is one of the most striking and fascinating of its applications. If these are of radio-frequency there is no sensible manifestation

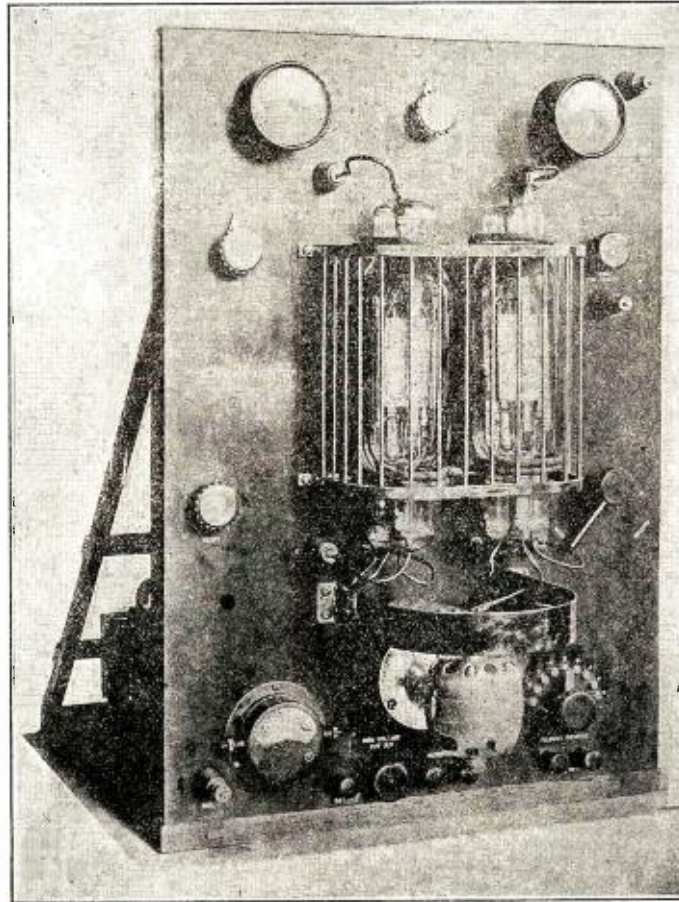

Fig. 15. Typical Oscillon Transmitter Which Utilizes Two Half Kilowatt Vacuum Tubes.

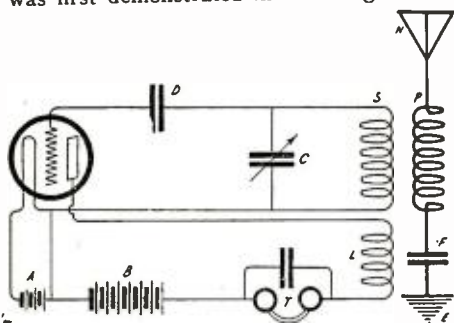

Fig. 12
An Early Autodyne Circuit Used by Dr. DeForest.

of their presence, but if of audio-frequency the telephone receiver or "loud speaker" reproducer may be made to give forth sounds from the highest pitch or volume to the softest and most soothing tones. Such wide range and variety of tone can be produced from suitably designed singing circuits that a few years ago I prophesied that

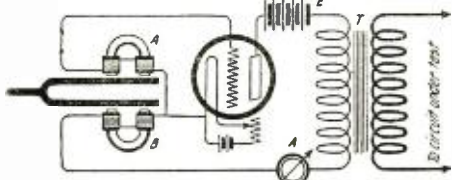

Fig. 13
In This Case a Tuning Fork is Driven by Electro-Magnets.

at some future time a musical instrument, involving audions instead of strings or pipes, and batteries in place of air, would be created by the musicians' skill.

DRIVING A TUNING FORK

But lower frequencies, even to one oscillation per second, can be obtained from the audion. Pulsations suitable for submarine cable signalling, or for chronograph and time-pendulum work, can be had of remarkable constancy and reliability, free from all difficulties of speed regulation of motors, or of any moving parts. Or a combination of mechanical time-factors, and the electrical properties of the audion can be advantageously employed. For example, a tuning fork may be driven by electro-magnets, one connected in the grid circuit, the other in a plate circuit, as shown in Fig. 13.

The movement of the grid prong here induces an e. m. f. on the grid, which in turn controls the plate current thru the other coil acting upon the other prong of the fork, thus sustaining its motion. If the two coils here shown are also closely coupled inductive reaction, or regeneration, is added to the mechanical, and very powerful vibrations may be thus set up. Various modifications of this principle will suggest themselves to physicists, who desire sparkless generation of low frequencies of great constancy. Tuned relays, highly selective to definite frequencies, and where it is desirable to reduce the damping to zero or nearly zero, can thus be constructed. The above arrangement is due to Messrs. Eccles and Jordan.

A modification of this method of linking the audion with mechanical motion is the magnetic pendulum, actuated by the plate currents through electro-magnets and inducing in another coil properly tuned impulses which, if conveyed to the grid, control thru almost sinusoidal currents the successive pulls upon the pendulum (Fig. 14). When a second system identical with the first, but located at right angles thereto, is employed, the pendulum will be set into conical vibration, circular or elliptical as desired, and a revolving electric field will be produced, which can also be made to drive an armature or magnetized wheel at a certain definite speed.

There seems to be, in fact, no limit to the number of applications to which this three-electrode vacuum tube can be applied as a tool in the hands of the experimental physicist. Of especial value is the fact that it renders easily available

devices having *negative electrical resistance*, as in the four-electrode device of Dr. Hull (styled the "dynatron")—or its equivalent in some mechanical form. For one fundamental property of the audion is that an electrical influence in one circuit may, thru the grid, be made to produce effects in another circuit without appreciable reaction. For the energy absorbed by the control electrode may be considered negligible—frequently less than that required in moving a galvanometer needle.

THE MICROSCOPE OF RADIO

Then, and probably the most promising field of all, the arrangement of audions in cascade as amplifiers, of pulsating currents of any form or frequency—opens to the eye what the microscope has given to the eye—new regions of research in numerous and diversified fields from physiology, for heart beats and breath sounds—to chemistry, where some even predict that we shall some day hear "the collision of individual atoms with one another." During the war British army engineers used as many as nineteen audion bulbs in cascade circuit, amplifying preferably the radio instead of the audion frequency currents. With such a series it is possible to detect with certainty alternating currents of one-ten-thousandth-millionth of a volt on the input grid—involving magnifications of the order of twenty thousand times. It is an everyday occurrence now to receive radio messages from Norway or Honolulu, on a closed-loop antenna one metre in diameter, using three or more audion amplifiers in cascade between this antenna and the detector, and sometimes a similar multi-stage amplifier for audio frequencies, between the detector and the telephone receiver.

Principles which, tho long understood were impossible of application to radio signalling, have been made realizable by the audion amplifier, and the scope and value of the new art immeasurably increased thereby. For example, the use of underground receiving antenna, the direction-finder, or radio-compass loop, the elimination of static interference by either of the above, or other methods—all such were compelled to await for their successful application the introduction of the grid electrode. Starting with the small bulb used in 1912-13 as a telephone amplifier and generator of minute electric oscillations for heterodyning purposes, I began the construction of larger sizes to be used in undamped wave transmission. At first spherical bulbs, three or four inches in diameter, and taking 50 watts of plate input energy,

were considered large. Such rapid progress was made in improvement of design and construction of these so-called "power tubes," notably by the engineers of the Western Electric Co., that by autumn of 1915 a bank of several hundred tubes, their input and output electrodes connected in parallel, were installed at the Arlington wireless station. By a pyramidal circuit arrangement, whereby one oscillion tube con-

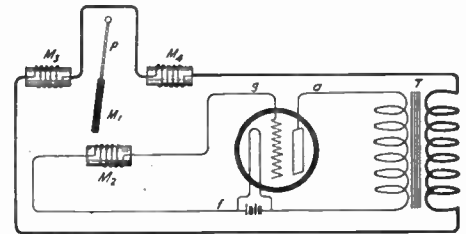

Fig. 14
Linking the Audion With Mechanical Motion By Means of a Magnetic Pendulum.

trolled a group in parallel, these in turn controlling larger groups of oscillion tubes, some twelve kilowatts of undamped wave energy was delivered to the great antenna, all perfectly controlled or modulated by an ordinary telephone microphone. By this arrangement the voice was transmitted that year as far as Honolulu and Paris, thus fulfilling predictions made in 1909 to a very skeptical world.

THE ALEXANDERSON MAGNETIC AMPLIFIER

In these Arlington tests the entire system was one of three-electrode tubes—for power generator, for current modulation thereof at the transmitter, and for detector and amplifier at the receiver. More recently Alexanderson, using his powerful high frequency alternator at New Brunswick, has controlled 80 kilowatts of antenna energy by means of his magnetic amplifier. This ingenious development of a Fessenden device was in turn controlled by a bank of large audion amplifier tubes, nicknamed "pliotrons," whereby the original microphone currents were sufficiently amplified to control the saturation currents necessary for the magnetic controlling device.

There are today grave differences of opinion among radio engineers as to what type of high-power radio transmitter will prove the key to the future—the high-frequency alternator, the Poulsen arc, or the oscillion. In my own opinion, the long-distance transmission art will shortly depart from true radiation methods; and the a. c.

generator, of comparatively low frequency, will be widely used for such subterranean, or submarine transmission, leaving for ship communication only the survival of radio transmission, as it is known today. Such being the case, we will then have little use for radio transmitters of more than 20 to 50 kilowatts. For such transmitters I foresee the early use of a few large oscillion tubes, of, say, 2 kw. capacity each. Already we are making tubes capable of handling one and two kilowatts, using tungsten filaments and grids, and large anode plates of tungsten or molybdenum. The efficiency with which several such tubes can operate in parallel, the ease with which an amplified voice current, acting upon their grids in parallel, can control their combined output, make such a sys-

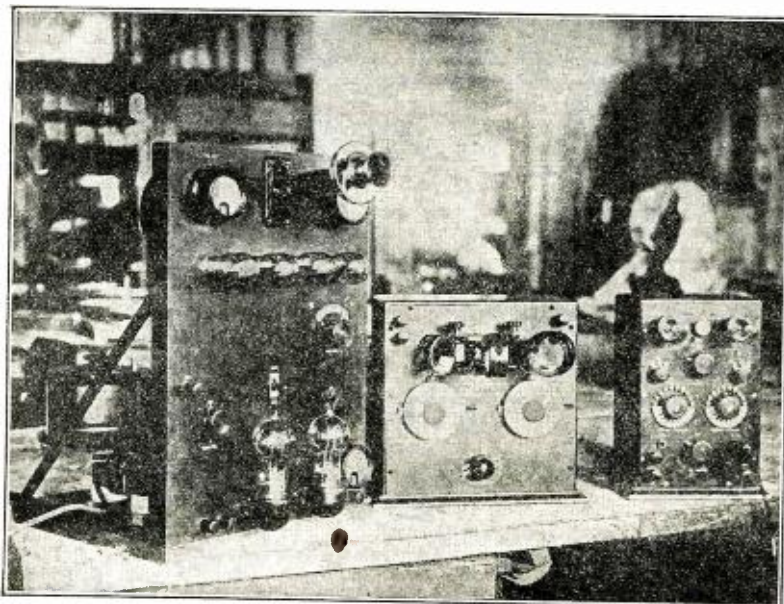

Fig. 18. A Radiophone Unit Which Operates Directly From a 110-Volt A. C. Supply and Which Furnishes Its Own Plate Potential. The Set Consumes 50 Watts, Places .75 Ampere in an Average Antenna and Operates Up to 50 Miles.

tem almost ideal as a radio telephone transmitter. A typical oscillation transmitter utilizing two half-kilowatt tubes is illustrated in Fig. 15. The schematic circuit diagram for such a transmitter is shown in Fig. 16.

LARGE TUBE CONSTRUCTION

In the construction of these large tubes a thousand details must be scrupulously observed—in addition to the calculated physical dimensions of the elements, the choice of materials, the method of seal, the preliminary treatment of the metals, their welding, the screening of the glass from bombardment, the various steps in the process of exhaustion—on careful observance of all these alone depends success in the manufacture of a high-power tube. A reasonably long life, of 500 to 1000 hours, is afforded by the tungsten filament, pure or alloyed with thorium; but this is by no means an ideal source of electrons. As such, tungsten, while preferable, is highly inefficient. By coating fine platinum ribbon with oxides of calcium, strontium, etc., or of the rare earths, similar to those in the Nernst glowler, far higher emission efficiency is had, at lower temperatures, with resultant increase in

But such oxide-coated filaments are fragile and very frequently damaged during exhaust. Moreover, many types of coating lose their power of electron emission after a time. This method seems at best an imperfect makeshift. What the audion art awaits is a ribbon filament of some new, well-conducting alloy, wire drawn or rolled of non-crystalline structure, emitting floods of electrons at a heat lower than visibility. Forward awaits the metallurgist who first produces such a filament. For to day the audion is being produced in quantities which in pre-war days would have been considered fantastic exaggeration. During the last months of the war the world production of such bulbs had attained the incredible rate of 1,000,000 per annum. And now the demand in America alone, chiefly from radio amateurs and experimenters, is at the rate of 5,000 per month, and constantly growing. And most of these latter are used singly or in two-step amplifier arrangements. During the war, however, thousands of amplifier and transmitter instruments, each requiring 3 to 9 bulbs, were in use—in earth telegraphy, in submarine listening, in telegraphy by ultra-violet or infra-red rays, in gun-spotting, airplane detection, etc., in addition to those required for ordinary radio telegraphy and telephony.

The necessary conditions for an audion to function as a generator of alternating currents have been the subject of exhaustive study by many investigators, notably by Hazeltine, Ballantine, and Mills in this country; Vallauri and Eccles abroad. There are today countless circuit arrangements whereby the audion may be caused to generate such currents; but in all of the practically useful ones, where considerable power is required, the inductive linking of the grid and plate circuits, analogous to that first used in 1912, is in one form or another employed. One of the simplest forms of such circuit is shown in Fig. 17. If there is no time lag in the electronic stream behind the pulsations of grid voltage, as is the case in a highly exhausted tube (up to frequencies of ten million per second), then the

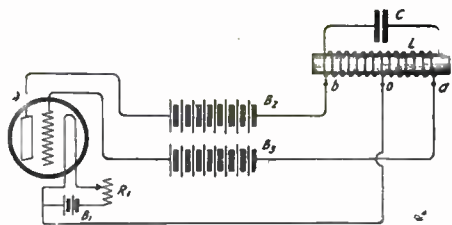
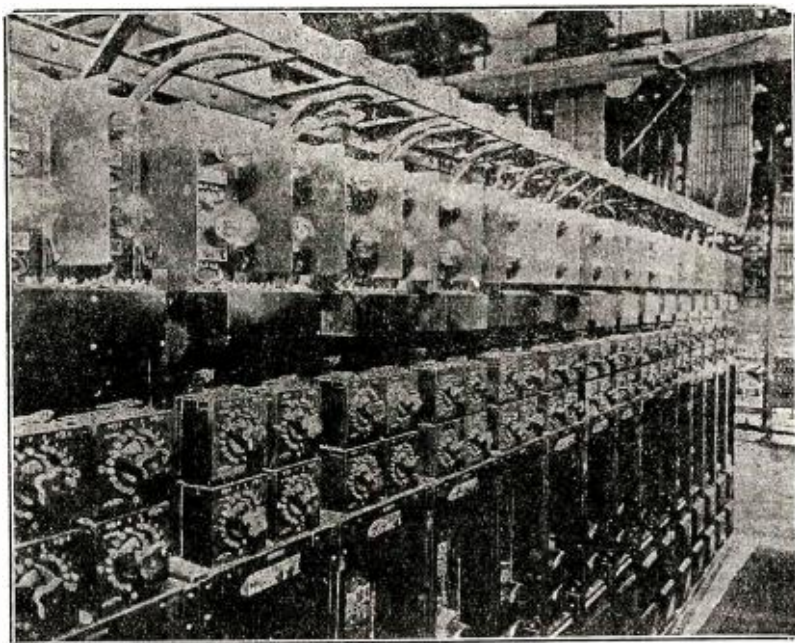

Fig. 17
Simple Form of Inductive Linking of the Grid and Plate Circuits.

above arrangement becomes an alternating current source whose frequency depends upon the natural frequency in the LC circuit. The period of this oscillation is very nearly $2\pi\sqrt{LC}$ if the resistance, r , of the external plate circuit is small, the resistance, or reactance, p , of the plate-filament gap is great, and provided the mutual induction, m , between the inductances in the grid-filament and plate-filament circuits is just suf-



Vivid Illustration of the Completeness With Which the American Telegraph and Telephone Co. Have Applied the Audion Repeater to the Commercial Long-Distance Telephone Service of the United States.

ficient to maintain the oscillations.

$$\text{If, then, } m > k \left(\frac{L}{p} + r.C \right)$$

this oscillating condition is realized; and K in this formula can be defined as the "amplification factor."

THE USE OF A.C. FOR PLATE SUPPLY

One of the latest developments in the oscillation transmitter is the application of al-

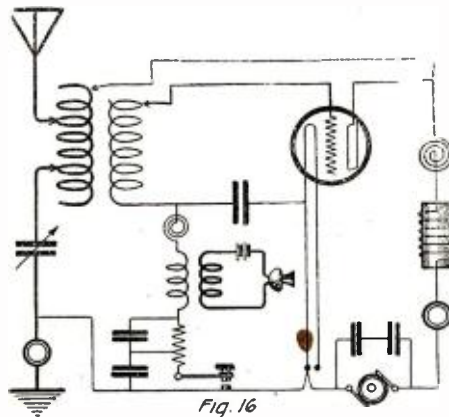

Fig. 16
Schematic Circuit Diagram of the Oscillation Transmitter Panel Shown in Fig. 15.

ternating current for the plate voltage supply. Sixty-cycle current is taken from a lamp socket, stepped up to 500 or 10,000 volts (according to the size of the transmitter)—the two halves of the cycle rectified through two-electrode vacuum valves, this rectified current stored in a suitable condenser, smoothed out by an appropriate "filter" circuit, and finally delivered as high-voltage direct current to the plate-filament circuit of three-electrode oscillator tubes. The filaments of both rectifiers and oscillators are lighted from the low-voltage windings on the one transformer. Such an arrangement does away with the motor generator converter, and even with 60-cycle supply gives surprisingly clear voice transmission. A small set of this type employing two rectifier and four small oscillating audions in multiple is shown in Fig. 18. With this small unit, consuming 50 watts and putting three-quarters of an ampere in an average antenna, one has recently telephoned fifty miles.

The developments by the engineering staff of the Western Electric Company of the audion amplifier as a telephone repeater, since my first demonstration to them of its possibilities in that field, are beyond all praise. The zeal and rare understanding of the elements of the problem with which this staff of trained men develop the amplifier and applied it to the long-sought transcontinental telephone line stand unique in the annals of brilliant achievement in electrical engineering.

The time was ripe. Had the audion amplifier been presented at a much earlier date it is unlikely it would have then met the warm welcome which twenty years of futile search for the telephone repeater had earned for it. It was the irony of inventive fate that this revolutionary telephone device was to come, not from those whose efforts had for years spun in the old rut of the receiver-microphone "siam-eesed" together, but from an art younger than telephony, from a device conceived for a quite different application—a wireless telegraph detector.

"From small beginnings the transcontinental line has been evolved. One element after another came. First the telephone receiver of Bell; then the Berliner—Edison microphone; then adequate line construction; the Pupin coil to prevent voice distortion—and finally the one missing link, the Audion Amplifier. Try to imagine one of the electronic carriers of the voice currents in this amplifier, and contrast it with a carbon granule of a microphone transmitter of the early telephone relays. Compare a soap bubble with a load of coal, and you will have some relative idea of the distinction between the delicacy and elegance of the audion and that of the old microphonic relay." A more revolutionary step was never taken in the history of electrical engineering.

A repeater suitable for our present wire cable. This actually means that the repeater must be capable of delivering 256 times as much energy as it receives; that is, possess a telephone efficiency of some 26,000 per cent, and this without appreciable distortion of the most intricate of voice current waves, involving all frequencies from 100 to 3,000 per second. Any repeater or amplifier which

(Continued on page 333)

The Kleinschmidt Automatic Transmitter

By LIEUT. W. KLAUS, U. S. N.

YOU have probably all listened in at one time or another and heard the New Brunswick or Annapolis Stations sending high speed and wondered as to what the apparatus sending this stuff looked like. Although possibly you thought the apparatus must be very complex, it is quite simple and for the benefit of those men who may at some future time be ship-mates with this type of apparatus the following description and explanation is herewith given.

The high speed system comprises a perforator for punching paper tape, and a reproducer or transmitter for using this tape to send the dots and dashes into the relay key circuit. It is obvious that this tape can be perforated at any speed within certain limits, accumulated, and used in the Automatic Transmitter at a much higher speed, thereby saving much valuable time on the transmitting wave length in the ether. Also, several perforators can be operated simultaneously and the tapes fed into the one transmitter sending at a high rate of speed thereby handling a larger amount of traffic in twenty-four hours than ordinarily could be handled by hand sending. Another use is for sending words twice at a slow speed to get the traffic through static. The tapes can be marked and saved and if it is necessary to repeat, the tape can be used over again, eliminating that long, tedious hand sending.

Although it is claimed that the automatic transmitter can work up to 250 words per minute trouble is experienced in the control lines and in the station relays at this speed. So far successful results have been obtained up to 125 words per minute.

OPERATION OF THE KLEINSCHMIDT PERFORATOR.

The construction of the Kleinschmidt perforator while seemingly complex at first glance is in reality very simple. The keyboard is of the standard typewriter type with the addition of the "break" sign, "AS," "UD," "AR" and a "combination" key which when held down will run the letters together for various other radio signs.

The action in general is as follows: The tape passes in front of a set of perforating pins in a die. There are three rows of pins, one row above the other. The different letters of the alphabet are perforated into the tape in the form of different combinations of holes above and below the center line of the tape. The middle row of pins perforate the feeding holes into the center line of the tape.

The various combinations of the perforating pins are set by the different keys of the keyboard. When a key is depressed after lifting up a set of fingers behind the perforating pins for the proper combination, it makes an electrical contact which causes a solenoid to draw over a hammer behind the die, thereby pushing the combination of pins through the tape for that certain letter. There is a feeder ratchet wheel over which the tape runs and the tape moves forward ready for the next letter.

The diagrams are extremely elementary in form, and while not showing the exact mechanical arrangement of the perforator, will illustrate the principle of operation.

The single key shown in Fig. 1 is for the letter E. The tape when perforated for the letter E will have one hole above and one hole below the feeder perforations, as in Fig. 1.

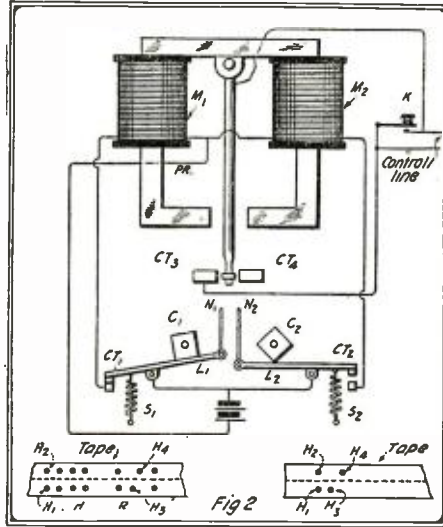

This Diagram Illustrates the Manner in Which the Polarized Relay Performs the Transmitting Operation Through the Medium of Perforated Tape Representing Letters.

The explanation of the action of the Transmitter will show how these two dots combine to send the one dot, along the control wire for the letter "E."

There is a pin "X" fitting up behind each of the perforating pins of the upper row and a pin "Y" fitting up behind each of the perforating pins of the lower row. Each pin is connected to a lever L with projections running across under the typewriter key levers, like A and B on it. The keyboard keys have the proper projections C & D on them to set the correct combination of perforating pins "X" and "Y," before the electrical contact C₁ is made which energizes the solenoid S bringing the hammer H over and pushing the pins through the tape. The row of feeding perforating pins are pushed through the tape every time a letter is punched or when the spacing bar is pressed. The tape is fed through the die by a ratchet wheel which has little projecting pins which fit into the feeding perforations or center row of holes on the tape. This ratchet wheel is operated by the hammer H. There is an attachment on it which allows the ratchet wheel to turn just the proper amount for feeding the tape the correct length for each letter. The "combination" key also operates this ratchet wheel to feed the tape a less amount than ordinary, so the next letter will be run close to the preceding one as in making the parenthesis sign from KK.

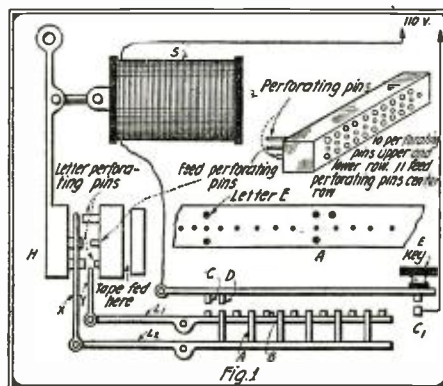

Elementary Diagram Illustrating the Principle of Operation of One Key, in This Case the Letter "E".

The Solenoid is wound in two sections and can be connected for 110 or 220 volts. When the perforator is adjusted perfectly a speed in perforating almost equal to that on a typewriter can be attained. The tape is 1/2 inch wide and is supplied on rolls eight inches in diameter containing about 1000 feet. When the tape comes from the perforator it is wound upon flat spools by a spring motor and the spools set in a stand for running through the transmitter.

OPERATION OF THE AUTOMATIC TRANSMITTER.

The automatic transmitter is a motor driven with a speed regulator. There are two types now in general use; the Wheatstone and the Kleinschmidt. The Wheatstone has a field resistance regulator while the Kleinschmidt has a friction disc clutch speed regulator, the motor revolving at a continuous speed. These transmitters work on slightly different principles but the resulting operations are the same. The Kleinschmidt uses a polarized relay to get the dots and dashes from the combination of perforations in the tape, while the Wheatstone uses a mechanical arrangement of springs and levers allowing a set of contracts to make the dots and dashes from the combinations of dots in the tape.

We will describe the Kleinschmidt as that type is the one most used in the Naval service. Referring to Fig. 2, PR represents a polarized relay; C₁ & C₂ are cams worked on the same shaft set 1/4 turn from each other so that just lever L₁ is allowed to be pulled up by spring S₁ and then L₂ is allowed to be pulled up by spring S₂. The tape runs over a track above the steel needles N₁ & N₂ by a toothed wheel fitting into the center row of holes on the tape. Now for the action of making the dots and dashes. If a blank piece of tape is run through the transmitter, the levers L₁ & L₂ go up and down L₂ following L₁ but contacts CT₁ and CT₂ do not close because they are set at such a distance that N₁ & N₂ would have to go up a distance higher than the blank tape allows. Springs S₁ & S₂ are not strong enough to force the needles N₁ & N₂ through the tough oiled paper tape. If a perforated piece of tape with all dots like the letter H is fed through the transmitter needle L₁ is allowed to go up through a perforation in the left side of the tape hole indicated by H₁ and contact CT₁ closes, local current is sent through polarized relay coil N₁ and contact CT₃ closes, which is the same action on the control wire as if Key K was depressed. A fraction of a second later cam C₂ allows needle N₂ to go up and as perforation H₂ in tape is above it lever L₂ is pulled up by spring S₂ allowing contact CT₂ to make energizing relay coil N₂ breaking contact CT₃. Circuit on control wire is now broken which is the same as if key was allowed to come up. The cams are so timed that the interval of "make" of the contact CT₃ is equal to a dot. In the case of a dash, needle N₁ goes up through perforation H₁ allowing CT₁ to close, which energizes M₁ making contact CT₃. Needle N₂ does not go up all the way until perforation H₂ in the tape comes along which is equal in time to a proper dash. Therefore CT₂ is not broken until this perforation H₂ comes over N₂ allowing CT₂ to close, which energizes M₂ pulling armature of polarized key relay PR over, breaking CT₂, which is same effect as letting key K up. CT₃ is held in "Make" position long enough to cause a dash to be sent over control wire. D. N. C. Bulletin.

Some Unique Radio Appliances*

Interesting Additions to the Radio Game Designed to Popularize Concentrated Inductances in a Variety of Ways

It is a pleasure to be able to present to our readers these illustrations of radio accessories which are of a rather distinctly novel construction and application suggestive of many uses.

In our photographs we show two methods in which concentrated coils may be readily adapted to any standard variable condenser by means of the universal devices which are shown separately in the lower part of the picture.

The adapter in the lower left hand corner is so constructed that it may be fitted to the binding posts of any condenser and enables the experimenter to set up various oscillating circuits using, of course, proper value of inductance or capacity. Thus he has any inductance-to-capacity ratio requirement which may arise during laboratory or other experiments. Not only is this useful in laboratory, but may also find permanent use by operators at commercial stations.

This same appliance is so designed that it may be connected in shunt with the capacity and inductance used, and at the same time is furnished with binding posts so that a meter, resistance or other device may be connected in series by simply opening the metal strap which connects the two binding posts on either side of the attachment.

A suggested use, for instance, would be for a long wave work which requires two of these units, two condensers of suitable capacity, two long wave concentrated inductances; and the combined instruments properly connected to the regular detecting circuit. It does not require much imagination to see that any sort of damp or undamp hook-up in modern use may be tested out, particularly those involved in C.W. and radiophone reception. Another excellent use for the device would be for standard wavemeter work.

The unit shown at the extreme lower right hand corner is a universal swivel connector making possible various coupling between two circuits without changing the position of the rest of the apparatus in use; in other words, while the condenser remains stationary, the inductance coil may be revolved at any desired angle, thus offering *minute* coupling regulation.

The concentrated inductance shown in the center of our illustration, is fitted with positive contact makers which may be plugged in and out of the receptor in an easy and *shockless* manner without in the least disturbing any other part of the circuit. As for the small square unit shown directly beneath the coil, this is a third device designed for panel or table use. It may be readily secured to a panel and forms the receptor unit for the coils mentioned here.

Perhaps some of you may wonder how this swivel connection is accomplished, that is to say, how the two separate parts may

be operated and at the same time insure certain and proper contact. In this action it may be said that positive contact is accomplished by means of circular rings embedded in the bakelite of the upper part, and upon which two brushes arranged at

Owing to the shortness of leads, the decrement of any circuit will be much less than would otherwise obtain with the usual hurried and temporary hook-ups, thereby increasing the ever-elusive efficiency of a circuit to maximum—a most desirable factor.

Surely we have arrived upon the era of *minutely* refined development of radio apparatus. It is to be hoped that we shall see other manufacturers come forth with similar ideal appliances.

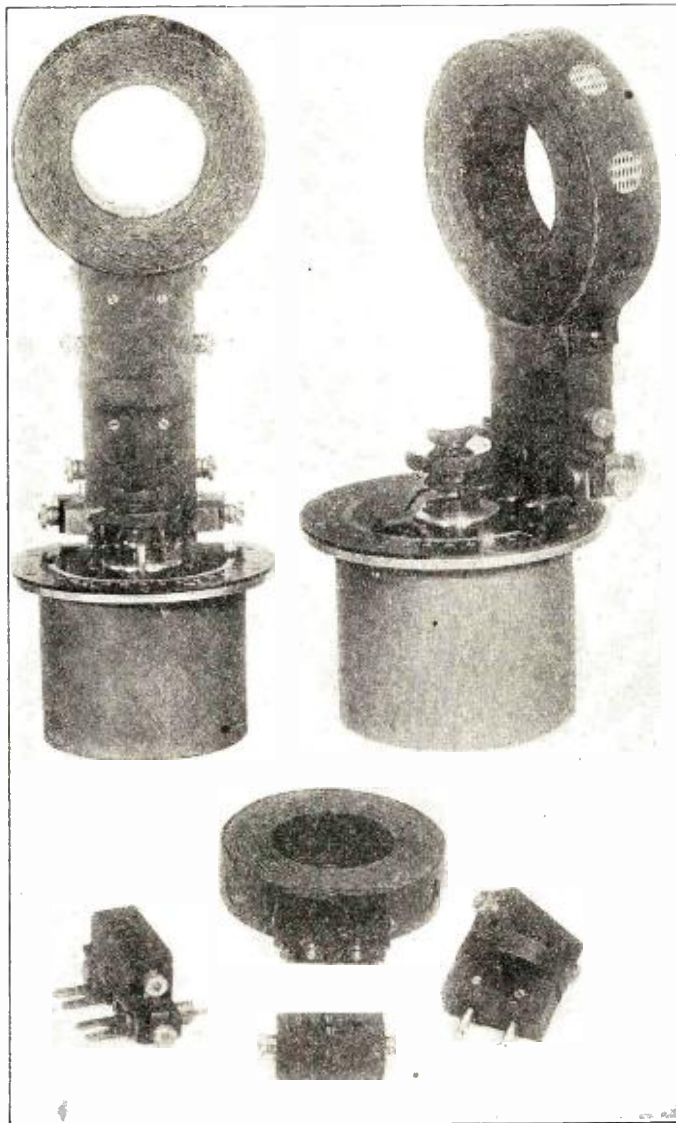

Novel Appliances Making Possible All Manner of Radio Hook-Ups.

the proper distance of the lower part are made to press firmly upon the rings by the use of a firm spring action.

These units are made of molded bakelite and particularly designed for strength, perfect insulation and neat appearance.

Features.

Some features which will probably make these appliances very popular in present day amateur experimental and research work may be briefly described thusly:

Ease of applying to any variable condenser.

Readily interchangeable without interfering with the plans of other parts of the circuits.

Positive and permanent contact under any position.

Any suggestive circuit found in radio publications can be readily *made up*.

Readily adaptable to modern forms of the popular concentrated inductances.

British Radio Plans

It is understood that British officials have devised a far-reaching scheme of considerable importance for the purpose of linking the whole British Empire. The original report reached this country some time ago and was given great publicity in the press of the United States. The substance of the plan follows:

A British empire chain of radio stations, free from private monopoly and possible alien interference, is aimed at by the Imperial Wireless Telegraphy committee, headed by Sir Henry Norman, according to reports from Ottawa, Canada.

The report of the committee states that by adoption of a plan which it puts forward, a series of connecting stations can be established and maintained at an initial annual cost of not more than \$500,000. This sum, it is said, would secure a system vital in its strategic and commercial potentialities.

The main recommendations are: That a system of imperial radio communication be established connecting the communities of the empire by geographical steps of about 2,000 miles each.

That the transmission system employed by that of the generation of radio-telegraphic energy by thermionic valves, or vacuum tubes.

That the service of communication between Leafeld and Cairo by Poulsen arcs, shortly to be put in operation by the post office, be the first link in the chain of communication with the British communities in South Africa, and that this communication be continued by a valve station at Windhuk to a valve station to complete the connection with the Union of South Africa.

That for communication with India, the far East and Australasia valve stations be erected in England, near Cairo, at Poona (or other Indian station), Singapore, Hongkong and Perth or Port Darwin.

That similar communication be established with Canada, subject to the decision of the imperial and Canadian Govt.

That the system be governed by a radio commission of about four members, and that its execution be intrusted to an engineering department of the post office and the corresponding Dominion and Indian authorities.

The committee asserts that an imperial radio system established in this manner would afford reliable, expeditious and economic communication for commercial, social and press purposes.

*Illustrations by courtesy of Patent Electric Co., Inc.

A New Continuous Wave Type Transmitter*

An Example of a Modern Three-tube Unit

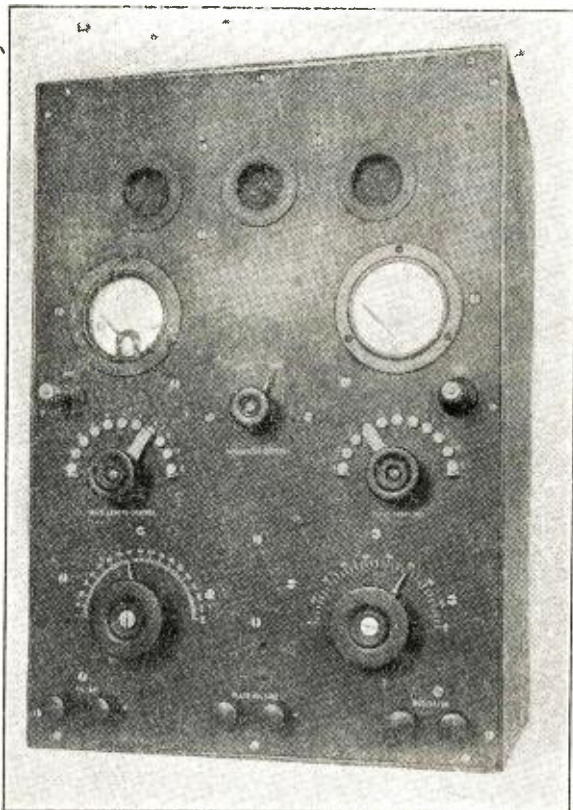

What Do You Think of This Unit, Fellows? Looks Formidable Enough to Push Thru the Ether Some Miles, What?

grid and plate modulation is the result of extensive and thorough comparative tests, which proved that this modulation is as good as the existing methods of modulation which employ separate modulating tubes. This is a great advancement since with the same number of tubes it is possible to radiate more energy than with other similar transmitters; the quality of the modulated wave remaining the same. The grid potential may be varied thru a variable resistance which is connected to the negative side of the filament and generator. This is desirable in order to control the proper grid potential for *distortionless modulation*. The control knob between the meters marked modulator control accomplishes this result. With this means

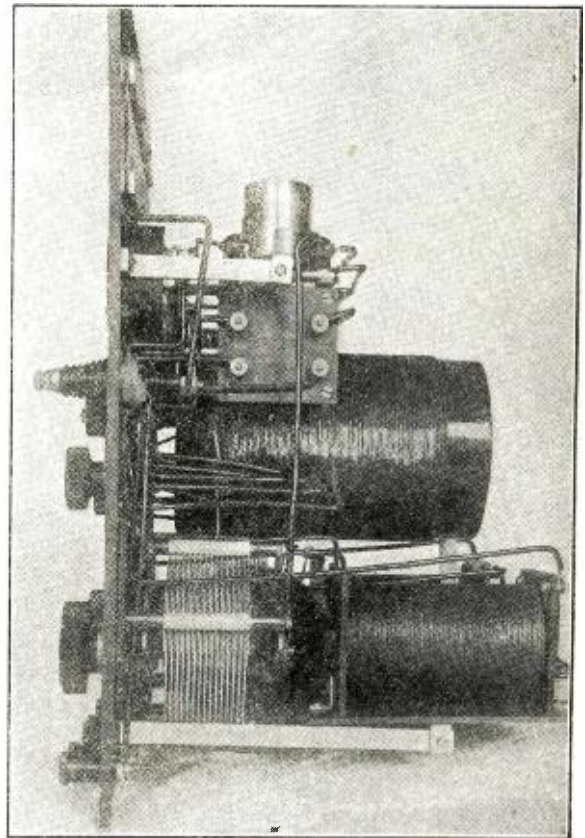

Side View of the V.T. Set Described Here With Cover Removed. The Filter System is Seen at the Extreme Lower Right Hand Corner.

LOW power continuous wave type radio transmitters have made rapid advances during the last few years, this being due primarily to the successful developments of the three electrode, vacuum tube and its associated circuits for the generation of sustained high-frequency alternating currents. In addition to the development of the tube itself, great strides have been made in methods of efficiently modulating these radio frequency currents. Due to these two recent developments, the present low power radio-telephone transmitter was the outcome.

In connection with the development of this transmitter, shown in our present illustrations, the question of cost and compactness had to be borne in mind, in order that the instrument might be sold at a reasonable price.

The "Saco" type CWT-1 employs three five watt tubes all acting as oscillators, modulation being accomplished by controlling both the grid and plate potentials simultaneously. With this method it becomes possible to modulate the greatest portion of the emitted radio frequency current, thus permitting greater telephone transmission range. This method of

it therefore becomes possible to control the quality of the modulated wave.

The milli-ammeter is in the plate circuit of the three tubes and its purpose is to denote the *amplitude of the modulated wave*.

The oscillating system is of the single circuit type consisting of a single inductance and is used for both tuning the antenna circuit and also grid and plate coupling. Coupling, on the other hand, is accomplished by controlling the number of turns of the inductance coil, this being performed by a variable control switch in front of the panel. Incidentally, this variation of coupling is of extreme importance since there exists a *definite coupling* for every wavelength. Additional coupling ad-

justments are accomplished by means of a variable grid condenser and antenna tuning condenser.

The *amplitude of the radiated radio frequency current* is denoted by a Weston Thermo-ammeter placed in the ground circuit. The binding posts marked "Modulator" which are connected to the primary of a modulating transformer may be led to a telephone microphone in series with two dry cells when the set is to be used as a radiophone transmitter, or they may be connected to a high frequency buzzer with its key and batteries, in place of the microphone, when the set is to be used as a telegraph transmitter.

The effective construction of the filter system eliminates the commutator ripples of the generator. This is of great assistance when the set is used for radiophone work in destroying all unnecessary noises which will hinder satisfactory sneaking. This system consists of two specially designed iron core inductances, each one being connected in series on both sides of the high potential D. C. source. Two 1 microfarad condensers are shunted across these two inductances, and the en-

(Cont. on page 324)

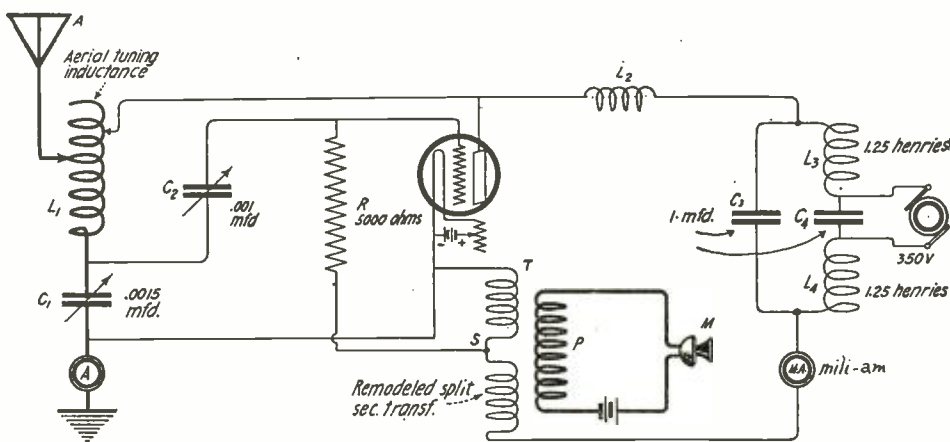

Schematic Wiring Diagram of the Above C.W. Transmitter. For Simplicity, But One Tube is Shown Here, But in Reality There are Three, All of Which are Connected With Their Respective Elements in Parallel. All Tubes Function as Oscillators.

*Illustrations by courtesy of S. Coher.

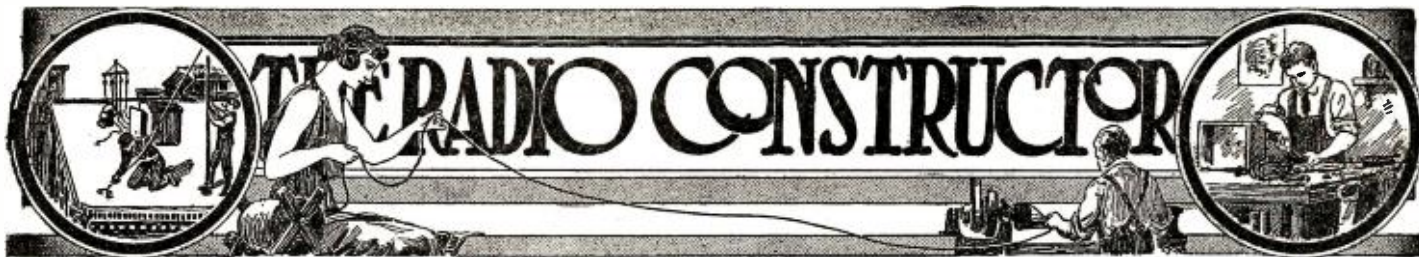

A Vacuum Transmitter Operating on a 6-Volt Storage Battery

By H. M. PRUDEN

THE main draw-back to installing a low power transmitter of the vacuum tube type in most amateur radio stations is the necessity of supplying a source of high voltage direct current suitable for the Plate. For this purpose motor-generator sets have proved to be very satisfactory, but at the same time quite expensive. The type of tube transmitter that will prove most popular will probably be the one that is the least expensive to install and maintain. The following is a description of a set used by

"impulse oscillator" have a very low decrement, and therefore carrying qualities similar to ordinary C. W. and modulated waves.

The complete circuit arrangement used by the writer is shown in the Fig. 1. The "Century" type buzzer is used as an interrupter for the primary circuit of the transformer. If a satisfactory 500 cycle interrupter can be built it may be attached directly to the transformer, as is ordinarily done with spark coils. The buzzer proves quite satisfactory for this purpose, how-

winding L-1. Winding L-3 consists of twenty-eight turns of No. 24 D. C. wire wound on a cardboard ring $4\frac{7}{8}$ " in diameter placed *directly over* the winding L-2 on the other tube. L-2 is tapped in two or three places to control the wave length of the transmitter. The coils are all wound in the *same direction* and connected as shown in the diagram, otherwise the circuit may not oscillate.

When this circuit is put into operation, light the tube, depress the key, and adjust the inductance L-2 until the wave length as shown on a wave meter or receiving set is 200 meters, or lower if desired, and then adjust the capacity of C-4 until the maximum reading on the radiation meter is obtained. The final adjustment is on the interrupter, which should always be adjusted with the tube lighted and connected to an antenna. Incidentally, it will be noted that the adjustment of the capacity C-4 is not at all critical.

The first model of this type of transmitter has been in operation at station 2-JP since early in September, and amateurs within a radius of 40 miles are reporting loud signals. We must patiently wait until the long-distance season opens before we can find out what the outfit really can do, but any one attempting to build a set of this type can rest assured that his trouble will be amply repaid when the set is completed.

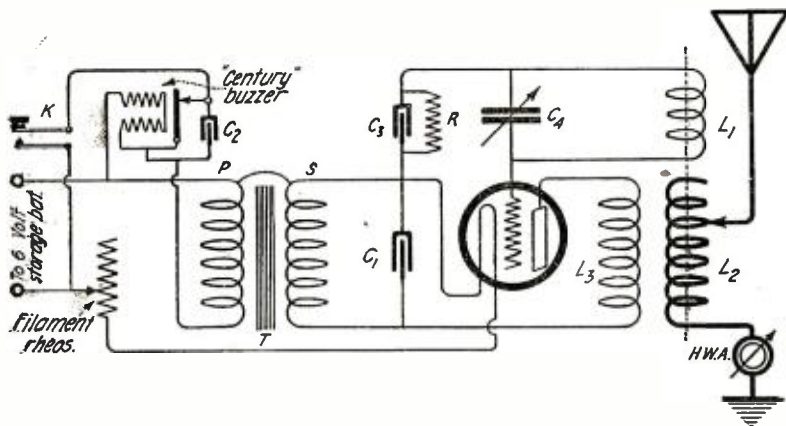

Fig. 1. Complete Circuit Arrangement of the Vacuum Tube Transmitter Built and Operated by Mr. Pruden.

the writer that has certain advantages over the ordinary vacuum tube type of transmitter, being less expensive to install and operate and at the same time producing more complete and perfect modulation than many of the systems used at present.

If alternating current instead of direct current is supplied to the plate of a vacuum tube connected in an oscillating circuit, it is evident that the plate will be positively charged during one-half of each cycle and the tube will oscillate, while during the other half of the cycle the plate will be negatively charged, and the tube will not oscillate. Thus the vacuum tube oscillator produces a complete wave train for each cycle of the alternating current supply circuit, which is preferably about 500 cycles.

The duration of the positive charge on the plate is one-half the period of the 500 cycle alternating current, or .001 second. Therefore, if the wave-length the set is tuned to is 200 meters, the period of the radio frequency oscillations is 66×10^{-8} seconds, and sufficient time elapses while the plate is positively charged for the oscillator to make 1500 complete oscillations. In actual practice the oscillations begin when the charge on the plate reaches about 30 volts, so if the effective voltage of the alternating current source is 400 or 500 volts, the tube will produce very nearly the entire 1500 possible oscillations. Wave trains produced by this

ever. It will be noted that the primary of the transformer is shunted around the buzzer windings instead of being connected in series with them. This arrangement passes more current thru the primary of the transformer. The transformer consists of the primary of a half or of a one-inch spark coil with a secondary winding of between 5,000 and 10,000 turns of No. 30 or No. 32 S. S. C. magnet wire. The exact number of turns depends upon the size of the core, the primary winding, and the type of tube used in the circuit. The resistance of this winding should be kept as low as possible to reduce losses. The current in this circuit is between 30 and 40 milli-amperes.

Condenser C-1 is a mica condenser of .001 mfd. and its purpose is to complete the radio-frequency circuit from the plate of the tube thru the coil L-2 to the filament of the tube. Capacity C-2 is a 1 mfd. paper condenser, and its function in the circuit is to prevent sparking at the contacts of the buzzer interrupter. C-3 is a .005 mfd. grid condenser and is shunted by a grid leak R of 10,000 ohms. C-4 is a .001 mfd. variable, and should be immersed in oil to increase its capacity to .005 mfd.

The inductance L-1 consists of fifteen turns of number 24 D. C. wire on a tube $4\frac{1}{2}$ " in diameter. L-2 is fifteen turns of No. 18 D. C. wire on the same tube, with a space of $\frac{3}{8}$ " between it and the

BE CAREFUL, FELLOWS!

There recently appeared in several newspapers of the country the following item:

Putnam, Conn., Oct. 13.—Ellsworth Sabin, 17, a high school student, was killed when he grasped a highly charged wire. He and William Mansfield were putting up aerial wires for an amateur radio outfit.

Judging from the above it would seem that one of our numbers had not been fully warned concerning the danger of landing foul of nearby high tension power lines which are so frequently found in suburban or rural districts.

It is when one is looking about for an aerial site that these dangerous lines are noticed and in stringing aerial wires it is quite possible to accidentally touch one of them. For that reason before you attempt to erect an aerial carefully make note of any nearby wires, no matter what they be; that is to say, do not always conclude that they are telephone or telegraph wires. Take no chances. Keep at a safe distance from unknown lines and under no circumstances have the span of your aerial either above or beneath such lines. Neither should they be placed close enough so that a wind storm would cause them to break loose and ground themselves on adjacent power lines.

Too much importance cannot be laid upon asking you to be extremely careful in putting up an aerial. SAFETY FIRST.

A V.T. Audio-Frequency Amplifier

By FRANCIS R. PRAY

It is a generally conceded fact that radio apparatus suitable for amateur use must be designed radically different from government or commercial apparatus, because of the amateurs' peculiar limitations. Then again, there are some advantages that amateur apparatus may have which are not permissible in commercial apparatus owing to patent rights.

Consider amplifiers for example. During the war it was necessary to use detector bulbs which were thoroly reliable, and to make them so they could not be as critically sensitive as the gas-filled tubes of the amateur field. Consequently, this lack of sensitiveness was made up by radio and audio frequency amplifiers, of a type which also needed little adjustment. This procedure is unnecessary, however, to give the amateur the results that his ideals now require, even tho they are now on a much higher plane.

The amateur may begin with a detector tube containing a small amount of gas. (An ordinary *low vacuum* tube is a "gas" tube since air is a gas.) The selection of a detector tube is a hard proposition just now because of the present limitations. The Audiotron is a very sensitive detector, but is noisy and often unreliable, changing its electrical characteristics during its life. The Class I Marconi VT, altho it is reliable and quiet in operation, oscillating easily and steadily for C.W. or long wave arc reception, is a poor detector of weak spark signals. It is adapted for use with three or more stages of amplification and if so used is excellent. Take your choice: Simple, isn't it; but let me offer a suggestion. Having burnt out my last "special" VT and not having any more immediately available, I took an old Class II Marconi VT, which turned blue in an ordinary amplifier circuit, put it in the detector socket and was surprised to find it had all the good points of the Class I tube and the Audiotron, with none of their bad features. If you have a Marconi Class II, try this, altho I will not venture to say that the same results will be had with all of them, as even these "highly standardized" tubes vary widely.

Having obtained a satisfactory detector, the amateur is ready to amplify his signals. His filament current supply is probably a storage battery or a flock of dry cells. He must remember that for every amplifier tube added an average of three quarters of an ampere must be drawn from the battery. He would LIKE to install an Armstrong seven-tube Super-Autodyne amplifier, but decides to wait a while after doing a little figuring with a pencil. He then decides, frequent trips to the battery-charging sta-

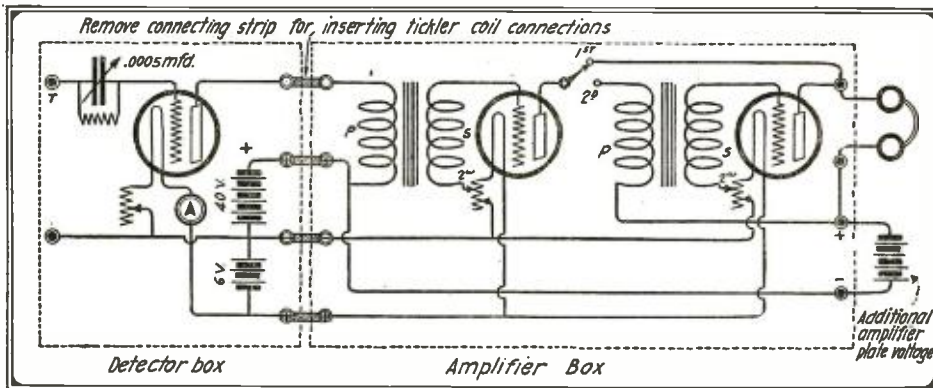

Complete Circuit Diagram of the Detector Unit Connected to the Two Stage Amplifier Box. Note the Two Point Switch for Changing from One to Two Steps of Amplification.

tion considered, that he will stop at the second stage of amplification.

It is quite practicable to limit the amplifier to two stages as a good antenna and ground system coupled to a modern regenerative tuning circuit, and the amplifier will be more than sufficient for amateurs who can recognize the value of a properly balanced outfit.

batteries are used with all tubes. This is a feature the ideal circuit should have, but the fact remains that amplifier VT's require about 20 volts addition in their plate circuit to make them operate on the amplification portion of their characteristic curve.

This is easily accomplished by using the accompanying circuit developed by the writer for amateur use. A single "A" battery lights all filaments and the detector plate circuit battery is also used in the amplifier plate circuit, to which may be added as much additional potential as needed.

Another feature seldom seen in amateur amplifier circuits is the additional resistance placed between the grid and filament, taking the place of a grid leak or battery, and preventing the tube "choking." This additional resistance may be obtained by merely tapping off a portion of the filament rheostat as shown. The proper point is best found by experiment, but may be about two ohms.

The outstanding feature of the circuit is a simple two-point switch for cutting out the second stage of amplification when it is desired to reduce signal strength or conserve filament battery. Every good two-stage amplifier now on the market has the step control feature, but in the form of telephone jacks or "anti-capacity" switches. Unless these devices are correctly wired, which is seldom the case, the closely bunched leads thereto will be a contributory cause of local oscillations, more familiarly known as "cross talk" and "howling." It is desirable, then, to have as little wiring as possible.

Another factor which causes howling is the crowding of amplifier coils and VT's in order to approach the compactness of war-time amplifiers.

Each vacuum tube should be separated at least three inches or else shielded by brass plates in some manner. The transformer coils should also be well spaced, or placed at right angles, or shielded. Then there is one more precaution. VT's in audio-frequency circuits are very sensitive to external vibrations and amplify these as well as signals. It is desirable, then, to use some sort of shock-absorbent VT socket such as made by the Somerville Radio Laboratory, and the panel, after being enclosed in a box, should rest on rubber feet.

In order to prove the above circuit practicable, the writer made a two-stage amplifier along the following plans, and was surprised at the low cost, which, at usual retail prices, not including the wooden cabinet,

(Continued on page 314)

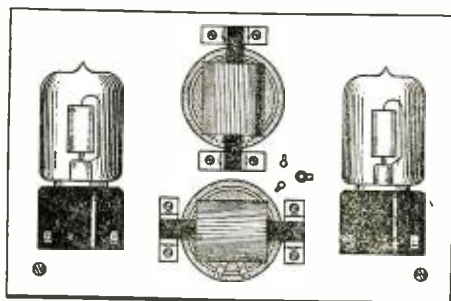

Illustrating the Back of the Two-Step Amplifier Panel. Note Right Angle Mounting of Transformers Over Each Rheostat.

Altho radio frequency amplification is preferable, it will be some time before the radio manufacturers will produce a really good amplifying transformer for these frequencies. As it is, considerable work has been done in putting out a highly efficient audio-frequency amplifying transformer, and the writer believes that A. transformer is the best proposition on the market at present.

The next consideration is the circuit. Many have appeared in print lately, whereby the same high voltage and low voltage

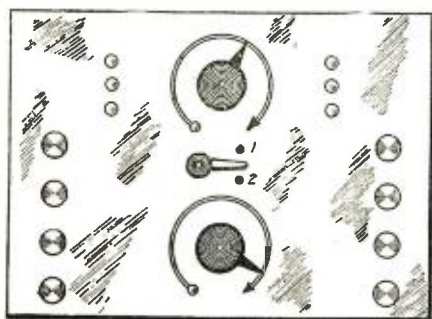

Front of panel

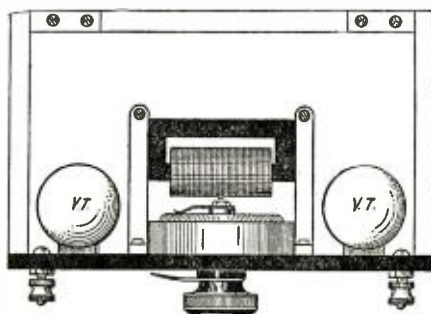

Top view

The Left Hand Sketch Shows the Front Part of the Amplifier Panel and Places for Binding Posts. Note the Small Holes for Observing the Tubes. To the Right is Shown a Top View of the Unit and Manner of Mounting the Transformers Directly Over the Rheostats Which is a Great Space Saving Factor.

Let's Go!

By CHARLES S. WOLFE

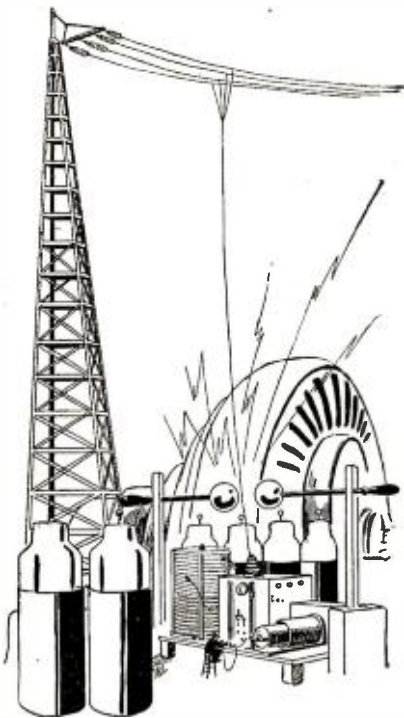

The Radio Station of Several Years Back With its Gigantic Aerials and Noise Making Apparatus is Slowly Going Into the Discard.

COME, brethren, let us for the present lay the 'phones on the table, take our fingers from our keys, and give the rotary a deserved rest. Come with me a while into the realm of meditation and speculation. Let us smoke and dream for a space.

Three decades have slid behind us since Marconi commercialized Hertz, little pastime, and started this thing; three decades which have been filled with shuffling footsteps, constantly pressing forward, eh? Coherer yielded to electrolytic responder, the responder wandered aimlessly into oblivion as the mineral detector bounded into the limelight, and the old chunk of silicon has meandered sillily into Little Willie's play box while Lee de Forest's hot hair pin in a bottle taps its chest and shrieks "Look me over, guys, lamp me."

Our Italian trail blazer used up quite a few human K. V. A. getting kits up into the azure to the end that several hundred feet of bare copper might dangle cunningly amongst the ether atoms; a proceeding which he considered quite essential. Governments expended many of their tithes setting up tall towers, managing, with the aid of a few hundred thousand dollars' worth of steel to protect a few cents worth of copper from the playful attentions of the tornado. Later a sixteen year old kid accomplished just as much with a couple of sixteen-foot poles on the roof—usually more, all things considered.

After our venerable forerunners had cursed away their chances of eternal bliss in vain endeavor to eliminate that omnipresent Third Party, yours sincerely, the tuning coil, makes its bow, and demonstrates.

Barely has this charming personage settled himself comfortably in our midst, when, with a hoarse chuckle the loose coupler drops his suit case, and fairly dazzles us with an exhibition of the thousand different forms he may manifest himself in. He's still at it.

Old stuff, all of this, but necessary to bring us to a receptive mood. Now let us start for somewhere.

As each newcomer presented himself, our tables mirrored the falling of the restless sands. From a couple of squares we reached out over a couple of miles, made it a couple of hundred, and with a swift leap annihilated a couple of continents. Good!

Today we sit complacently at our sets, spasmodically, jostling space with our half K. W.'s, juggling our plate voltage, and tinkering now and then, by way of diversion, with the radio 'phone. Lee holds full sway, and *nothing* surrounded by glass is the sand—on which we build our house.

We sit complacently, when—we, above all others, should be in shirt sleeves and at it.

For the surface has been but scratched, and so long as a single mast frets on a house top, so long as a coupler—disguise it as you will—acts as a sieve, so long as a screeching rotary makes night hideous, until, I say, all the instruments necessary for hurling intelligence from pole to pole and around the globe sit compactly before us on a desk top, we should be ceaselessly at it. There are a hundred pathways just yelling for some one to follow along them.

We waste too much time, all of us "Q. S. T.'ing" and "C. Q.'ing" when we might be bringing to light the Audion's successor. You don't for one moment doubt that it will have one, do you? We sit up on our hind legs and howl about interference and jammed traffic when all that we amateurs say to each other in the course of a year amounts to just about nothing. Nine million, "How's My Sparks!"

Nay, brethren, to sit night after night tossing two hundred meter commonplaces around the duchy does not stamp you as an investigator. It brands you as a kid with a new toy.

This vibrant ether business, citizens, looms up as about the biggest thing that has come to light since Adam went into the apple industry. And as we gradually plumb its depths we are worming nearer and nearer to the mysterious force that keeps the universe whirling in space. Without sacrilege I say that when you set in motion a wave train you are knocking on the Creator's back door.

Therefore, let those of us who have been dabbling with this wonder cease dabbling and begin wielding the scalpel. Let us come out of the nursery of make believe messages and into the work shop of problem shattering. Let us investigate rather than communicate.

It is our privilege, at the end of the day, to enter earnestly into this work, untainted by commercialism, unspurred by the lure of gold, uninfluenced by the necessity of forwarding any particular interest. Truly a wonderful opportunity! Surely an unprecedented chance to slip the chains of the physical and realize—in a sense—another, a higher, dimension!

Enough! Let the clan hop to it. The loop is the most significant thing before us at present. Let us start with that, or rather, from that. Let us strive, not to perfect the loop, but to eliminate even that. Let us get the masts off the house tops, the spans into pill boxes. It has been said, often, that the energy of a buzzer is sufficient to girdle the old ball. No doubt. And no doubt a darned sight less will do the trick. It is for us to demonstrate.

One last word—to the wise. On the level, boys, the V. T. is nothing much but a feeler. Think a minute! It's about as sensitive as a wheel barrow!

NEWS FROM EL PASO, TEXAS

El Paso amateur wireless telephone operators have at last succeeded in communicating with nearby stations.

The first message that has been received over an amateur set in El Paso was sent to Le Roy Hill, 811 Oregon Street, Tuesday night, when Prof. R. W. Goddard, who lives in Mesilla Park, New Mexico, answered a message sent by Hill recently. This is the first amateur wireless phone in the city that has been able to send and receive to such distance.

The message read:

"El Paso, Tex., Oct. 12.

"R. W. Goddard,

"State College, N. M.

"Have sold transformer you borrowed to try out. Please send by return mail.

"D. J. McCANNE."

The reply follows:

"State College, N. M., Oct. 12.

"D. J. McCANNE,

"El Paso, Texas.

"Received your letter. The transformer is in the mail, will arrive in morning.

"R. W. GODDARD."

A number of amateurs have already secured sending sets and will fill the air in the near future with messages.

Carl Noll, who is now residing in Government Hill, is the first local boy to introduce amateur wireless to El Paso boys. Carl set up his first wireless when he lived on Oregon street, just across from LeRoy Hill, about a year before the world war. He was forced to take the set down during the war. Many of Noll's boy friends took up his plan and today small wireless stations may be found in many parts of the city. Hill was one of the first to follow in Carl Noll's footsteps.

The Boy Scouts have a good many wireless sets at present and Mr. Goddard is urging all scout leaders to erect their stations at once.

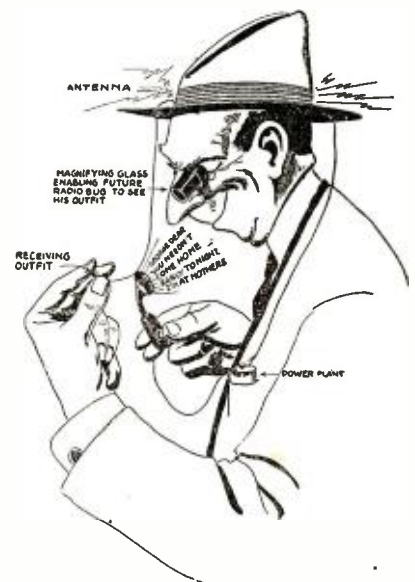

Behold! the Radio Station of the Very Near Future. It Will Take a Jeweler's Glass to Adjust the Receiver—Almost!

The Man Who Stands By

A Sequel to "The Radio Man's Code"

By ERALD A. SCHIVO

NOTHING disturbed the absolute serenity which pervaded the great passenger liner, gracefully plowing its way thru the crystalline waters of the Pacific Ocean. The unclouded sky, the glittering sun which caused an everlasting expanse of water to mirror its gleaming beauty, the incessant stream which traveled in the ship's wake, ruffled, white and sparkling, only added to the happiness of those on board the vessel.

Music, not that played for dance or song, but a classical composition, pleasing to the ear, a selection that one listened to in a state of rapture. The melodious passages penetrated from some ulterior part of the ship to the radio room, occupied by a single young man, the chief radio operator.

He listened intently, receivers removed from ears and chair tilted at a somewhat dangerous angle; he rested easily, feet perched conspicuously on the table before him.

The music stopt. Ralph Goodwin reached for the head phones and gingerly set them in place. Again the orchestra played, but this time for the many dancers who merrily whirled on the steamers deck. Goodwin cared little for such music and did not again remove the head set.

Few signals resulted as he tuned industriously with the complicated apparatus before him. Only the familiar buzz of the powerful San Francisco station could be heard intermittently. In the words of the operator "the air was quiet"—and he deftly entered that fact in the radio log, then resuming his favorite position, gave himself over to reminiscences of the past few days.

The death of the second operator was certainly a calamity. The entire radio work now fell upon Goodwin. Not only was it his duty to transmit and receive all radiograms for the ship, but he was also compelled to publish a small newspaper. What he and the second operator had started must be continued. Everyone on the vessel now demanded the news of the day and were quite willing to pay for it.

Goodwin sighed audibly. Three more days and the steamer would arrive at her destination. It was not possible that an operator might be procured in China. Likely he would have the return voyage without the addition of another man. Heart failure! Who would have thought the robust second operator was afflicted with such a deadly disease.

Goodwin was almost sorry he had accepted the more advanced position on board the passenger liner; not that he disliked the extra work, but he missed the com-

"Send the S O S Signal Quick, We're Sinking!" Shouted the Captain."

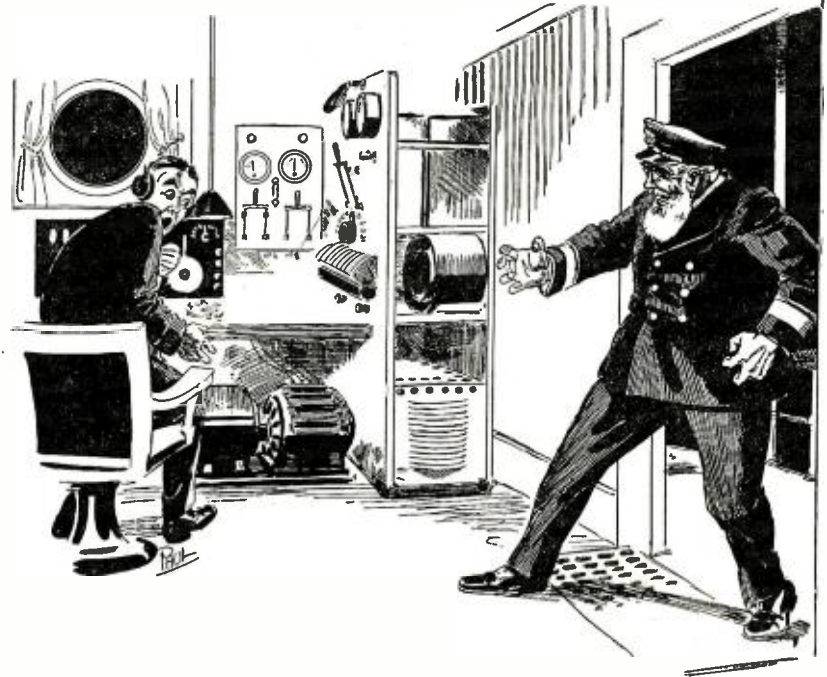

panionship which existed on board the *Orion*, a freighter, from which he had been promoted upon the recommendation of her captain.

For some reason, the death of the operator, Goodwin furnished a premonition of impending disaster. He could not define the perplexing restlessness that sometimes passed over him. What catastrophe might overtake the vessel he could not determine. The weather was perfect, had been since the Golden Gate was left far behind.

The hours slowly dragged by. Night enveloped the liner. Everyone was silent. All hilarity had subsided. Only the ship's powerful engines could be heard as a distant murmur.

The ocean was as a sleeping child, peacefully resting for the morrow's mischief. Bad weather was unthought of. The moon high in the heavens, smiled with incessant brightness on the slumbering waters.

Two hours passed, then came the loud voice of a man. Louder and louder became the incoherent cries, becoming more audible as the crier raised his voice.

Like the roar of thunder suddenly breaking the silence of a perfect day, the ship turned into a clamorous mass of humanity.

The vessel's engines stopt; men cried out in fear; women screamed, children, grasped in mother's arms, added to the din with high pitched yells. All scrambled in a mad race for the lifeboats.

Officers of the vessel, horrified, tried to stanch the wild commotion that would in many cases result in death. Warning revolver shots were fired but to no avail; and all this time the master of the huge steamer, the man respected by everyone because of his great responsibility, was howling in a deep, powerful voice: "Man the lifeboats! Everybody to the boats for your life, and bring your life belts!"

No one could quell the resulting rush. The officers tried in vain, pleaded, threatened; all but killed with their ready revolvers.

Toward the radio shack the captain now made his way. Goodwin, pale but determined to stand by, was surprised at the heinous features of the commander who entered the room noisily.

"Send the S O S signal," shouted the captain; "send the S O S, quick, we're sinking, the S O S!"

A grewsome grin overspread the master's face. A maniacal stare protruded from his eyeballs. The great man's hand passed through his disordered hair, then down the side of the face, cutting an ugly scratch with each finger nail.

Goodwin looked on in horror. The man had become a lunatic. Then the truth suddenly dawned upon Goodwin. *The vessel was no more liable to sink than the Hawaiian Islands.* There was no visible cause. The ship reposed easily on the calm waters. No doubt the captain had ordered the engines stopt before giving forth his erroneous exclamations.

Something must be done immediately if life was to be saved. Should he send the "S O S" as the captain ordered? There was no danger of the steamer sinking, he was now certain of that. No good would result. If the lifeboats did successfully leave the vessel, no doubt they would return when satisfied there was no cause for alarm.

(Continued on page 337)



"No one Could Quell the Resulting Rush for the Lifeboats."

RADIO DIGEST

AMATEURS IN GREAT BRITAIN

The new rules governing amateur operation of radio apparatus in the British Isles provide that no amateur may erect an aerial more than 100 feet in height, or more than 100 feet above the ground. Other restrictions govern the transmitting power permitted and the wave-length of amateur stations. There are forty-one amateur radio clubs in the United Kingdom, with a membership of over 1,500.—*Telegraph and Telephone Age.*

A DOUBLE-ANODE VACUUM-TUBE A.C. RECTIFIER AND WIRELESS TRANSMITTER

By John Scott-Taggart

The following description of a novel full-wave rectifier of alternating current may be of interest. A single highly-exhausted vacuum tube contains two cylindrical anodes, which surround a common filament which is heated to incandescence. The structure is particularly applicable to high-power valves, and more simple tubes are made of small powers and for use in receiving circuits. The source of current to be rectified causes the potentials on the anodes to be of opposite sign at any given moment; consequently, the flow of electrons from the filament passes to each anode in turn.

The type of valve mentioned has numerous applications in wireless reception and telephony. The writer is indebted to the Edison Swan Electric Co., Ltd. (which has purchased the British patent rights) for permission to publish the above details.—*The Electrical Review*, Sept. 3, 1920.

AMPLIFICATION OF ELECTRIC CURRENTS IN THE BUNSEN FLAME

By C. W. Heaps

Modulation of Electric Currents in a Bunsen Flame; the Use of a Third Electrode.—When an electric current is sent through a Bunsen flame, entering and leaving the flame by platinum terminals, it has been found by the author that amplification effects similar to those in vacuum tubes may be secured by the use of a third electrode or grid placed near the lime-coated cathode in the flame. The potential of this grid is varied with respect to the cathode and direct current characteristic curves are given showing the current as a function of the grid potential. These curves are similar in appearance to those obtained with the audion, and may be utilized in the customary way for calculating the *amplification constants*. The factors influencing these amplification constants are discussed and it is found that under what are probably the most favorable conditions of the apparatus used, the voltage amplification is but little greater than unity. The power amplification is about 108 and the current amplification about 101. *The theory* of the action is outlined in a general way, the effectiveness of the grid is being ascribed to its retarding influence on the electron emission of the cathode. A consequent change in the cathode fall of potential alters the current through the flame. *The utility* of the device is not comparable with that of the vacuum tube amplifiers, largely because of the difficulty of securing permanent flame conditions. The energy output of the simple device used was also necessarily small because of the high flame resistance. It could be used, however, for the detection of electric waves.—*Abstracted from Physical Review.*

REMOVAL OF AUSTRALIAN RADIO AMATEUR RESTRICTIONS

The Wireless Institute of Australia has more than justified its existence. Due very

largely to the persistent efforts of its Council, the Commonwealth Parliament has at least passed an Amendment of the W/T Regulations, and recently saw the removal of nearly all the impediments to and restrictions in the use of wireless apparatus for experimental and instructional purposes which existed during the war.

These regulations provide that any natural born British subject, male or female, residing in Australia may obtain a license to use wireless telegraph and wireless telephone apparatus for the purposes above named.

This freedom of the ether is given to a type of enthusiast who has existed in large numbers in the past and will be considerably augmented in the future.

Before the war there were about *one thousand people in Australia* using wireless apparatus for experimental purposes. The scope and possibilities of the science have extended so widely during the past five years that it will attract a much larger section than before. Clearly the new amendment is not intended to impose any undue restrictions on the individual, thus proving that those responsible for drafting the amendment now realize that the ether is a common highway, and that all have equal rights to its use.

Fortunately for the future of wireless development, the antiquated idea that universal ether could be fenced off, labelled and ticketed by some particular section of the community, or by some department of the Government accustomed to enjoying unchallenged monopolies, has largely disappeared. At last the truth is realized, that the supposititious ether fills all space and permeates all matter and is infinite in itself—that this thing must not and cannot be hamstrung by a limited conception of what it really is. Moreover, the possibilities of the science itself are almost as unlimited as its extent, because in only a few years we have developed from the comparatively old systems of telegraphing across a few hundred miles, to the greatly superior methods of the present day which enable us to listen to Melba at a distance of over 1,000 miles, or to pick up messages across the whole circumference of the world.

And yet it is in its infancy.

The Government, therefore, has at last recognized that one cannot make any hard and fast rule to control the ether, and has acted accordingly.—*Gleaned from Sea, Land and Air.*

EARTH SYSTEMS OR "GROUNDS"

By George Apperley

The vital importance of a good earth in conjunction with the aerial for radio work is well known and emphasized in all standard works on the subject, but how many experimental stations equipped with high grade and modern apparatus are rendered more or less inefficient by superfluous resistance in this section of the system? In many stations the earth wire can be traced to the water tap. This method of securing an earth connection does give results, but how much better will the station work if a better earth connection is secured? Probably the most perfect earth possible is that obtained by the hull of an iron vessel afloat in sea water, but even this possesses a certain amount of resistance. The aim of the experimenter should be to secure contact with the earth with as little resistance as possible and in such a manner as to ensure its value remaining unaltered. Provided an earth system is composed of three similar sections its approximate resistance may be measured and thus some idea obtained of its efficiency. Moreover, this measurement may

be made from time to time to determine whether the resistance is constant.

When putting down an "earth" the initial cost and durability call for first consideration. Probably the cheapest form consists of galvanized iron wires and plates, but the more durable, of copper. The latter metal is, of course, very much superior to iron as regards conductivity, but its high price makes its use almost prohibitive. The plates should be buried edge-wise concentrically about the foot of the antenna. Usually three plates about three feet square will suffice.—*Abstracted from Sea, Land and Air.*

WESTINGHOUSE ENTERS THE RADIO FIELD

One of the important recent developments in electrical industry is the entrance of the Westinghouse Electric & Manufacturing Company into the radio field. Altho prior to the war this company was not commercially interested in wireless, it had devoted a great deal of attention to radio phenomena, and during the war it not only carried out extensive researches for the Government, but also manufactured a large amount of apparatus for military use. It is, therefore, well equipped to assist in developing the immeasurable scientific and commercial possibilities of this new art; and the addition of its resources to those already engaged in this line of work will undoubtedly benefit the entire industry.

"THE BUZZER"

An interesting little publication traveling under the breezy name of *The Buzzer* is being published "now and then" by and for the soldiers of the Sixth Field Signal Battalion, Camp Grant, Illinois.

The paper is filled with good cheer, comradeship and information having to do with the life and work of the Signal Corps branch of the U. S. Army, where radio plays such a valuable and important part.

Young men casting about for a life filled with adventure, technical training and proper living would do well to investigate what this branch of Uncle Sam's service has to offer.

RADIO IN THE BRITISH MERCHANT MARINE

By H. Maccallum, B.S.C.

Notwithstanding the fact that remarkable technical progress has been made in wireless during the last five or six years, no great advancement has been evident in its practical application at sea until just recently, and it would almost appear to the onlooker that radio in the Merchant Marine had reached a period of stagnation. It is true that something like stagnation in commercial wireless occurred during the war, but there are very good reasons for this. The maximum output by all manufacturers of apparatus in any way useful for war purposes was essential at that time, and in the case of the Merchant Marine, the existing patterns of apparatus met all requirements. The only valid reason for introducing new patterns was to cheapen and expedite manufacture, or more efficiently to utilize the material available. With the exception of one or two minor alterations in design, introduced with this object in view, the apparatus fitted to ships in large quantities during the war was of pre-war pattern. The energies of designers were fully employed in bringing out new patterns of wireless gear for use in the theatres of war, and it is in this direction that the technical advances referred to have been made.—*Abstracted from The Electrician (London).*

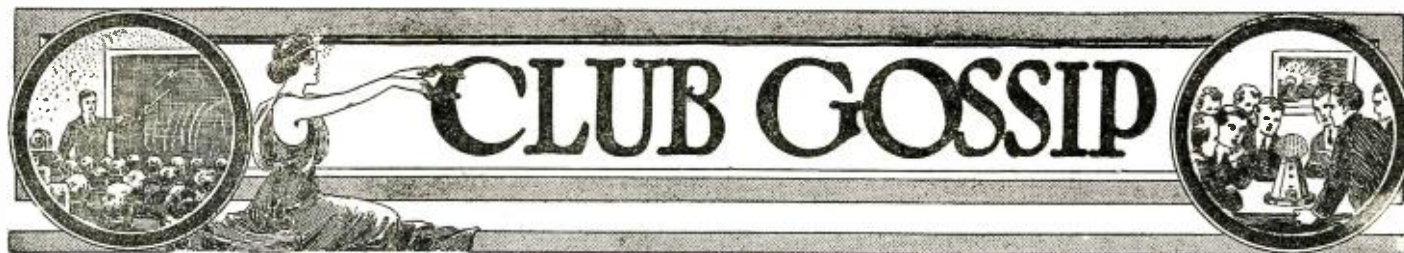

EUREKA RADIO CLUB.

The Eureka Radio Club has been enlarged, with headquarters at Eureka College, where a room was given for the use of the club.

The first meeting was recently held with a good attendance of students and radio men. This gathering was open to a general discussion of organization and division of membership.

A technical course in wireless under a competent instructor has been arranged for the club—also an elementary course for the junior membership. Meetings are held each Monday.

Officers elected are as follows: President, Paul Rosborough; Vice-President, Coral Jury; Traffic Manager, Ivan rane; Librarian, Mary James; Secretary-Treasurer, Henry Klaus.

The club will be glad to correspond with other schools and wireless organizations. *Henry Klaus, c/o Eureka Radio Club, Eureka, Ill.*

BEDFORD B'KLYN RADIO CLUB.

The Bedford Radio Club, 420 Gates Ave., Brooklyn, N. Y., would like to get in touch with amateurs to devise ways and means of getting the most out of wireless work in ways of working together and arranging sociable times and visits and radio outings to places of common interest.

The Bedford Radio Club is planning a 3-months' course in Wireless Instruction for beginners.

All who are interested may apply to the Club's Secretary, James Corcoran, 420 Gates Ave., Bklyn.

THE WIRELESS SOCIETY OF LONDON.

A meeting of this Society took place on September 30th, at 6 p. m., at the Institution of Civil Engineers, Great George St., Westminster (England).

A lecture was given by Mr. Maurice Child on his "Personal Experience in the Construction and Working of an H. F. Amplifier."

The Committee are still open to receive suggestions from members for lectures and papers for the forthcoming session, and it is hoped that members who can offer anything of interest will communicate with the undersigned as soon as possible. *H. L. McMichael, Hon. Sec., 32 Quex Road, West Hampstead, N.W. 6.*

CENTRAL RADIO CLUB OF NEW YORK CITY.

Recently the Central Radio Club of N. Y. was organized by sixteen amateurs of Harlem and Washington Heights, New York.

Meetings to be held every Tuesday night at the homes of its members.

The following officers were elected: Geo. T. Weber, president; Oscar Johnson, vice-president; Henry Muller, secretary-treasurer; Henry Bock, librarian; all of whom are well known throughout this section.

Our president will lecture at our next meeting on C-W, on which subject he is an authority, having done special work along these lines during the War. Following this we will have a little talk on Wave Meters by the vice-president. And at the following meeting, secretary-treasurer Muller will give us a little talk on the "How and Why" of Amplifiers, with the assistance of Librarian Bock, who will draw diagrams and sketches on a black-board.

Our president and vice-president, have both sailed the "Seven Seas" as operators, and will tell us, as well as show photos, of their many experiences. All amateurs who are interested in a good "live-wire club—drop a line to A. Silverstein, 257 West 111th St., New York City, who is handling this work at present.

CENTRAL MAINE RADIO CLUB.

The Central Maine Radio Club of Waterville, consisting of the following members, Harold Clafin, Arthur Hustin, Stephen Ayer, Charles Libby, Earl Crawford, and Emery D. Austin, was organized and held its first meeting December 23, 1919.

The following officers were elected: Harold Clafin, president; Stephen Ayer, chief operator; Emery D. Austin, secretary and treasurer.

A committee of three were elected to draw up a set of by-laws. Meetings are held every two weeks on Tuesdays. Anyone residing nearby interested in Wireless is cordially invited to attend any of these meetings.

At a recent meeting it was voted to affiliate with the A. R. R. L. As Waterville is a small town

we are very proud to say we have over 25 members. We expect to increase this to 40 by December. All letters should be addressed to the secretary, Emery D. Austin, 1TK, Central Maine Radio Club, Waterville, Me.

SENECA, N. Y. RADIO ASSOCIATION.

The first meeting of the Seneca Radio Association of Geneva, N. Y., was held on September 10, 1920.

As soon as it is found convenient, a business meeting will be held and the affairs of the association will be straightened up and all old business attended to.

The association will be pleased to hear from anyone interested. Address all communications to the secretary, Clifford H. Daykin, 331 Washington St., Geneva, N. Y.

THE RADIO RESEARCH CLUB NEW YORK CITY.

We report the Re-organization Meeting of the Radio Research Club. After a suspension of activities for two months the club has again re-

Radio Articles in the November Issue of Science and Invention

(Formerly Electrical Experimenter.)

A 300 KW. Radio Transmitter at Bolinas, Cal.

The Audion in a New Role—A Remarkable New Detectaphone and Electro-Therapeutic Machine.

Simplest Long Wave Audion Receiver. By Elliott A. White.

How to Become a Professional Radio Man—Part 3—Conclusion. By Pierre H. Boucheron.

Amateur Radio Laboratory Prize Contest.

Question and Answer Column.

sumed its activities and this coming season promises to be one of the best in the history of the club.

On Friday evening September 24, the re-organization meeting of the R. R. C. was held. Many of the old members were present and plans were made for a greater organization and more adequate facilities to handle the affairs of the Club. Various committees were appointed by the chairman to carry on the good work of the Club. Mr. Hertzberg then gave a very interesting lecture on wavemeters and their calibration. This finished the program for the evening and the meeting was adjourned with the good wishes of the members for the continued prosperity of the Club.

All inquiries should be addressed to Jonas Cohen, 789 East 163rd St., New York City.

A NEW ZEALAND RADIO SOCIETY.

It may interest fellow readers of RADIO NEWS to know, that by combining ourselves, throughout this country into an Incorporated Society instead of separate Clubs, we have secured one of our main objects, i. e., the obtaining of licenses to carry out experimental work among ourselves, as is permitted in other countries.

For the benefit of members, the Society is divided into "Centres," which I think is very advantageous. The Auckland Centre was formed six weeks ago, and now has a membership of 52 enrolled. Wellington, our headquarters, I believe have 120 members, so that for our population, we are doing very well, as there are other centres of which I have not received report of the members. Interested persons may communicate with *Robert F. D. Bunnell, Secretary, Box 1166, Auckland, New Zealand.*

THE SAN ANTONIO RADIO CLUB.

The newly organized San Antonio Radio Club, now holds regular meetings at the city Y. M. C. A. Building.

The officers of the Club at present are: President, Sgt. Shelton; secretary, G. T. Atchison; treasurer, L. D. Wall.

The Club holds meetings each Wednesday night of the week.

There is quite a number of two-stage amplifier receiving sets being installed here now, and we expect to do much long distance receiving work this winter.

Interested persons may communicate with the secretary, Mr. G. T. Atchison, 3712 Roosevelt Ave., San Antonio, Texas.

NEW YORK BOY SCOUTS RADIO CLUB.

A Radio Club is to be organized amongst the Scouts of Manhattan, N. Y. C., and that from their Headquarters each night a message will be sent "Broadcast" telling the events of the day. At Headquarters, Mr. Schwartz who was an operator in the U. S. Navy, will have charge of the Club and station and will have the co-operation of some well-known amateur operators. For further information kindly write to Mr. Schwartz at The Boy Scout Headquarters, 73 Madison Ave., New York City.

SPRINGFIELD RADIO ASSOCIATION.

A delegation from the Springfield Radio Association recently made a trip to Hartford, Conn., where they applied for membership in the American Radio Relay League and also paid a visit to 1AW, the station of Hiram Percy Maxim, president of the A. R. R. L. Mr. Maxim gave the delegates a royal welcome and a most enjoyable evening was spent "listening in." Several members of the Club communicated with friends in Springfield, although static was very troublesome. Mr. Maxim invited the entire Club to a convention of radio "bugs" which will be held in Hartford next fall.

Now that the association has completed the installation of a receiving set, it has made two definite aims; first, to raise enough money by October First to install a complete ½ kilowatt transmitting station, and secondly, to have every member a Government licensed operator by December first of this year. To secure the latter aim, code instruction classes have been organized which will meet Wednesday and Friday evenings beside the regular meeting night on Tuesday. These classes will meet in the Club rooms at 19 Orleans St., Springfield, Mass. *Philip C. Humphrey, Publicity Mgr.*

THE EL PASO RADIO CLUB.

The El Paso Radio Club was organized March 15, 1920. Officers are: President, Le Roy Hill; vice-president, Albert Murdock, Jr.; secretary, Fred Whitlock. Members are Cyril Edmondson, Jack Ryan, Robert Stewart, Frank Stencil, Claude Hammel, Fordes Jones, Charles Bush, Fred Price, Morton Oliver, and Reis Beddow. The purpose of the Club is to prevent amateurs from interfering with Government stations. All members are required to have a set and know thoroly the operation of it. All transmitting stations are required to have a spark frequency of at least 200 cycles. Members are required to keep their stations in first class condition and never to exceed two hundred meters in transmitting. Code practice among amateurs here is only allowable from 7 until 9 p. m. Members disobeying rules are expelled from the Club. A listening station is in town to listen for amateurs interfering with Government messages.

The reason for not allowing code practice in day time is that the aeroplanes work on three hundred meters and several times amateurs have prevented communication.

The El Paso Radio Club promises to aid the Government in all possible ways to prevent interferences. *Le Roy Hill.*

ESSEX COUNTY RADIO CLUB.

A meeting of the Essex County Radio Association was held at Salem Fraternity on Central St., recently, open to every one in the Salem section, which includes Peabody, Danvers and Marblehead. Anyone interested in wireless or electricity is welcome to future meetings.

(Continued on page 335)



THIS Department is open to all readers. It matters not whether subscribers or not. All photos are judged for best arrangement and efficiency of the apparatus, neatness of connections and general appearance. In order to increase the interest in this department, we make it a rule not to publish photographs of stations unaccompanied by a picture of the owner.

We prefer dark photos to light ones. The prize winning pictures must be on prints not smaller than 5 x 7". We cannot reproduce pictures smaller than 3½ x 3½". All pictures must bear name and address written in ink on the back. A letter of not less than 100 words giving full description of the station, aerial equipment, etc., must accompany the pictures.

PRIZES: One first monthly prize of \$5.00. All other pictures published will be paid for at the rate of \$2.00.

New Mexico State College Radio Club Station

By R. W. GODDARD

THE State College (New Mexico) Radio Club had its inception when several ex-service men got together last year to swap yarns, discuss wireless experiences in the war; in brief to fight the war over again. As this College

had trained army men in this branch of the service and had an extensive amount of equipment that had been used for that purpose stored away, it was suggested that it might be possible to get the use of this apparatus and set up an amateur station. This permission was readily obtained from the College authorities and immediately plans were made to carry out the idea. But when it became known around the Campus that a station was contemplated, a considerable group of students instantly expressed their desire to be in on it. This led to the organization of the Club. A preliminary meeting was held early in October, 1919. Plans were definitely laid and officers elected for the year. A Constitution Committee was appointed and dates set for subsequent meetings. At a later meeting the constitution and by-laws were adopted.

Work on setting up the station was begun immediately. The Radio House that had been built and used in the field to the South of the College Hospital was moved to the angle of the Engineering Building. A tall iron pipe mast was erected on the tower of the latter building. Unfortunately, before this mast could be guyed, a heavy wind storm came up and destroyed it, dropping it in three pieces through the roof of the Engineering Building. But this was no damper to the enthusiasm of the Club members. They immediately set to work on another. This "stick" was designed somewhat differently and every precaution was taken that no ill befall it. It went up into the air 133 feet according to schedule amid the cheers of the whole club and half the student body one fine Saturday morning. The aerial, a four-wire inverted L with a flat top of one hundred feet had its outer end hoisted to the top of this mast while the other end was supported by a shorter forty-foot pipe mast erected at the end of the Radio House. With this aerial up it was not long before the fellows were listening to NPL (San Diego); NPM (Pearl Harbor, Hawaii); NPG (San Francisco);

NFF (New Brunswick, N. J.); NSS (Annapolis, Md.); NWW (Tuckerton, N. J.); NDD (Sayville, L. I.); XDA (Mexico City), and a host of other stations of high power to say nothing of the swam of smaller ship and coast stations which come

antenna through a Murdock series condenser and to the ground lead through a General Radio Co.'s hot wire ammeter. All of the lighting and power circuits are protected by resistance or condenser "kickback" protective devices. The ground is a ¾-inch pipe running directly into the water system of the College. The antenna switch is a single pole 100 ampere three position switch. The knife blade is mounted directly on the 17-inch lead in bushing while the contacts are mounted on 10-inch electrode pillars. The upper position throws the antenna to the transmitter, the middle position to the receiving sets, while the lower one grounds the antenna direct. The switch is operated by a cord with handles convenient to the operator's position.

The receiving is accomplished on two sets. A Duck short wave regenerative set with audiotron panel is used on waves below 600 meters while a large loose coupler with a DeForest ultraaudion detector brings in the longer waves. A two step amplifier is available for amplification of signals from either set.

Besides the radio equipment the radio house has a table fitted with keys and head sets for code practice. Audiofrequency current for this is obtained from the commutator of a small D. C. motor. There are also racks for books and magazines of which the College Library supplies the leading ones devoted to radio.

The Club holds regular meetings every Monday night at which time topics of interest are discussed and different pieces of apparatus are explained and tested out. It is also planned to have an inspection trip soon to El Paso, Texas, to see Fort Bliss (WZO) and the army airplane radio at the flying field there. A banquet will also be held at that time. Our college calls are: 5XD, 5FY, 5FZ, 5CX, while my own calls are: 5XJ and 5CW.

THOSE LIZZIES AGAIN.

First Amateur—"Bill is getting quite expert in his tuning."
Second Amateur—"How come?"
First Amateur—"He can now tune in the Fords that pass his house in the night."
—Joseph Thompson.

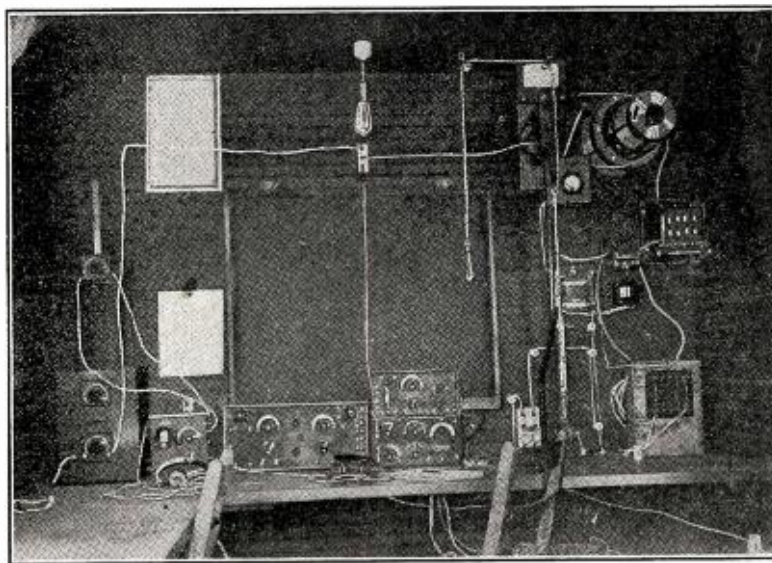

Interior View of Radio Shack of this Progressive College. Note the method of operating the antenna switch by means of the cord pull—an arrangement somewhat similar to that employed on some battleships. Plenty of "listening-in" space too.

in like the drone of honey bees about a cherry tree in full bloom.

The equipment for the transmitting end of the station was slower in erection as it was decided to make a number of changes over the old layout used by the College during the war. But this was fitted up soon after the Christmas holidays and great was the rejoicing when word was received that we had been heard by 5ZA in Roswell, N. M., 150 miles away over two high mountain ranges and a desert. From this to a regular schedule with other amateur stations was but a step. This station has done real work on several occasions sending results of athletic events to various home towns of visiting teams. The club is affiliated with the American Radio Relay League and hopes this year to be in the Southern transcontinental relay line.

The transmitting equipment as shown in the photo comprises a ¼ K.V.A. Packard transformer with its secondary connected across an eight stud rotary gap. The closed oscillation circuit includes the gap, four sections of Murdock molded condensers and a Duck commercial type scillation transformer. The secondary is connected to the

Henry H. Pike Station

Here is a photograph of my radio station, my official call being 4Dy. The receiving cabinet on the left, constructed by myself, contains the following apparatus: N.A.A. receiving transformer, one fixed and two variable condensers, electron relay and controls, galena detector, 3000 ohm phones and a loading coil with which I can tune up to 10,000 meters.

The transmitting panel on the right contains a home-made oscillation transformer and spark with a Ford spark coil.

My aerial consists of four wires 60 feet long and 40 feet high with a 15-foot lead in.

With the above apparatus I have been able to copy a number of stations. Among them are N.A.A., N.Q.R., N.A.T., N.A.Q., N.E.V. and N.A.M. I have been able to work a number of amateurs with my transmitting set and would be glad to hear

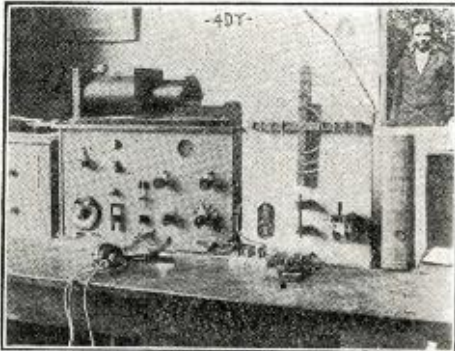

Pike By Name But No Piker When It Comes to Radio Enthusiasm.

from any amateurs near here who would like to communicate with me.

HENRY H. PIKE,
206 Park Avenue,
La Grange, Ga.

WIRELESS LIGHTS TO GUIDE AIR MAIL PLANES

Small electric lights operated by wireless placed on the front of the machines will guide the planes at night on the transcontinental air mail route between Cheyenne, Salt Lake and San Francisco, explained Colonel John A. Jordan, superintendent of the western division of the air mail service recently. Colonel Jordan, who had just arrived from the east, consulted with S. R. Inch, general manager of the Utah Power & Light Company, relative to obtaining power for the operation of the radio station to be established in Salt Lake.

"The lights," Colonel Jordan said, "will be tuned to the wireless instruments of the three cities in such a manner that they will shine only when the planes are within a certain radio path about 200 feet in width. When a plane strays from this path the lights will go out and the pilot will be obliged to determine by the wind on which side of the route he is traveling. Approach to the destination will be signified by a flashing on and off of the lights. The process has proved a success in thorough tests and is owned by the government."

Authorization for building the Salt Lake radio station on the site selected at the State Fair grounds was given by Colonel Jordan, and he further declared that employees of the plant and the landing station, as far as possible, will be selected from among local applicants. About eight men will be required at the radio station and about twenty-five at the landing field. He estimates that work on the hangars and plant will be well under way by December.

Son of Secretary of War and His Bike Station



Jack Baker
of Washington,
D. C.,
'Listening in'
With His Bi-
cycle Set.

Phil McGook, from Hecker's Corner, Illinois, is not the only bird who can claim radio telegraphic honors. Here we have Jack Baker, son of Secretary of War Baker. He has studied radio telegraphy with the same enthusiasm that you have, and in addition to his home set has rigged up a portable outfit on his bicycle as the

picture shows. In fact he is such a "bug" that he has to be "listening-in" while riding around Washington. We are informed that he can pick up signals from the Arlington station without any difficulty by using the frame of his bicycle in a loop aerial arrangement, which is getting an earful on the run, we'll say. Let us hear from you, Jack, what kind of a station have you?

A New Transmitter Panel*

An Amateur Spark Set with a Professional Appearance.

The demand for an amateur spark transmitting panel at a moderate price was taken into consideration when this set was designed.

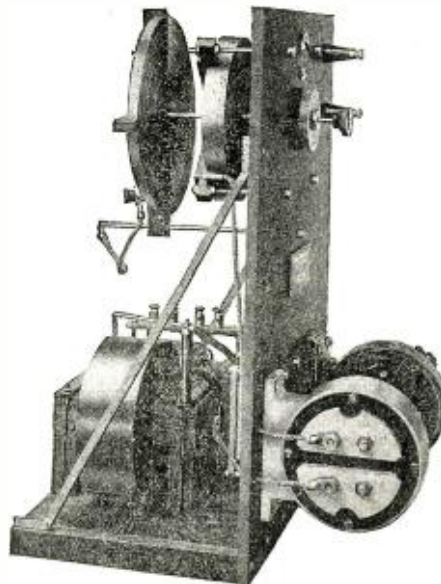

One Feature of This Panel Transmitter is the Hytone Rotary Quenched Gap Which Has Been Redesigned For This Set.

The instruments are mounted on a half-inch bakelite panel 16 x 24 inches. The panel is suitably engraved, and high-tension binding posts are mounted in the upper right-hand corner for antenna and ground connection. The "hytone" rotary quenched gap and motor are mounted on the front of the

panel as well as the knobs to change the coupling and primary turns of the oscillation transformer. The "hytone" gap has been redesigned and is of cast aluminum, which provides a very attractive finish when machined.

In the rear of the panel are mounted the transformer, Dubilier mica condenser and oscillation transformer. The oscillation transformer is constructed entirely of bakelite and nickel-plated copper strip. There are five turns in the primary and ten turns in the secondary. Adjustment of the secondary is provided for by a clip. All connections are of copper braid which provide against undue leakage and loss of efficiency. With an antenna of 10 ohms resistance this set is capable of over five amperes output.

RUBBER TUBE INSULATORS.

Many a "Ham" has to carry his lead-in over the edge of the roof and across the iron gutter—a place where troublesome leaks will occur, for the gutter is usually grounded. Try covering the lead in at this spot with several feet of heavy garden hose secured in place with friction tape; makes good insulator for small transmitters.

Speaking of rubber hose—can you find the one that led the gas to your old table lamp. Tear of its silk covering and you will find six feet of the best kind of insulation for high tension wires in the interior of a panel set, or any place where close wiring must have extra heavy protection.

Contributed by A. D. KEOGH.

SOME DROP!

"I saw a man fall off from a 300-foot radio tower without hurting himself."

"How did it happen?"

"He was only up two feet when he fell!"

CARLEY CONNOR.

*Illustration by author of Clark Eastham.



Junior Radio Course

The Vacuum Tube Detector

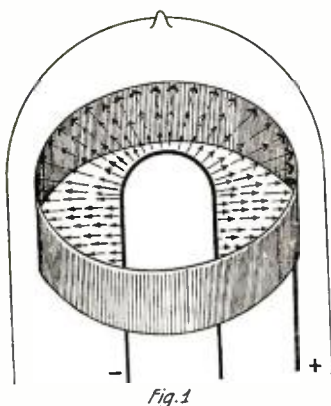

When the Filament is Heated Electrons Are Driven From the Filament to the Plate in Rapid Manner.

IN our study of the various detectors employed in radio communication, we now reach the most important and useful of all and that is the *Vacuum Tube*. The term Vacuum Tube has become quite general and popular, but other names are often employed and these sometime confuse the beginning amateur who wonders whether each name refers to a distinct and separate instrument.

So if you read or hear of such names as *audion*, *vacuum valve*, *electron relay*, *Fleming valve*, *oscillation*, *pliotron*, *audiotron*, you will know that these are in some cases pet names given by certain investigators while in other cases they are trade names employed by manufacturers to distinguish their own particular product from that of others. We, on the other hand, shall refer to this wonderful lamp as the Vacuum Tube, exclusively, which is often abbreviated to simply V. T.

It may be said that the entry of the Vacuum Tube has done more for the rapid advance of radio communication than any other given instrument. Not only that, but it is capable of performing more functions than any other electrical device. Its main and most important uses are for the three big factors in the radio of today, which are:

- Detection and rectification.
- Amplification of signals.
- Generation of oscillations.

Then too, new applications of the vacuum tube are gradually being made so that possibilities of further development are certainly promising.

WHO INVENTED IT?

You are naturally interested to know who is responsible for the invention of this wonder lamp. There are several investigators who had a hand towards its present practical form. Back in 1884, that great American inventor, Thomas Alva Edison,

took one of his incandescent lamps and observed that when the filament was heated to a white glow a very small electric current could be made to flow between the filament to a cold plate closely adjacent to it *in one direction only*. He called his device an "Electrical Indicator" and later it was named the Edison Valve. Years afterwards, Dr. J. A. Fleming of England applied the "Edison effect" to radio telegraphy for the first time, and he called his device the Oscillation Valve. This scientist was the first to employ the emission of electrons from heated filaments for the detection and rectification of radio frequency oscillations in a radio telegraph receiving system.

THE PART ELECTRONS PLAY

The Vacuum Tube is sometimes called an "electron relay," for that is just what it is—it relays electrons from the filament to the plate. An electron is the *smallest* particle of matter known to science, and it is supposed to carry the smallest possible charge of *negative* electricity on its travel from one body to another. In other words electrons really consist of very small amounts of negative electricity. In the case of Vacuum Tubes, electrons act as carriers of electricity between the filament and the plate which are separated in a vacuum.

Fig. 1 shows what takes place within the inside of a Vacuum Tube of the Fleming two-element type. By *two element* we mean the kind which employ simply a filament and a plate. The three element vacuum tube is the one employing filament, plate and *grid*, which we shall describe in the next lesson.

Referring again to Fig. 1, as soon as the filament of any electric incandescent lamp is heated to a red or white heat the filament immediately begins to emit or throw

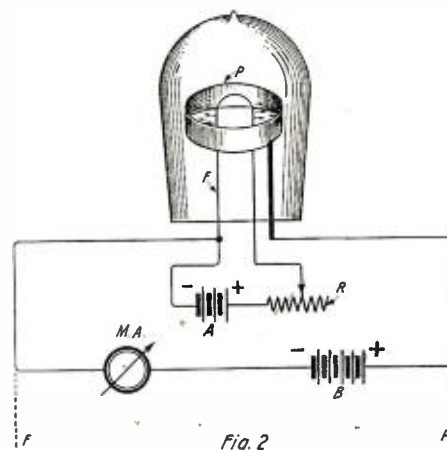

Simple Form of the Fleming Two Element Valve Illustrating a Source of Direct Current Applied to the Plate.

out electrons in a very rapid manner and in all directions. In the case of an ordinary lamp, these electrons simply hit the sides of the glass bulb. If, however, we place a small metal band around either the outside or the inside of the glass bulb and if we connect a set of dry batteries between the filament and plate so that the negative pole of the battery is connected to the negative side of the filament and the positive pole to this metal plate, these negative electrons will be *greatly attracted to the plate* because it is of a positive nature. If the plate be made negative instead, the electrons will be repelled and will try to find other landing places. It is simply a matter of *likes attract unlikes, but repel likes* as in the case of the permanent horseshoe magnets with their north and south poles which you often have played with.

THE FLEMING VALVE

In Fig. 2, we have a simple form of the original oscillation valve used by Mr. Fleming. F is a filament heated to incandescence by the battery A, the current of which is controlled by the rheostat R. If we connect a battery of cells between the negative side of the filament F and the plate P so that the positive side of this second battery is connected to the plate, we will find if we introduce a sensitive current meter such as the milliammeter M.A. (which will respond to the thousand part of an ampere) that a small amount of current is capable of passing thru the space separating the filament and the plate in one direction only, that is from the plate to the filament and this small current will register upon the milliammeter. On the other hand, if the polarity of this battery is reversed; i. e. if the plate side is made negative instead of positive, we will find that no current can pass thru the system.

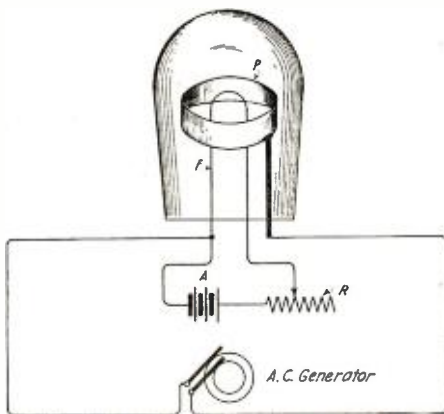

In this Case We Use an Alternating Current on the Plate Side to Demonstrate the Rectifying Principle of the Tube.

This action means that we have a *rectifier* at our disposal because if we substitute an alternating current for the battery B as in Fig. 3, we will find that only one-half of a cycle, the positive side, will pass thru, while the other half of the cycle (the negative side) will be unable to pass. Fig. 4 illustrates this action where the upper graph A is seen five cycles of alternating current that is *constantly changing from positive to negative* as it travels along a circuit, and which is the sort of electricity furnished by the A. C. generator of Fig. 3. Graph B of Fig. 4, on the other hand, shows what happens to the A. C. when it passes thru the Fleming Valve rectifier.

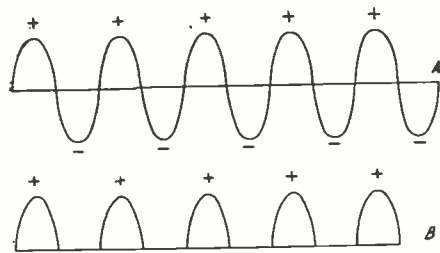

Fig. 4

The Upper Graph Shows an A.C. Before Rectification and the Lower Graph the Same Current After Being Rectified.

Only one-half of the five cycles remains—the positive half. As for the negative half it is not present. Thus, you see, you have the rectifying action of the valve and this same rectifying principle is employed to rectify the incoming oscillations of a radio telegraph receiving system.

THE FLEMING VALVE AS A DETECTOR

Since in order to receive radio waves it is necessary to first rectify their A. C. nature into a pulsating D. C. which will operate the telephone receivers and cause a sound to be heard, the Fleming Valve may be used as a detector on account of the rectifying action we have just mentioned.

Fig. 5, therefore, shows this two-element vacuum tube being used as a detector of radio oscillations. Altho this circuit is a very elementary one, it will function fairly well. In some cases, however, an additional set of batteries are used in the plate circuit with better results. The action of this circuit is a rectifying one; that is to say the incoming radio oscillations which represent the signals are rectified where but one-half of their alternations (that is their positive side) is permitted to pass thru to the phones as previously mentioned in the graphs of Fig. 4.

In our next lesson we shall take up the study of the *three-element vacuum tube*;

that is the one consisting of filament, plate and grid.

Questions for this Lesson.

1. What action did Mr. Edison discover in one of his early experiments with the incandescent lamp?
2. What is meant by the Fleming oscillation valve?
3. What part do electrons play in the operation of the vacuum tube?
4. Describe the rectifying action of the vacuum tube.
5. Draw a memory circuit diagram of a Fleming valve being used as a detector of radio oscillations.

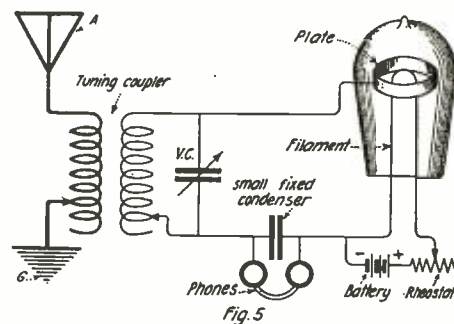

Fig. 5

Elementary Circuit Employing the Fleming Valve as a Detector in a Radio Receiver.

Dictionary of Technical Terms Used in Radio Telegraphy and Telephony*

Slip Rings—Two complete metallic rings separated by an insulator, from which the collecting brushes pick up the current generated by an alternator. They take the place of a Commutator on a direct current generator.

Slots—The teeth of core discs.

Sn—See Tin.

Sodium—Na. Natrium. Very soft, silver-white metallic element. A.W. 22.88. S.G. 0.98. Val I. Cehm. Eq. 22.88. Elec. Chem. Eq. 0.000,238,8

Solder—An alloy of lead and tin used for joining wires, etc.

Solenoid—A coil of wire having the property of an electromagnet. An electromagnet without the core.

Sounder—Telegraph receiving instrument. Consists of a brass armature, pivoted at one end over two electromagnets. Is connected up similarly to a single stroke bell. When a current passes, the magnets attract the armature, causing it to click against a metallic rest. Upon the circuit being broken, the key being released, a spring jerks the armature back into place giving a click as it strikes another rest. Dots and dashes are recognized by the time interval between these two clicks.

South Magnetic Pole—Situated in Lat. 70 South, and Long. 102 East. Does not coincide with Geographic South Pole.

South Pole—See Polarity of Magnets.

Spark Gap—A break in an oscillating circuit which acts as an automatic safety valve to the condenser. The air between the gap having a high resistance, the condenser cannot discharge until the potential is sufficient to break down its insulation, thus only permitting heavy discharges to take place.

Sparkina at Coil Contacts—Is due to inductances of primary winding producing a high voltage back flowing current at each interruption of supply current,

which sets up an arc between coil contacts, causing the platinum to melt and the contacts to stick by fusing together. Can be minimized by placing a condenser across gap.

Spark Micrometer—An instrument for accurately measuring the length of a spark gap. Not to be confused with a *Micrometer Spark Gap*.

Spreader—A spar or pole used for keeping the component wires of an aerial parallel to each other. A double-lugged steel band is fitted to each end to facilitate attachment to aerial and bridle by shackles.

Specific Gravity—S.G. The weight of a body compared with that of another having an equal bulk, taken as a standard. For practical purposes, of the heavier substances, water is the standard.

Specific Inductive Capacity—Of a medium it is the ratio of a condenser capacity having this medium as dielectric to the capacity of the same condenser having air as its dielectric. As all materials vary so greatly, the following figures are only approximate: Air 1, Mica 5 to 8, Glass 3 to 9, Ebonite 3, Shellac 3 to 3.5, India Rubber 2.5, Gutta-percha 2.5, Paraffin Wax 2.3.

Specific Resistance—Resistance of any material having a cube of one centimeter.

Spike—A pointed steel rod used for screwing shackles and also for opening out the strands of wire or rope for splicing.

Splice—The union of ropes and wires by the interweaving of their component strands.

Squared Paper—Paper specially ruled into graduated squares for the purpose of plotting curves.

Squirrel-Cage Rotor—One whose windings consist of a number of stout copper conductors interconnected at both ends by copper rings, the whole roughly resembling a Squirrel Cage. See Induction Motor.

S. R.—See Specific Resistance. A Silicon Steel composed of Iron.

Stalloy—A Silicon Steel composed of Iron, Silicon, Manganese Sulphur, Carbon and Phosphorus. The Iron and Silicon predominate.

Stand-Bi—A position of the tuner whereby waves of widely varying lengths are received. In operating, the expression is used to mean "Wait and listen," or "Don't interrupt." The International signal is QRX.

Standard Cell—Formerly the Clark Cell was used as the standard, but lately the Weston Cell has been accepted. See Weston Cell.

Starboard—Right side of a ship looking forward. Green light.

Star Grouping—A system of connecting up three phase windings. The circuits start from a common junction and their three ends go to three lines. Also called Y grouping.

Starter—A rheostat used for starting up a motor gradually. Usually fitted with a no-volt Release and sometimes with an Overload Release.

Static—Atmospheric disturbance.

Static Characteristic—A curve showing relationship between current of an arc and the potential drop of electrodes when their quantities are varied.

Static Charge—An electric charge at rest.

Static Electricity—See Electrostatics.

Static Induction—Effect of inducing a temporary electric charge in an electrified body by bringing near to it, but without contact, an electrified body. Transference without contact.

Static Leak—A coil of wire shunted across condenser in aerial circuit of tuner to allow weak atmospherics to escape "Leak to earth, instead of gradually charging up condenser. It is highly inductive, to prevent escape of required oscillations.

*This Dictionary was started in our March issue.

Junior Constructor

"SNAPPY" CONDENSER SCALES.

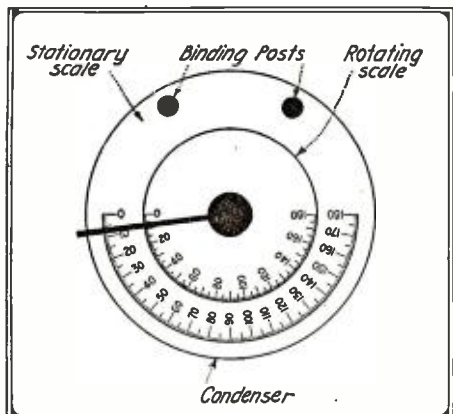

With This Scheme You Have an Expensive-Looking Condenser.

Here is an idea for you fellows who wish to have "snappy" condenser scales on your condenser. Secure some telephone transmitter diaphragms of which one side has a silvered finish. Now remove the knob and pointer from condenser. If diaphragms larger than 2½" in diameter are used they should be cut down to that dimension. Now enlarge the hole in the center of the diaphragm until it will slip on to the post on which the knob is then screwed back. It will be found that the numbers on the condenser scale just show under the new diaphragm-dial, which may be engraved to correspond with them. (The engraving may be done with a pen and ink or a pen and black enamel). If it is desired to make them still more "snappy" a hole can be drilled in the knob and a dowel about two inches long inserted in it, thus making the condenser easier to work and securing much finer tuning. It might be added that this scale also acts as a shield if connected properly in a C. W. hook-up.

Contributed by W. W. BRINKERHOFF.

A KICK-BACK PREVENTER.

Many amateurs are troubled by high frequency kick-backs and either do not know how to prevent them, or haven't the money to buy a high priced kick-back preventer. Here is one that will serve just as well as any high priced kick-back preventer. Buy two carbon lamps (you can get old carbon filament lamps for 15 to 20 cents each) and connect them as shown in the diagram. Whenever there is a kick-back the high frequency surge will go to the ground thru the lamps, thus saving your meter and fuses. If the lamps burn out the renewals are cheap, so there is no excuse for any amateur not having a kick-back preventer.

Contributed by

JERROLD SWANK (8ADD)

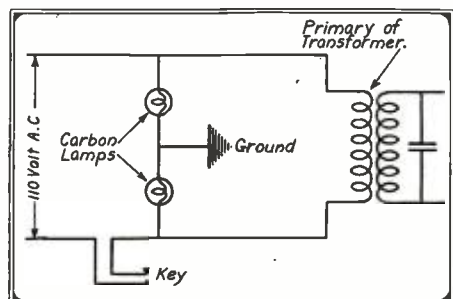

Two Old-Fashioned Carbon Filament 110-Volt Lamps May Serve as a Kick-Back Preventer.

ANOTHER HONEYCOMB COIL MOUNTING.

Sending in designs for honeycomb coil mountings seems to be a popular pastime with the amateurs, so will send in one I worked out. While I am modest, I don't mind saying it is much better than any I have tried. It works very well, is simple and easy to make and will stand a lot of hard usage. What more do you want?

The complete drawing in Fig. 1 should explain the construction. It will be noted that the binding of the coil proper is like that of the factory made article. The binder is best made of 1/32" fibre, but anything from linen to a strip of rubber collar may be used. The block "A" is made of hardwood, stained black, 1¼" long. It should be of the same thickness as the coil, and of various depths depending upon the size of coil it is used with. Piece "B" is of ¼" by ¼" fibre, drilled for the two wood screws "E", and drilled and tapped at each end for 6/32 or 8/32 round-head machine screws. The two leads from the coil are fastened under these screw heads.

Lower bearing bracket is of 1/16" by ½" brass or copper strip, of sufficient stiffness not to have any spring. Hole for lower bearing screw "D" should be large enough

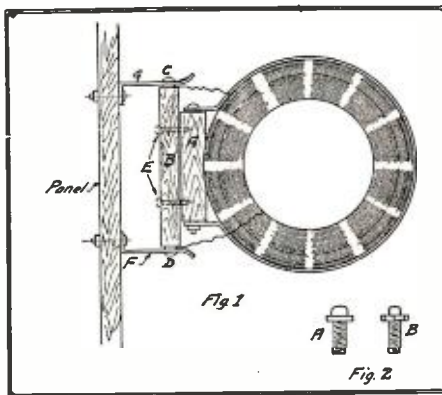

Much Better Than Any Other Mounting Long Has Used Before. He's Modest, Tho, That's the Short of it.

to fit well up over the screw head. A distance of ½" from the panel for this hole is about right. Upper bracket bearing has the same dimensions as the lower, but is made of fairly stiff phosphor bronze spring strip. It should be adjusted so that the coils swing easily, but are not too loose. For those using portable sets, subject to such hard usage that the coils might fall out, the bearing screws "C" and "D" should be altered as shown at "A," Fig. 2. Here the screw head has a shoulder filed on it as shown. The detail "B" in Fig. 2 may be used if preferred, and consists of a nut and short length of threaded rod. Fitted with either of these the coil will stand any amount of jarring without falling out, and may still be snapped in and out with ease.

I feel sure that anyone who will try this mounting will prefer it to many others. It should be noted that the factory made coil is easily adaptable to this arrangement. No fears need be entertained of noises due to poor contact. I have used it for two months with never so much as a click, even in the plate lead of a regenerative circuit.

Contributed by

L. LONG.

INSURING PROPER SLIDE CONTACT

While receiving signals one night I moved the slider slightly and weakened the signal some, and again it would some-

times increase the signal strength, so I arrived at the conclusion that the slider made poor contact with the rod. I then soldered a flexible piece of wire to the slider and binding posts, to which it was

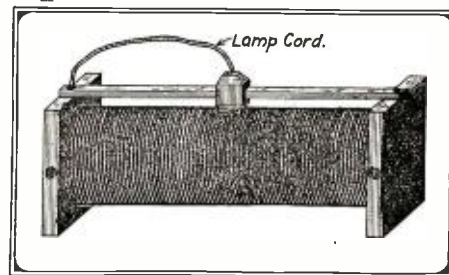

If You Are Using an Old Tuning Coil as a Loading Inductance Make Sure of Slide Contact.

connected, which resulted in an increase in efficiency. The scheme is outlined herewith. Contributed by WM. J. O'NEILL, JR.

A SIMPLE REGENERATIVE CIRCUIT

As the accompanying diagram indicates, all the apparatus required for this circuit is the following: a long wave tuning coil (or two honeycomb coils), one variable condenser, a crystal detector, a grid condenser and one audion bulb with the necessary batteries. The capacities, sizes, etc., of these instruments are of the standard type used by experimenters.

This circuit possesses some features which deserve special mention. It will be noted that the primary is connected to the grid and the secondary to the plate. As a result, regeneration is secured by the coupling between the primary and secondary, and no energy is lost in a separate tickler or feedback coil. The audion serves to maintain the oscillations in the circuit, and the crystal detector is used to rectify the signals. The effect is equivalent to one stage of amplification. The tuning is controlled almost entirely by varying the coupling and the variable condenser, for which reason this circuit is especially adapted for use with honeycomb coils. I use a Navy type tuning coil, which is bank wound according to the system described on page 623 of the May number of RADIO AMATEUR NEWS. My antenna is a small indoor one, consisting of four wires 50 feet long, with a 25-foot lead in. Using this equipment and the above described circuit, I have copied most of the Atlantic coast undamp't wave stations without amplification. I have also used this circuit on a small tuning coil for receiving 600 meter spark stations. Here I find it to give louder signals than either a crystal or audion detector alone.

Contributed by WILLARD H. FARR.

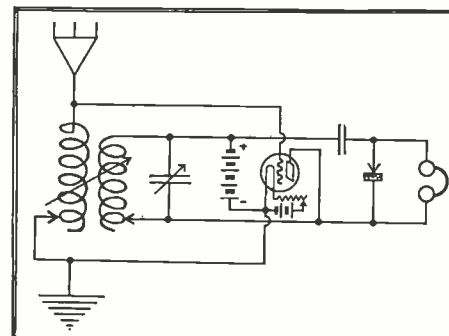

This Effective Circuit Has Given Mr. Farr Excellent Results at Minimum Cost.

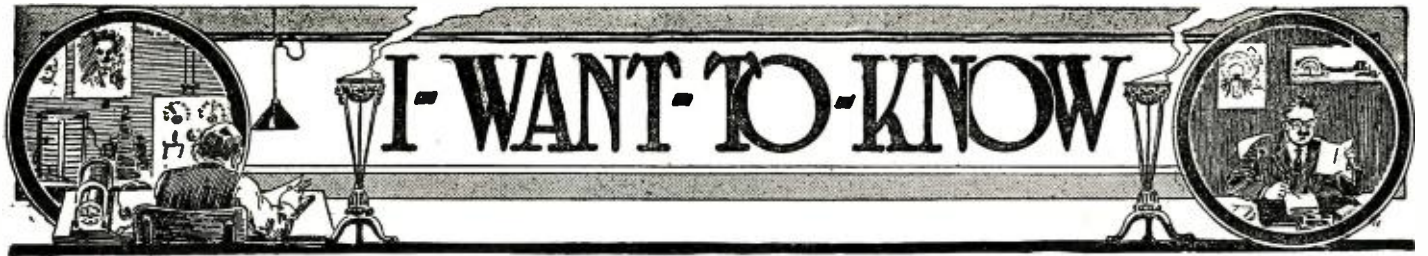

THIS Department is conducted for the benefit of our Radio Experimenter. We shall be glad to answer here questions for the benefit of all, but we can only publish such matter of sufficient interest to all.

1. This Department cannot answer more than three questions for each correspondent.
2. Only one side of the sheet should be written upon; all matter should be typewritten or else written in ink. No attention paid to penciled matter.
3. Sketches, diagrams, etc., must be on separate sheets. This Department does not answer questions by mail free of charge.
4. Our Editors will be glad to answer any letter at the rate of 25c for each question. If, however, questions entail considerable research work, intricate calculations, patent research, etc., a special charge will be made. Before we answer such questions, correspondents will be informed as to the price charge. You will do the Editor a personal favor if you make your letter as brief as possible.

ONE TUBE TRANSFORMER

(117) W. A. Simpson, Chicago, Ill., requests:

Q. 1. Please publish a suitable hook-up in the "I want to know" columns of RADIO NEWS whereby a single, vacuum tube is used in a radio phone circuit suitable for low wave lengths and employing, if possible, a small honeycomb coil instead of the regular inductance."

A. 1. A hook-up suitable for this method is shown on this page where the coil L-35 is employed as the antenna inductance and the variable condenser of .001 mfd. is used for the adjustment of the circuit.

TRANSFORMER-RECTIFIER FOR V.T. WORK

(118) Mr. Harold H. Okasaki, Los Angeles, Cal., asks:

Q. 1. Can small step-up transformer delivering voltages of 200, 300, 400, and 500 volts be used as a source of current for the radiophone circuit?

A. 1. Yes, this transformer can be used, in connection with two vacuum tube rectifiers to supply direct current to the plates of the bulbs.

Q. 2. With a small loose coupler, crystal deflector, fixed condenser, Murdock receiver, and an aerial 35 feet high and 30 feet long, can I receive about 300 miles or more?

A. 2. The aerial is too small for such a range, but under favorable conditions good results may be obtained. We suggest a 100 foot aerial.

USING A FAN MOTOR AS A PLATE GENERATOR

(119) Mr. Orris P. Bozman, Baltimore, Md., wishes to know:

Q. 1. Can a 250 volt fan motor running as a generator at a higher speed, delivering about 300 volts and having a commutator made of 20 segments be used for a radiophone with a filter circuit to cut out the ripple of the commutator?

A. 1. Certainly, you may use your generator to supply the current in the plate circuit of an undamped wave transmitter, but we do not believe the commutator has enough segments to give very good results for radiophone work.

Q. 2. Can the current be smoothed out so as to be suitable for that purpose?

A. 2. You can try two choke coils having an iron core 5/8" in diameter and 3 1/2" long, wound with two pounds of No. 26 double cotton covered wire and shunted by two, 1 microfarad fixed condensers for the purpose.

REDUCING NATURAL PERIOD OF AN AERIAL

(120) Mr. Clyde Stine, Eureka, Cal., wants to know:

Q. 1. In how many ways can the natural wavelength of an aerial be shortened.

A. 1. To shorten the natural wavelength of an aerial you can reduce the length of the wire or the number of wires, if it is a multiple wire aerial. Another convenient

way is to insert in series with the aerial one or several condensers, the proper amount to be found by experiment with a wave meter.

Q. 2. If so, how much may it be shortened?

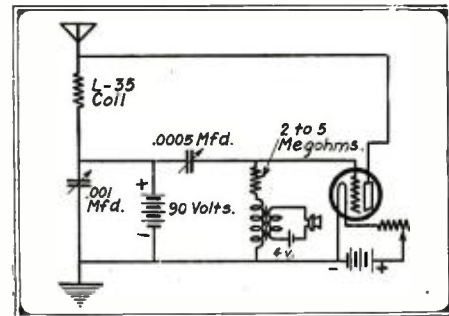

Q. 117. Single V.T. Phone Circuit for Amateur Experimental Work.

A. 2. It would not be advisable to shorten the natural wavelength of an aerial more than about 1/5 of its size for short waves and about 1/10 for long waves.

Q. 3. Is there any limit to the length or shortness of waves which an audion may detect or amplify?

A. 3. Yes, the shortness of wavelength that an audion can detect is limited by the value of inductance and capacity of the circuit. Practical audion circuits have been designed to operate on wavelengths as low as 25 meters and in some cases lower.

PARAGON CIRCUIT

(121) Francis S. Williams, Hornell, N. Y., asks:

Q. 1. What is the hook-up for the so-called Paragon receiver?

A. 1. You will find a general hook-up of the Paragon receiver on this page.

A 20,000 METER RECEIVER

(122) Mr. Latham Arnot, North Sidney, N. S. W., Australia, asks:

Q. 1. What are the details for the construction of a loose coupler for 20,000 meters?

A. 1. You will find in this issue under the title of "Effective 150-20,000 Meter Reception," information on the construction of such a receiver.

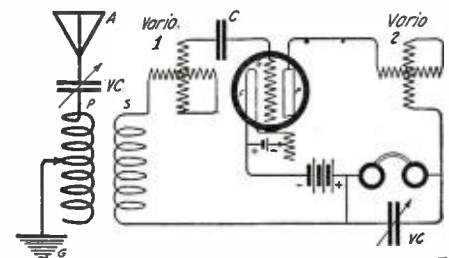

Q. 121. One Form of the Paragon Circuit.

ONE WIRE AERIALS

(123) Mr. James Dibler, Detroit, Mich., asks:

Q. 1. How high and how long should one wire be, to receive messages within a fair radius, effectively?

A. 1. Very good results can be obtained with a single wire aerial about 300 feet long and 50 feet high, or 425 feet long and 12 feet high. Very interesting experiments have also been carried out with long insulated wires simply lying on the ground.

Q. 2. Can honeycomb coils be used as a tuner to receive with a detector efficiently?

A. 2. The honeycomb or duo-lateral coils are the last word in inductance and you will obtain excellent results by the use of these bank wound coils.

BEGINNERS' BOOKS ON RADIO APPARATUS

(124) Mr. William M. Edwards, Johnstown, Pa., asks:

Q. 1. Can you tell me if there is an inexpensive book published telling how to make sending and receiving apparatus?

A. 1. Yes, the Experimenter Publishing Co., New York, has published two books on this subject, "How to Make Wireless Receiving Apparatus," and "How to Make Wireless Transmitting Apparatus." Price 35c. each.

REPAIRING VACUUM TUBES

(125) Mr. Milton Rose, Salisbury, N. C., asks:

Q. 1. Is there a firm repairing broken vacuum tubes?

A. 1. We suggest that you write to the Vacuum Tube Repair Co., 511 Perry Bldg Oakland, Cal.

REGISTERING RADIO MESSAGES

(126) Mr. Fred Williams, of Chicago, Ill., asks:

Q. 1. Is there an instrument which when connected to the receiving circuit will register the signals received?

A. 1. It is now possible to register the signals received by radio, by means of an amplifier and a sensitive relay, or with a loud talker which amplifies the sounds to such a volume that it is possible to record them on a phonograph record.

Q. 2. Where can such instruments be purchased?

A. 2. We suggest that you write to the Magnavox Co., 2701 E. 14th Street, Oakland, Cal.

ELECTION RETURNS BROADCAST

(127) Mr. Chas. O. Francis, Monongahela City, Pa., asks:

Q. 1. Will election returns be sent out by radio telegraph or radio phone?

A. 1. Election returns will be broadcast on each hour until midnight, November 2nd, at noon and 10 P. M., November 3d, 75th meridian time from Annapolis on 17,000 meters and from Arlington on 25,000 meters sparks. It will also be sent on fleet schedules. New York broadcasts on 9 P. M., on 3 A. M. 1,600 meters.

Another Fool Idea That Works

By ROBT. SELDEN ROSE

MY small boy has been taking the *Experimenter* and *RADIO NEWS* for some time and I bought him a receiving outfit which he promptly neglected to use as soon as the novelty wore off and of course the old man had to show him the possibilities of the outfit. The only help I had was from the back numbers of magazines and a fair grounding in electrical principles that every mining engineer is supposed to have.

Mr. Gernsback's editorials have been the direct incentive for some of my foolish experiments, for I recognized the fact that he is a man of imagination and my success in life has been due to trying to do that which the conservative said was impossible.

The enclosed sketch shows the details of my latest attempt at the apparently impossible and it certainly brings results.

My regular antenna is 180 feet long, V shape, 40 feet above the ground and 140 feet above Lake Superior. My receiver is direct coupled with one step of amplification. The telephones are Murdock 3000 ohms.

I have been greatly troubled with induction noises, discharge of power lines and intermittent interference from the welding of street railway bonding which has been going on for some time.

The following are the results from the use of the underground loop.

Induction efforts are absolutely eliminated. These while not very bad were enough to drown out very weak signals.

Street railway welding somewhat lessened, but this may be more apparent than real, owing to great increase in signal strength.

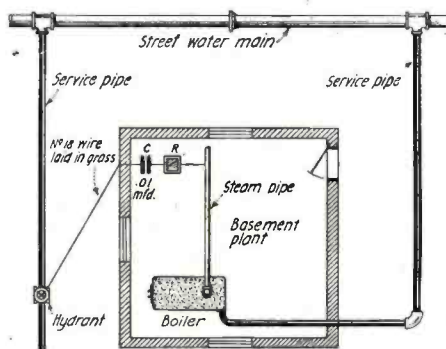

Say, Fellers, What Do You Think of this Underground Loop? A New Use for the Underground Pipes.

Signal strength increase is about equal to one step of amplification. Sayville, on antenna, is heard one foot from the phones. On the underground loop can be heard 20 feet away. Could never get time from Pearl Harbor on antenna although could

sometimes copy late at night. On loop have received the time whenever tried and can copy in daytime under favorable conditions. Can copy XDA any evening and sometimes without feedback. Always take NAA on straight spark, at night. Time from NAA, NSS, NAR, NBA, NAJ, NPM, NPL, NPG. Hear a faint spark station at 2800 meters, think may be Poldhu. Have identified nearly all the European stations and copy most all.

Am not sure of effect on static except that with loop and antenna hooked up together the static is increased with no increase in signal strength. Copied all the World Series broadcast from NAA, some days through bad street car welding interference and heavy static, thunder rumbling in the distance. Local static seems to be eliminated to some extent. Distant static very little.

Data on loop condenser. For wavelengths for 5,000 to 20,000, .010 m.f.

For wavelengths from 1,200 to 5,000, .0015 m.f.

For wavelengths from 600 to 1,200, .0005 m.f.

The more capacity in loop condenser the louder the signals, for that reason is not very satisfactory on short wavelengths, but may work out better on inductive coupling. Am also experimenting with sending buzzer sigs on this loop.

\$100 "PORTABLE RADIO" PRIZE CONTEST

WE again make the announcement of the third \$100 prize contest entitled "Smallest Portable Radio Outfit."

A great many amateurs,—if not the majority,—are intensely interested in a small portable outfit that can be taken about when visiting friends, when going away for week-end parties, for camping and a great many other purposes. Particularly during the summer and fall a good portable receiving outfit is greatly desired and highly prized, as we have been able to satisfy ourselves from experience.

With modern radio apparatus, properly put together, it is possible to receive messages over surprising distances, even with small, but compactly built, apparatus, and there is no reason why our amateurs should not be able to turn out something really worth while. In awarding prizes the judges will take into consideration not only the smallness of the outfit, but its efficiency as well. In other words, the first prize will not necessarily go to the amateur who builds the smallest outfit, but rather to the one who builds a small one that is efficient as well. Of course the word "small" as used here is rather elastic. In other words, the outfit which can be slipped into the pocket might be a smaller one, no larger than an ordinary watch! But, bear in mind, what we are after is not a freak outfit. A microscopic radio receiving outfit could no doubt be built, but we daresay, it would not be very efficient. We have recently seen a European outfit that was quite complete and could be carried around in a walking cane, and this was not a bad idea at all; besides it worked well. This may be a hint for some of our radio enthusiasts.

Requirements of the Outfit

THE outfit must have means for tuning. It may have one or more detectors. It should have means for receiving messages by sound, which may be the usual set of telephone receivers or something better.

There must, of course, be also an aerial of some sort as well as a "ground" or ground connection. Due to the very nature of the contest, it is of course necessary that the

aerial be such that it will not take up too much room nominally. Concentrated aerials of the loop type can be used, or any other contrivance that takes up a minimum space, but gives quite a good capacity when unfolded or extended.

Remember that the editors are not looking for freaks. The outfit must work and in order to prove it, the contestant must build it, for no entry will be considered, unless it is accompanied by a photograph of the actual outfit.

In publishing the various ideas, all the rights revert to the publishers. The latter also reserve themselves the right to publish manuscripts which were sent in to this con-

PRIZES OF \$100 IN GOLD

First Prize	\$50.00
Second Prize	25.00
Third Prize	15.00
Fourth Prize	10.00

test, altho they are not prize winning articles. In that case full space rates will be paid for any manuscript published that did not win a prize.

As will be noted, the publishers offer prizes totaling \$100.00 in gold for the best article on the smallest practical and efficient radio telegraph or telephone receiving outfits.

Several radio experts will act as judges in this contest. Every one of the judges will pass upon the manuscripts submitted, and there can be little doubt that all contestants will be treated fairly and impartially. From the very nature of the contest, we are certain that it will not only bring out the very best there is in the American amateur, but that it will advance the art for portable radio receiving outfits considerably.

Rules for the Prize Contest

THE set to be described may be of the usual receiving type. Vacuum tube type, or crystal detectors may be used at option of builder.

There should be some new features embodied in the outfit that are not known now, or have not been published heretofore. It is quite important, and as a matter of fact necessary that the set must have been actually built, that it is either in use, or has been in use. Wild "ideas" or patent descriptions are strictly excluded from this contest. It is also obvious that insofar as this contest is conducted chiefly to bring out NEW ideas, commercial radio outfits are excluded from this contest. It is necessary to state what instruments are used, and if some of the instruments have been bought, the make must be stated. A good diagram of the connections neatly executed in ink is to be furnished. A good photograph, not smaller than 5x7 inches giving at least two views of the set is necessary. A photograph of the builder is also required.

All photographs, diagrams and other data sent in by contestants which are not used will be returned at our cost.

In cases where there seems to be some doubt as to the practicability of the instrument we reserve the right to ask to inspect and test the set; insured parcel post charges at our own expense both ways. Of course, we shall return the instrument promptly. This, however, will not be requested if the photographs and descriptions are convincing.

More than one outfit may be entered by contestants. The contest is open to everyone, radio clubs included, except manufacturers. The manuscripts should not be longer than 1,500 words; 1,000 words preferred. Prizes will be paid upon publication.

The Contest closes in New York November 15th, and the first prize winning article will appear in the December, 1920, issue. Address all manuscripts, photos, etc., to "Editor Portable Radio Prize Contest," care of this publication.

A New Variable Condenser

THIS new product, a departure in former methods of condenser construction, of a Connecticut laboratory is a distinct improvement over the conventional instrument which is known as the rotary condenser, an instrument which is still in common use altho it differs in no way from the type originally employed when resonance circuits were first used.

The outstanding features of the new variable condenser are its compactness, which makes it a far more convenient instrument; its stability, which permits of securing adjustments, once obtained, from purely mechanical fluctuations; and its simplicity of design. Every essential requirement of a variable condenser has been fully met, and met in the least complex possible way. The result demonstrates the familiar saying that the "simplest way is the best way." For this new condenser is not merely more convenient and more stable; but it is far more sensitive, capable of much finer adjustments, permits a stronger signal, and establishes readings at both ends of the scale.

How these results are obtained is explained in the following manner which take up first the construction, then discussion of the operation, and the scientific reasons for the results obtained.

CONSTRUCTION.

Figure 1 illustrates the construction of the condenser. It consists essentially of two plates, B and D. B is fixed, and not only forms one plate of the condenser, but at the same time is a support for the entire unit. The plate D is free to move to and from B. The surface of B is covered by a thin washer of mica C, and the plate D has secured to its underside a block of insulating material which supports the guide rod and the screw. This guide is slotted at either end and passes over pins. This latter arrangement prevents the plate D from rotating when the nut is screwed down upon the shaft. A spring placed upon the screw operates to open the plates when the nut is unscrewed on the shaft. The variation of capacity, then, is obtained by merely screwing the nut upwards and downwards upon the shaft, which moves the plate D to and from B. The thread on this shaft is selected, however, so that the entire range of capacity is secured by one turn of the nut, altho the scale may be loosened and secured in some other preferred position.

COMPACTNESS.

This variable condenser is small, and compact, compared to some of the rather clumsy rotary type. The advantage of the small size on an instrument board is obvious.

The outside measurements of the condenser are $2\frac{7}{8}$ " in diameter and $1\frac{3}{8}$ " in height to the dial plate. The required capacity is obtained within this small volume by using an extremely thin dielectric. With the ordinary rotary variable condenser consisting of several sets of inter-meshing plates, the capacity seldom exceeds 700 micro farads. This same capacity is given in the condenser by two pieces of metal, each having an area of .17 square centimeters and separated by a sheet of mica .0012 centimeters (.0005") thick, assuming a dielectric constant of 6 for the mica. The rotary condenser would require a far greater area of conducting surfaces than this because the thickness of the dielectric, or the air space between the inter-meshing plates, must be sufficient to insure freedom

from short circuits between opposite plates. The condenser as was seen in Fig. 1, utilizes only two conducting surfaces, one of which is movable to and from the other, when close together by a thin disc of mica. but without rotation, and separated from each other when close together by a thin disc of mica.

NEGLECTIBLE RESISTANCE.

The condenser, because of its nearly per-



Photograph of This New and Unique Two-Plate Condenser.

fect dielectric and high insulating qualities, has an effective resistance of only a few tenths of an ohm. This is considerably lower than any other variable condenser now in use. High condenser resistance means a decrease, to a considerable degree, in the selectivity of the entire receiving circuit upon which it is used; and also a decrease of a great many times in the strength of signal received on the circuit.

In an alternating current circuit any condenser behaves as if it had a resistance in series with it. This imaginary resistance is commonly called the "effective resistance" of the condenser, and increases with the frequency of the alternating current. The magnitude of this effective resistance at any definite frequency depends upon several factors, but principally upon absorption in the insulating materials used in the construction of the condenser. Results of laboratory tests of the commercial type of variable condenser showed that their effective resistance varied between two and fifteen ohms. In the condenser with an effective resistance of about fifteen ohms, the signal strength on short waves would be less than one-tenth that which would have been received if a condenser with a resistance of 9.2 ohm had been employed.

EXTREME CAPACITIES OBTAINABLE.

The design of the condenser allows a very high capacity at the upper end of the scale, and a correspondingly low capacity

at the lower end. This capacity being distributed over a scale length of 360 degrees (one complete turn of the dial), as opposed to 180 degrees (or one-half turn of the dial) with the rotary types, has a smooth variation to the extreme end of the scale, a property which obviously cannot be shared by any rotary type condenser. This great range of capacity variation is due almost entirely to the mica washer when the plates are close together, and to the fact that its presence, when the plates are considerably separated, hardly affects the capacity. (The capacity will be inversely

equal to $\frac{M}{K} + A$, where M equals the thick-

ness of the mica, K the dielectric constant of the mica, and A the distance from the outer surface of the mica to the movable plate.)

HARMONICS OF WAVELENGTH

A simple radio circuit has a reactance equal to zero at a single frequency, namely, the resonance frequency, and the maximum current possible with the given unit will then flow. This result is strictly true only when the capacitance and inductance are concentrated at definite points of the circuit. In an antenna, however, the inductance and capacitance are distributed, and it is found that a maximum of current is obtained for a whole series of different frequencies or wavelengths.

What is called the "fundamental frequency" is the lowest frequency for which the current attains a maximum, when not loaded with either capacitance or inductance. Denoting this by f , there are in the same antenna other resonance frequencies, $3f$, $5f$, $7f$, etc., called the "harmonic frequencies" of the antenna. With the usual methods of producing current in an antenna it radiates principally waves of its fundamental frequency alone; free oscillations of the harmonic wavelengths are almost entirely lacking. However, when emfs. having the harmonic frequencies are applied, vigorous oscillations of those frequencies may be set up.

IMPEDANCE

The impedance of a telephone receiver to alternating current increases rapidly with frequency, and at radio frequency is so great as to permit practically no current to pass. By the use of detectors, however, the current that passes in the telephone consists of a series of pulses of audio frequency, usually from 500 to 1200 pulses or vibrations per second. A typical telephone receiver having a direct current impedance (resistance) of 200 ohms was found at 400 cycles per second to have an impedance of 2900 ohms, and at 800 cycles an impedance of 3900 ohms, rising to 4400 ohms at 1000 cycles per second.

BIDS ASKED FOR MEXICAN WIRELESS.

Particulars regarding proposed installation of new radio stations in Mexico at a cost of \$250,000 United States currency have been forwarded by Trade Commissioner Cunningham to the Department of Commerce, who states that bids from American companies for immediate equipment of this service are directed by the Director of Telegraphs of Mexico.

Radio stations of the following three kinds are to be installed in different parts of the Republic:

Those capable of communicating with the capital, equip with instruments of 10 kilowatts, those equip with instruments of five kilowatts, and those equip with instruments of two kilowatts.

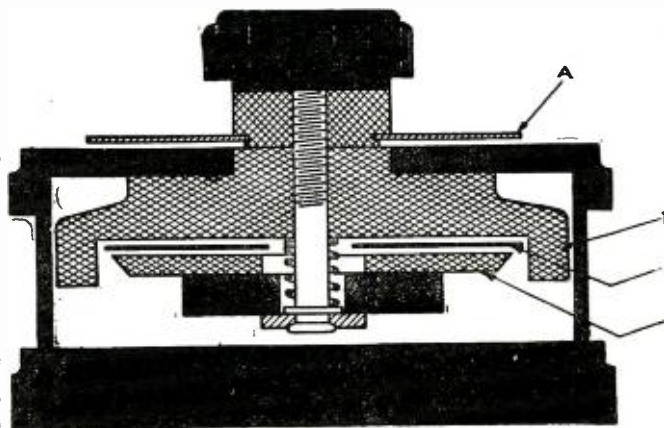

Fig. 1. This Illustration Shows the Internal Construction of the Condenser Which Consists of But Two Plates as Compared to the Familiar Multiple-Plate Instruments of Similar Capacities.

CORRESPONDENCE FROM READERS

CONCERNING OUR COVER ILLUSTRATIONS

Editor of RADIO NEWS:

In regard to your very excellent radio paper, why do you persistently offend our artistic sense with those outrageous cover pictures? When we buy a radio paper we are justified in expecting a collection of coldly scientific material, with an admissible human touch here and there, but why then inject the ridiculous? My comment upon the cover pictures is not in the nature of criticism of the artist, Mr. Howard Brown, for he is simply satisfying his customer, but rather an expression of bewilderment, and amazement that a paper of such genuine technical worth should admit such poor taste. Regarding the September issue: If the girl wants to learn radio, by all means let her, but in the name of the art why confuse oscillation and osculation? Frankly, I have heard radiomen express absolute disgust with such matter, and they have ceased taking the paper. I should suggest photographs of a RADIO interest for your cover pieces.

J. F. MAHER, Radio Instructor,
Knights of Columbus School,
Savannah, Ga.

[Every month we receive hundreds of letters, some bouquets, some brick-bats. Being of a modest trend of mind, we think it more advisable once in a while to print the brick-bats. As an answer to the above we might say:

When Mr. H. Gernsback first established the magazine he had an idea that radio was too technical and too unpopular a matter. He thought it would help the new art, and that it could not hurt it, if a little human interest was injected into a comparatively dry subject. As our readers probably have noticed, we print a purely technical cover one month and alternate it with a human interest cover. The underlying idea is to attract people, who would otherwise never come within the folds of radio, to at least pick up a copy of the magazine and leaf it over.

We know from experience that, due to our covers, we have made many thousands of new readers, not only boys, but men in all walks of life, who would perhaps not have come into the radio game otherwise. The very fact that RADIO NEWS has a circulation of close to 50,000 copies today, which is at least four times as large as its nearest competitor, shows that the principle is right. Of course, a cover alone does not make a magazine any more than a swallow makes the summer, and if the inside of the magazine were not of the very best, we naturally could not keep our readers.

In closing, we might say that not everybody wants to read dry matter all the time, and radio at best is rather dry. So anything that liven's it up, we think, will help the game along, and if we only attract ten thousand new readers a year by this method, we think we have accomplished our mission. Then too

*A little nonsense now and then
Is e'en enjoyed by radio men.*

We shall be glad to hear from our readers more along this subject, and will be glad to publish their letters from time to time.]

RADIOPHONE DATA WANTED

Editor of RADIO NEWS:

Your "Radio Concerts" in the September RADIO NEWS brings to mind something I have long been intending to say, as I think it applies to at least 75% of the radio amateurs.

I agree with you in every respect that radio telephony is THE thing and that the present spark system will soon find its way to the museum shelves.

There is one question which you must

ask yourself a hundred times a day. And that is: "I write about radio 'phones and offer prizes and publish articles, and yet why is it that there are so few radio telephones?"

Let me state my case and perhaps this will help you answer the burning question

What Have You to Say?

THE year is almost up and November brings fitful weather. The air is tart and pungent with the odor of nuts, red apples and leaves. We realize the summer is gone and we are making ready for those crispy winter nights when General Static has decamped for other climes.

THIS winter should see some marked improvements within the amateur station. At present, the amateur is planning as to just what changes he will make in his transmission and reception. Judging from past performances, it would seem that transmitter improvement will be the thing this winter. Many of us are equipt with efficient receiving units making possible top notch amplification.

HOW about a more general application of C. W. transmission? It is true that excellent work has been and is being done along this line, but there remains a great horde of amateurs who do not seem to have much faith in it.

JUST think of it! An oscillating vacuum tube circuit of proper constants and a high frequency buzzer to "chop up" the emitted continuous waves and you are at once on a plane with the more advanced experimenter. Not only that, but you secure better distance, a smaller expenditure of electrical power and the set is practically silent, compact and highly efficient.

FOR a given power a vacuum tube transmitting set gives something like 2½ times the range of a spark set. The tuning is also very much sharper providing of course the set is properly designed; consequently interference with other stations is greatly reduced.

THE editors of RADIO NEWS would like to hear from amateurs who have experimented with C. W. transmission and are particularly anxious to know of the success obtained as to distances, power used, etc. Better yet, let us have complete descriptions and data and if possible clear photographs of the units. You shall be paid for this material and at the same time you will be doing your fellow amateurs a good turn by giving us an opportunity to publish the information.

of the hour. I have a one-half kw. transmitting set using the spark system and am continually putting more money into it. when I have read articles on radio 'phone and prefer radio telephony to the telegraph method, yet I am not doing anything with it. The reason is simple.

There has not been enough written about BUILDING 'phone sets for me to form any plans. I can get fine hookups from Mr. Goldsmith's book and I can read about the results but I can't do anything because I have not found another amateur who has the specifications for the set I want to make. It is not that I want to build a wonderful set or anything like that, but that dozen or so articles I have been able to lay hands on I have not found what I or a hundred other fellows want.

The only remedy is to read a few good articles written by fellows who have actually built sets and used them long enough to realize what we don't know, so that he can write it up.

We don't want a photo of what it will look like so much as we want hookups, specifications, and last but not least explanations and hints on building it.

As an example I am sure that a number of fellows would pay a dollar a copy for any issue that told them the exact directions and specifications for building a set with about three or four bulbs, a buzzer, an induction coil and a number of switches so that the set could be used for radio 'phone, radio telegraph and receiving, using the same bulbs. Think it over and see if you don't agree with me.

Don't think I am ignorant of all you have done to help the unappreciative radio fraternity with radio telephony, for I have read your many articles helping and encouraging amateurs to make sets and send you a little article for which you will sign a check.

JOHN GORRELL,
1661 Thorn Street, Chicago Heights, Ill.

BOYS, GET THIS!

Editor of RADIO NEWS:

I have noticed with interest your editorial in the September issue of the RADIO NEWS entitled "Radio Concerts" and am sorry that rush or direct commercial work has prevented our posting you sooner on things which have been done in San Francisco.

You mentioned a concert inaugurated by the daily mail in London in conjunction with Madam Nellie Melba, transmitting voice and music which in some instances was heard over 1,000 miles away.

You mention later on a presidential candidate being invited to make a speech via radio and suggest the idea of broad-casting music from famous band masters.

Far be it from our desires to in any way detract from the remarkable results of the *Daily Mail's* efforts, but allow us to state that we have not only antedated but have more than paralleled the results you have set forth; likewise have been rendering effective the suggestions above cited for a period of over six months back.

The California Theatre, located at Fourth and Market Streets, San Francisco, is probably the largest and best equipped motion picture house on the coast and compares favorably with the Rialto, Capitol and other prominent theatres in New York which your readers are perhaps more familiar.

A De Forest oscillion radiophone transmitter has been installed in the California Theatre for over six months with the antenna strung to the top of the tower of the adjacent Humboldt Bank Building, and the music from the fifty-piece California Theatre orchestra, conducted by Mr. Herman Heller, likewise organ music by the famous C. Sharp Minor, has been broadcasted by radiophone every afternoon and every evening.

Prominent vocal artists who have been on the California program have also contributed to the radio transmission.

During the last Democratic National
(Continued on page 328)

MURDOCK No. 55

The Prices
Are Unus-
ually Low.

The Qual-
ity is Re-
markably
High.

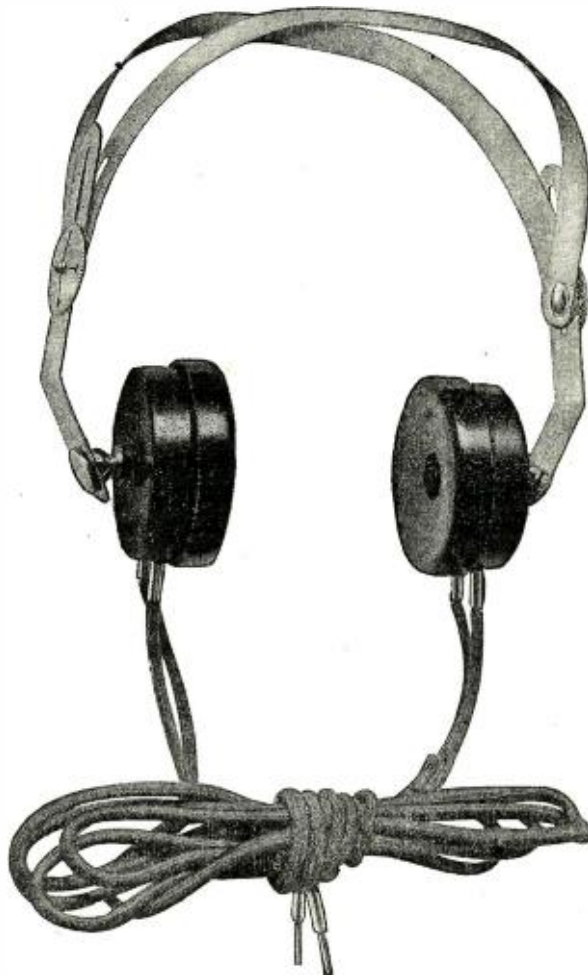

**2000
OHM
DOUBLE SET
\$4.50**

**3000
OHM
DOUBLE SET
\$5.50**

REAL RADIO RECEIVERS

backed by a liberal trial offer and an absolute money-back guarantee. No written argument in their favor can compare with the convincing proof of their actual performance. We simply urge a TRIAL, for we know that their sensitive operation will tell more surely than verbal claims, their exceptional value. Ask your dealer for them.

BULLETIN No. 20 will be sent on request.

WM. J. MURDOCK CO.

50 CARTER STREET
CHELSEA, 50, MASS.

509 MISSION STREET

SAN FRANCISCO, CALIF.

IF YOU ARE A
Government Licensed
Amateur Radio Operator

you should take pride in the fact. The great increase in the number of government licenses held means better radio in the future.

Show that you stand for
BETTER RADIO

by wearing one of the emblems illustrated below.



The emblem is exactly like above cut. It is constructed of 14-Karat gold plate with a blue enameled edge, producing a beautiful effect. A truly artistic button that you will be proud to wear.

Prices (Postpaid)

- Emblem coat button.....\$1.00
- 14-karat gold filled ring, 20 year guarantee..... 3.75
- 14-karat solid gold ring..... 9.50

Special prices to radio clubs when ordered in quantities.

Milton Specialty Co.

Two Offices:

Box 34, Columbus Ohio
Box 11, Philadelphia, Pa.

**Play the Hawaiian Guitar
Just Like the Hawaiians!**

Our method of teaching is so simple, plain and easy that you begin on a piece with your first lesson. In half an hour you can play it! We have reduced the necessary motions you learn to only four—and you acquire these in a few minutes. Then it is only a matter of practice to acquire the weird, fascinating tremolos, staccatos, slurs, and other effects that make this instrument so delightful.

The Hawaiian Guitar plays any kind of music, both the melody and the accompaniment. Your tuition fee includes a beautiful Hawaiian Guitar, all the necessary picks and steel bar and 52 complete lessons and pieces of music.



**Send Coupon NOW
Get Full Particulars FREE**

First Hawaiian Conservatory of Music, Inc.
233 Broadway NEW YORK

I am interested in the HAWAIIAN GUITAR. Please send complete information, special price offer, etc., etc.

NAME

ADDRESS

TOWN

STATE R.N.
Please write name and address clearly.

You can be quickly cured, if you
STAMMER
Send 10 cents coin or stamps for 70-page book on Stammering and Stuttering, "Its Cause and Cure." It tells how I cured myself after stammering for 20 years.
Benjamin N. Boguo, 864 Boguo Bldg., Indianapolis

What are You Going to Do About It?
Do not Read This Unless You Have the Uplift of Professional Radio at Heart

By **ARTHUR H. LYNCH**

WE all know that it is not so many years ago when a fellow could go to sea without any license and most of us remember the ups and downs of the old days, when it was very problematical whether or not there would be any salary forthcoming at the end of our voyage. It is a hard thing to say whether or not the company which employed us at that time committed financial suicide, but at any rate, they are no longer in business, and it is our desire to know just where we stand under the present scheme of things.

It may be well to pause for a minute to look over just what we have in the line of security and from that draw some sort of plan for what we must have in the future if Radio is going to hold anything for us and for the steamship companies for whom we are supposed to work.

Let us first take into consideration the "Certificate of Skill" which was issued for a period of about one year prior to the adoption by the Department of Commerce of the present system of licensing. The examination a man had to go thru for a "Certificate of Skill" really examined him for that skill. It generally took several days to complete it and it covered the whole field as the field was in those days. Unless a fellow could really hook up and operate a station he could not get thru. In addition to the ordinary handling of the various systems upon which a man's worth was judged there were times when the examiners put in a few little kinks of their own to help the thing along, such as breaking the telephone leads, short-circuiting the receiving coil and supplying fake fuses. Needless to say, unless a man was on the job he flunked.

Frankly and truthfully, how many of the present-day professionals could pass such an examination today? From what I have seen of the game, there are very few in comparison to the number of men holding licenses. Fellows, it is up to us to get wise to ourselves. It is true that this will meet with disfavor by some who, by the grace of God and a favorable wind sailed thru the examinations during the war and landed licenses and know deep down in their hearts that they don't even know the difference between a dynamo and a motor. And let me say right here that there are a great many men of this type sailing the seven seas. If this business is to be worthwhile, it is necessary for us to do everything in our power to make it so, and the first thing we have to do is to make sure that we are handling our traffic in a manner which will make it easy for every one else to work. Just to cite an instance of what I mean, let me enumerate what happened on the afternoon of Sunday, August 1st, right in New York harbor, where we should expect to find the best of operating conditions. A tank steamer was called by one of the local stations and replied to the call and was copying some instructions from the land station when another land station opened up and called him (the tanker). The second land station's spark must have been the louder and it was to this station that the tanker answered. From the method of calling and the formation of his characters it was evident that the tank man was new at the game, but the land station shot a rather long message thru to him at not less than twenty-five, and nearer twenty-eight, words a minute. The usual "2RM" was the reply. After calling the tanker eleven times and signing off seven times (by actual count), the land station went ahead again, with the same luck. He went at it the third time.

after calling as many times as before and throwing in a few extra signals and shot the message the third time, when lo and behold he was finally given an "O.K." There is no way of my checking it up, but I'd bet a red apple the fellow on the tanker made a pretty mess of that message.

All those long calls could have been eliminated if the man at the coast station had had sense enough to realize that he could have permitted the man on the tanker to make a perfect copy if he had cut down on his speed and given the fellow a chance, but he was evidently a "high speed" artist and his sending was not really bad. This happened about four o'clock in the afternoon and I hope the fellow will have the good fortune to read this and be guided accordingly. The fellow on the tank was obviously not very clever at receiving, but he knew the proper method of procedure, and USED IT, while the other man probably knew it but thought it was intended for the "lids." He, of the two, was the greater lid. Alas! this sort of thing is going on all the time.

Just let us take a look at the list of licenses, as they are today.

From a perusal of these it will be seen that the only one which requires a man to have had any previous knowledge and service of Radio is the Commercial (Extra First) License. This brings about a condition with which we are all but too familiar, namely: the man just coming out of school and who skids thru the superficial present-day examination is qualified in the eyes of the law to hold any Radio position he can force himself into. This is a serious matter which has evidently past most of us as something which was entirely necessary and which could not be changed. Such is not the case.

When a delegation of Association men placed the matter before the Department of Commerce at the recent conference in Washington, they were advised to draw up what they thought to be an equitable system of license graduation and every effort is now being bent in that direction, with the assurance of the Department that it will do everything in its power to change present conditions.

If the installations over which we have charge are to deliver the goods we have to know how to manipulate them properly. If the installations don't deliver the goods it is a pretty certain fact that our profession will never get the recognition it should. Provided with good sets, such as we find on most of the ships at present, there is no reason why traffic should not be handled a great deal better than it is at present.

Granting that the present method of granting licenses is far from being what it should be, the only way for a revised system to be of any use is in conjunction with the grading of the stations upon which future licenses will be valid. The trouble is not so much the grading of licenses as it is the grading of the ships and coast stations. Under the present conditions it is possible for a man just breaking into the game to be placed on a ship as senior to a man holding an Extra First Grade License, which is obviously unfair.

We can not expect our employers to favor salary increases when they can point to us as a whole and tell us we are not capable of carrying out our jobs properly. If a man is not capable of carrying out traffic in the proper manner and is not familiar with the adjustment and maintenance of his equip-

(Continued on page 326)



The Big Store on the Corner

IT'S SATISFACTION— TO KNOW

That your goods are *SHIPPED THE SAME DAY* that your order is received here.

A \$12,000 RETAIL STOCK!
A \$20,000 JOBBER'S STOCK!

is here at all times to supply your wants.

We are Authorized Distributors for
DEFORREST RADIO TEL. & TEL. CO.

WM. J. MURDOCK CO.

AMRAD PRODUCTS

We also carry a representative stock of the Clapp-Eastham Co., Perfection Radio Co., Thordarson transformers, Acme Apparatus Co., Chelsea Radio Co., Federal Telegraph Co., Regenerative receivers, and Duo-Lateral Inductances, and General Radi Meters. Also a complete line of Radiophone transmitters and parts. We have every style head set for immediate delivery.

MATERIALS AND PARTS

A-18	Large Nickered Binding Post\$.20
A-19	Large Brass Binding Posts18
A-20	Medium Nickered Binding Posts15
A-21	Hard Rubber Condenser Knobs16
A-22	Bakelite 1½-inch Knobs18
A-23	Bakelite 1-inch Knobs14
A-24	Set of Rotary Gap Electrodes, per pair 2.00
A-25	Small Nickered Binding Post15
A-26	Battery Binding Posts04
A-27	Helix Clips05
A-28	Nickered Pointer04
A-29	Nickered Pointer05
A-30	Variable Grid Leak75
A-31	Hard Rubber Key Knob20
A-32	Nickered Thumb-screw10
A-33	Standard Telephone Jack 1.20
A-34	Standard Telephone Plug 1.20
A-35	Phosphor Bronze Switch72
A-36	Metal Shielded Grid Condenser 1.00
A-37	1½-inch Switch Arm and Knob60
A-38	Special Removal End Plug 2.00
A-39	Special Wireless Jack 1.00

SPECIALTIES

A-1	Saw-tooth Machined Rotor, for rotary gap\$4.50
A-2	Standards, Base, and Electrodes 2.50
A-3	Electrode Ball Insulator40
A-4	Rubber Goose-neck VT Socket 2.75
A-5	Acme Amplifying Transformer 7.00
A-6	Paragon Reversible Rheostat 1.75
A-7	Hard Rubber Condenser Dial 1.30
A-8	Nickel-plated Condenser Scale30
A-9	Unmounted Amplifying Transformer 4.50
A-10	Single Pull Battery Switch36

Introductory OFFER

The "Big Midget" Audion cabinet, actual size 6¼" x 3½" x 2", complete with oak cabinet, VT socket, condenser, grid leak and Paragon rheostat, assembled and wired.

AUDION DECTOR \$12.50
without bulb or battery

UNIT SECTIONAL CABINET RECEIVER

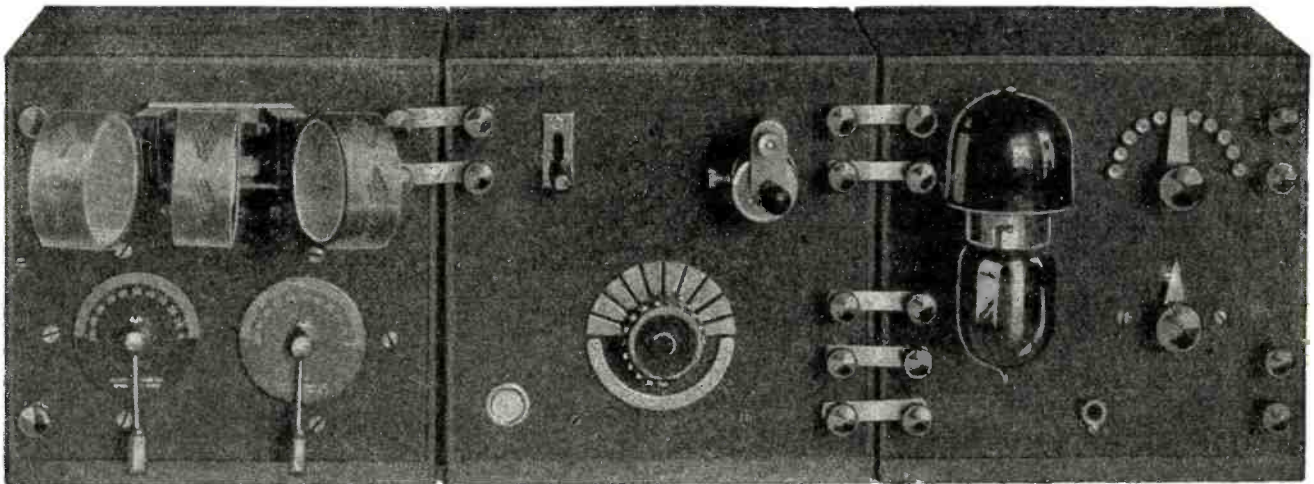

YM-7b

YM-9

YM-4e

A typical unit sectional cabinet receiver of which we are the sole originators and designers. Cabinets of quarter sawed oak, "Early English" finish. Bakelite panels. Audion cabinet contains 60 volt variable "B" battery. This set with proper honeycomb coils is operative over a wave length of from 150 to 20,000 meters. Amplifiers may be added to this in any number. The crystal detector cabinet includes enclosed buzzer and battery. All instruments can be supplied separately or in complete sets.

Tuners

- YM-7b—With plain mount..\$29.50
- YM-7a—With gear mount... 32.50
(less coils)

Crystal Detector

- YM-9—Complete with test buzzer and battery.....\$24.50

Detectors—Amplifiers

- YM-4e—Complete—det.\$25.00
- YM-5e—Complete ampli..... 31.00
(less bulbs)

Send for 55 page
Catalog. 4c stamp



Manufacturers,
Jobbers, Retailers

The History of the Honeycomb Coil

By ROBERT F. GOWEN *

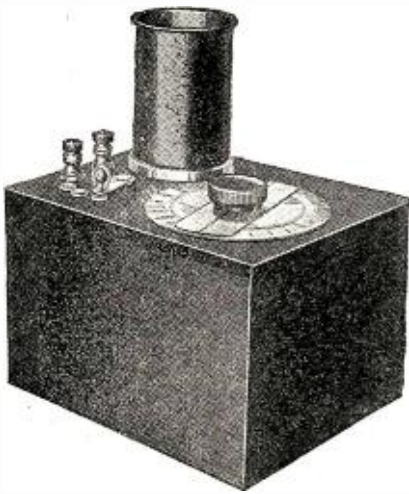

Doolittle Decremeter

A superior Wavemeter and a Decremeter in one instrument. Will enable you to adjust your transmitter to the legal requirements and increase the range of your transmitter.

Price - - - - - \$25.00

Shipping Weight 4 lbs.

F. M. DOOLITTLE CO.

157 Valley Street New Haven, Conn.

What a Dime Will bring You From the Nation's Capital

The little matter of 10 cts. will bring you the Pathfinder eight weeks on trial. The Pathfinder is an illustrated weekly, published at the Nation's center, for all the Nation; an independent home paper that prints all the news of the world and tells the truth; now in its 28th year. This paper fills the bill without emptying the purse; it costs but \$1 a year. If you want to keep posted on what is going on in the world, at the least expense of time or money, this is your means. If you want a paper in your home which is sincere, reliable, entertaining, wholesome, the Pathfinder is yours. If you would appreciate a paper which puts everything clearly, strongly, briefly—here it is. Send 10c to show that you might like such a paper, and we will send the Pathfinder on probation eight weeks. The 10c does not repay us, but we are glad to invest in new friends. Address: THE PATHFINDER, 494 Langdon St., Washington, D. C.

Washington has become the World's Capital and reading the Pathfinder is like sitting in the inner council with those who mold the world's destiny.

Chicago Painting School

The only school in the U. S. teaching by actual application.
Sign Painting, Show Card Writing, Paperhanging, Marbling-Graining, Decorating, Auto Painting, Short Term—Low Cost—Catalogue FREE.
CHICAGO PAINTING SCHOOL,
150 W. Austin Ave. Chicago, Ill.

RADIO CLUB PINS

Special folder of designs and prices in addition to regular school pin and ring catalog free on request. Be sure to see these new numbers which will put new life in your club
Metal Arts Co., Dept. 11, Rochester, N. Y.



TELEGRAPHY

(Both Morse and Wireless) and RAILWAY ACCOUNTING taught thoroughly and quickly. Big salaries now paid. Great opportunities for advancement. Oldest and largest school; established 46 years. Endorsed by Telegraph, Railway, Radio, and Government officials. Expenses low—opportunities to earn large portion. Catalog free.

DODGE'S INSTITUTE D Street, Valparaiso, Ind.

WIRELESS TELEGRAPHY

Make your own "Wireless," also Dynamoe, Batteries, Motors, Telegraph, Telephone, Lights, Bells, Alarms, Coils, Current Reverser, Electric Engines, etc. Book with 75 illustrations; by experts so anyone can understand it. With Catalog, All 10c, 3 for 25c pp

J. C. DORN

705 S. Dearborn St., Dept. 21, Chicago

READ LOCOMA

—an interesting, instructive MAGAZINE, on personal subjects, such as Love, Marriage, Divorce, Eugenics, Birth Control, Sex Hygiene, etc. For Men and Women only. 15 cents a copy, \$1.50 a year, 8 months' special trial 50c.



Editor's Note: Since many previous articles in radio publications credit Mr. Gowen with the invention of this new and revolutionary type of radio inductance, the author submits the following article in response to the many questions which have arisen in the minds of our readers since the publication of our article on the history of the Duolateral coil. This article appeared in our June issue, and in it Mr. Thomas Giblin of the Electrical Products Company claims priority of invention of the Honeycomb coil.

The development of the Honeycomb coil really dates back to the birth of the Unit Set, which idea came to me about the first of November, 1918, or two months before I asked Mr. Giblin, of Providence, R. I., if he could wind the coils for me. In designing the Unit Set, it was necessary for me to use coils of the pancake type that could readily be interchanged and could be mounted in a flexible manner so that the coil mounting or "loose coupler" unit could be used with any one of the many other units embodied in the idea. It therefore occurred to me at this time that cross-wound self supporting coils (which were made by the Coto Coil Company of which Mr. Giblin was Manager), if expanded to provide air spaces between the turns, would be ideal for the purpose. This development would not only constitute coils of the mechanical design I needed, but would, no doubt, produce a coil of extremely low distributed capacity and other desirable characteristics.

This expansion of the cross-wound coil idea had been in my mind since the summer of 1917, at which time I mentioned it to several of my friends including Mr. Giblin. As it was impractical to wind large diameter expanded cross-wound coils in heavy Litz, I suggested to the latter gentleman the advisability of winding cross-wound coils of standard Navy 3-16-38 Litz for use as long wave radio frequency inductances. Previous to this time the cross-wound coil had never been used for radio purposes. They were made to be used as transformers and spark coil pies. The idea of winding radio frequency inductances in this way had never occurred to Mr. Giblin and the Coto Coil Company, as they had not entered the radio field in any way and were concentrating in making up quantities of their transformer "pies" for the Government.

Acting under my specification, Mr. Giblin therefore wound up some sample Navy Litz inductances for me with the result that the De Forest Company had the Coto Coil Company make up several hundred for use in some Navy long wave receivers the De Forest Company were building at that time. To my knowledge these were the first radio inductances that were ever wound by the Coto Coil Company. These receivers were reported to be the most successful the Navy had received and Mr. Giblin therefore advertised the cross-wound radio frequency inductances and thereafter sold quantities of them. This evidence is introduced to show that the Coto Coil Company and hence Mr. Giblin, who shaped its policy, were not interested in radio windings until after this time. It also shows that Mr. Giblin at that time and for some time thereafter did not appreciate the value of the cross wind as a means of diminishing distributed capacity in radio coils or otherwise he would no doubt have wound these radio frequency inductances of his own initiative. This is no reflection on Mr. Giblin, who has always been and still is a good friend of the writer's, since Mr. Giblin never has

claimed to be a radio engineer who is interested in such problems. However, shortly after he was shown the value of cross-wound Litz coils, he erected a small amateur radio station at his home for the purpose of testing them out.

In November, 1918, I showed my idea for the Unit Set with the Honeycomb Coils, to a friend who heartily approved it and afterwards I took it to the De Forest Company, who refused to be interested. The matter was then dropped until in January, 1919, when the De Forest Company decided to enter the amateur field again, at which time my plans were approved, and I went to the Coto Coil Company, Providence, to develop the coil for the Unit Set. I first had Mr. Giblin wind cross-wound coils of certain dimensions, of which I measured the inductances with a wavemeter I had brought with me. This preliminary work was done to ascertain roughly the inductance of this cross type of winding for a coil of the given mechanical dimensions and size of wire. From this data I was able to estimate roughly the number of turns that would be required in a Honeycomb type of winding for the same inductance. After these estimates had been made I asked Mr. Giblin if he could not change the cam on his machine to produce an open wind of the cross wind coils. He did not understand what I meant at first, but got my idea shortly and brought from a show case a coil wound exactly like a ball of Corticelli silk and about the same size and shape, asking me if that was what I meant. This is the coil referred to in a recent article as the "basket wound" coil which was made, it is claimed, when the machine was being developed to wind wire. Mr. Giblin told me that they had wound a number of the "basket wound" coils for a large concern who used them as resistance or heater coils, as the open winding caused good heat dissipation. I wish to point out here that these "basket wound" coils which are referred to also as "Honeycombs" are not and were not Honeycomb coils in any sense, since they were not designed and were never used for radio purposes. Moreover, they were of a very different shape mechanically so that as radio frequency inductances to be coupled together, they were entirely out of the question. The name "Honeycomb" coil is a trade name which was given to a radio frequency type of inductance and which was designed by me specifically for radio purposes; the first samples of which were made by Mr. Giblin on a machine of the Coto Coil Company.

I stayed with Mr. Giblin for two days working towards getting what I called a "true" Honeycomb wind. Mr. Giblin worked the machine and I measured the coils as he produced them and suggested changes in the mechanical wind. It was found comparatively easy to get the machine to produce coils of the Duo-Lateral type, but it took two full days before we were able to get the machine to deliver a true Honeycomb. Lack of time and apparatus prevented my ascertaining the distributed capacity values of the coils at this time and hence the coils were not measured properly until my return to the De Forest Company. I knew at this time that the electrical constants of the Duo-Lateral coils would be as good as those of the true Honeycomb, since it was apparent that a distance equal to the diameter of the wire between turns was sufficient to give a minimum distributed capacity value.

If Mr. Giblin claims priority on the invention of this coil for radio use by about

(Continued on page 325)

*Designing Engineer, De Forest Radio Tel. &



S O S again Captain - Clear as a Bell

Faintly the call of a disabled passenger liner reached the wireless room of the destroyer Falcon. A report to the bridge brought the captain rushing into the wireless room to get first hand news. Operator Nelson clamped his faithful Baldy phones tightly over his ears and waited breathlessly for a repeat.

"S O S again Captain," he exclaimed, "Clear as a Bell." Position of the sinking ship was quickly obtained and the captain's hurried command started the destroyer plowing through the seas at thirty knots to lend timely aid to the disabled liner.

Baldwin Phones made good for operator Nelson. They have been making good for the U. S. Navy, the British, French and other foreign governments. The professionals all over the world choose Baldy Phones because their experience has proven them to be most sensitive.

From a standpoint of value received, Baldwin Phones are low priced. You obtain the equivalent of two mica diafram phonograph reproducers—two electro-magnetic amplifying mechanisms of the famous Baldwin design, in addition to the accessories.

Ask your dealer for a copy of our new Baldwin Catalog B1. If he can not supply you write us direct.

JOHN FIRTH & CO., Inc.

18 BROADWAY

NEW YORK

Agents for

Eldridge Measuring Instruments

Kolster Decremeter

U. S. Bureau of Standards Wavemeter

BALDY **FOR LAND SEA AND IN THE AIR** **PHONES**

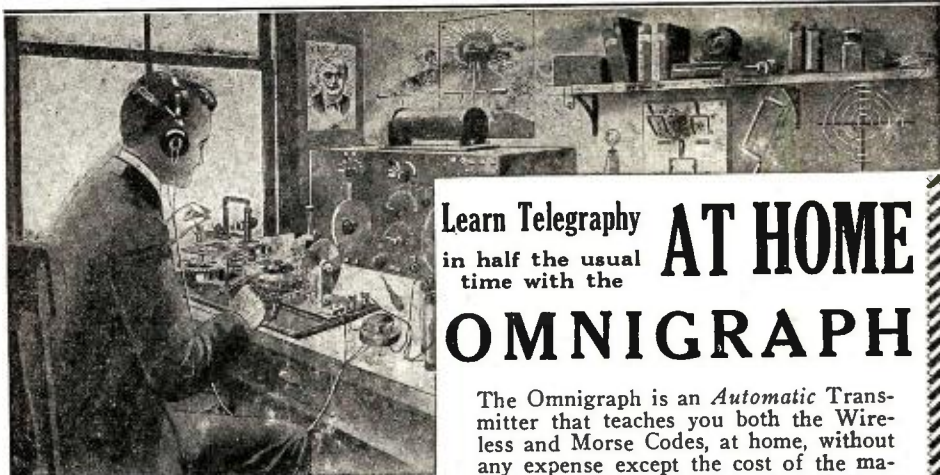

Learn Telegraphy **AT HOME**
in half the usual time with the **OMNIGRAPH**

The Omnigraph is an *Automatic Transmitter* that teaches you both the Wireless and Morse Codes, at home, without any expense except the cost of the machine itself. Merely connect to battery and your Buzzer, or Buzzer and Head Phones, or to your Sounder and the Omnigraph will send unlimited messages by the hour, at any speed you desire.

Just Listen—The Omnigraph will do the teaching

For a few dollars you can have a complete outfit that will make you an experienced operator in the shortest possible time. No hard, laborious work—just learn by listening. The Omnigraph is adjustable so you can start receiving messages slowly, gradually increasing the speed as you become proficient.

You'll be surprised how quickly you will attain speed. Even if you are already an operator the Omnigraph will help you. It will make you more proficient, more accurate and more confident. Thousands of Omnigraphs are in use today and thousands of operators owe their success to them.

Write for Free Catalog

Send for a catalog today, showing the 3 different models, \$14.00 to \$30.00. Every Omnigraph is sold with the absolute guarantee that you must be satisfied or your money back for the asking. Send for Booklet today—it will come to you by return mail.

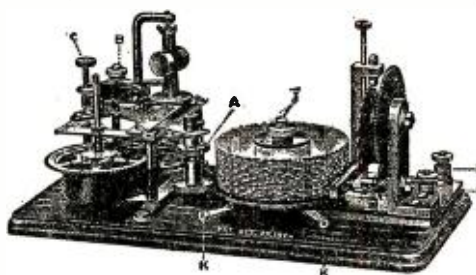

The Omnigraph Mfg. Co.
26 F Cortlandt St., New York City

The Invisible Radio Pilot

(Continued from page 272)

normally leaves one-half of the channel clear for vessels going the opposite direction. Any slight departure from the immediate locality of the cable will be immediately indicated by a decrease of signal strength in ample time to correct the course and assume the former position.

The maximum space required for the installation of the receiving equipment is 2 cubic feet, exclusive of the coils, which may be portable, being placed over the ship side when required. The electrical connection may be made by means of a water tight plug and receptacle similar to that used in connection with the ship's running lights.

A VISUAL SYSTEM

There is no reason why the present system cannot be improved in the very near future, where instead of gauging the distance by the oral method, that is, employing the customary telephone receivers, a *visual* system can be installed. In this case the receiving apparatus would be the same, employing a detector and several stages of amplification, but where the resultant energy would be sufficient to operate a sensitive relay causing a registering needle to move along a piece of tape and register which side of the cable the vessel happens to be. This can be done by placing a line in the center of the tape and devising an accurate arrangement so that the needle moves according to the maximum energy picked up by either the port or starboard coil, thereby obtaining a graphic and permanent record of the course taken by the ship when guided by the cable.

IMMEDIATE PLANS

Extensive plans are now being made to considerably extend the usefulness of the induction cable. In the case of New York Harbor, the Navy department has ordered the cable to be extended a considerable distance into the deep water of the ocean. Not only that, but other cables are to be laid along the Long Island Coast as well as the Long Island Sound. Additional cables will also be laid in the immediate neighborhood of Fire Island Light House, Shinnecock Light House, and Montauk Point Light House so that should any vessel approach these light houses too closely during fog, the induction cable will warn them.

The frequency of these planned cables will remain the same, in fact it has been agreed to adopt 500 cycles all over the world. The matter of being able to recognize various points will lie in the characters transmitted by individual cables using the dot and dash system. In other words the same system will be applied to these cables as is now being used for light houses—various flashes being easily recognizable by mariners.

There is one thing certain, the induction cable will lend itself admirably well suited to general navigation in connection with the present day system of radio compasses which have proven so satisfactory and which have been of such assistance to vessels nearing port. The two will make themselves quite useful in that the radio compass will first guide vessels to harbor approaches during fog and after once having reached these approaches will be able to pick up the cable and from that time on be guided exclusively by the latter until the vessel has reached its allotted pier or dock. In this manner the two systems will co-operate with each other and work hand in hand so to speak.—Another achievement for radio!

Dependable Radio Apparatus A new Tuner and a new Short Wave Set have joined the **DEPENDABLE FAMILY**
Catalogue Mailed for 10 Cents in Stamps
DORON BROTHERS ELECTRICAL COMPANY
Hamilton, Ohio.

The Symbol of Excellence
(This trade mark stamped on all R. I. Co. apparatus)

Bakelite V T Receptacle



Made from highest grade Bakelite-Dilecto and nickel plated phosphor bronze. Quickly adaptable to any form of mounting. Double and triple units may be dismantled and used singly.
Single \$1.00; Double \$2.00; Triple \$3.00.

6 Step Grid Leak
(Sealed in Bakelite)



Are you using correct value of resistance for your grid leak? This is necessary for efficient operation. 1/4, 1, 1 1/2, 2, 3, 3 1/2 meg ohms in single unit. 6 Step \$1.50; 3 Step \$1.00; Single Grid Leak any size, 50c. Grid Mica Condenser separately or on same base with grid leak 50c. 10,000 to 100,000 ohm units for resistance coupled amplifiers and experimental work 85c.

RADIO INSTRUMENT CO.
Hutchins Bldg., Washington, D. C.

Materials and Parts
for that new set you are building, we have it.

Brass sheet, round and square rods, sheet aluminum, fibre, bakelite and hard rubber cut to size, machine and wood screws, binding points, switch points, knobs, insulators, switches, all types; variable and fixed condensers, and card board tubing. Murdock, Acme, Tresco, Bunnell, Parkin, Morehead and Burgess products in stock, and we can give you the service you want. Our new catalogue sent for five cents, which will be refunded on first order for one dollar or over.

Try us on your next order

Keystone Radio Co.
Drawer 307 - Greenville, Pa.

Radio-Co-operation of Radisco Instruments

Did you ever stop to consider the "Radio-Co-operation" of the instruments you buy? How do they co-operate and conform with each other, when they are hooked up in your station? Do you get the strength of signal that only comes from apparatus "that works in harmony?"

RADISCO apparatus does just that; every single instrument turned out by Radisco

Engineers is a piece of master craftsmanship which must be subjected to the most rigid scrutiny of laboratory censorship known; and not a single article is marketed until it is proven by actual tests to work in harmony with the other Radisco instruments of quality in "Radio-Co-operation."

The latest triumph to be released from the Radisco Laboratories is the

Radisco Coupler

Specially designed for use with the No. 1 Variometer

The stationary winding consists of 37 turns in groups of six turn and single turns. Strength and high insulation insured by use of Bakelite tubing. Brass bearings support thoroughly seasoned wooden ball; Brass shaft of standard size to fit the No. 67 Corwin dial projects far enough for Coupler to be readily mounted. The whole instrument is finished off on a neatly varnished wooden base.

No. 2 Coupler, (as illustrated), - - \$8.50

No. 2D Coupler, (with dial), - - 9.75

Shipping weight 3 pounds



The agents listed below carry all Radisco products and they will be glad to consult with you on the new Radisco Coupler

ALBANY, N. Y.
Shotton Radio Mfg. Co.,
8 Market St.

ASHEVILLE, N. C.
Hi-Grade Wireless Instrument
Co.

BALTIMORE, MD.
Radio Engineering Co.,
614 No. Calvert St.

BEINVILLE, QUEBEC, CAN.
Canadian Radio Mfg. Co.

BOSTON, MASS.
Atlantic Radio Co.,
88 Broad Street

BROOKLYN, N. Y.
Kelly & Phillips,
312 Flatbush Ave.

CHICAGO, ILL.
Chicago Radio Laboratories,
1316 Carmen Ave.

EUREKA, ILL.
Klaus Radio Co.,
Branch, Peoria, Ill.

KANSAS CITY, MO.
McCreary Radio Supply,
4th & Delaware Sts.

LOS ANGELES, CALIF.
The Wireless Shop,
511 W. Washington St.

NEW ORLEANS, LA.
Rose Radio Supply,
604 Gravier St.

NEWARK, N. J.
A. H. Corwin & Co.,
4 West Park Street

NEWCASTLE, PA.
Pennsylvania Wireless Mfg. Co.,
507 Florence Ave. "8HA"

OMAHA, NEBRASKA
O-B Radio Supply Co.,
406 Brown Building

PHILADELPHIA, PA.
Philadelphia School of Wireless
Telegraphy,
Broad and Cherry Streets

PROVIDENCE, R. I.
Rhode Island Elec. Equip. Co.
45 Washington Street

PORTLAND, ME.
Atlantic Radio Co.,
15 Temple St.

PITTSBURG, PA.
Radio Electric Co.,
3807 Fifth Ave.

SEATTLE, WASH.
Northwest Radio Service Co.,
609 Fourth Ave.

SCRANTON, PA.
Shotton Radio Mfg. Co.,
P. O. Box 3,
Branch 8 Kingsbury St.,
Jamestown, N. Y.

ST. LOUIS, MO.
The Benwood Co., Inc.,
13th and Olive Street

TORONTO, ONT., CAN.
The Vimy Supply Co.,
567 College Street

WICHITA, KAN.
The Cosradio Co.,
1725 Fairmount Ave.

Responsible Dealers: Write for interesting sales proposition on Radisco apparatus

If none of the above agencies are in your vicinity, or do not give you the desired information on Radisco Apparatus, communicate with

RADIO DISTRIBUTING COMPANY; : : Newark, New Jersey

Here's How to Hook Up Your Radio Service Audion Control Panel—

Just hook up your Radio Service panel as this diagram shows. You will get a new idea of efficiency in radio apparatus at an amateur's price. *Description*—Machined bakelite panel 6" x 3 1/2", navy standard socket and rheostat mounted on hard wood base; metal parts nickel plated. Thoroughly tested and guaranteed to work fully as well as any more expensive panel.

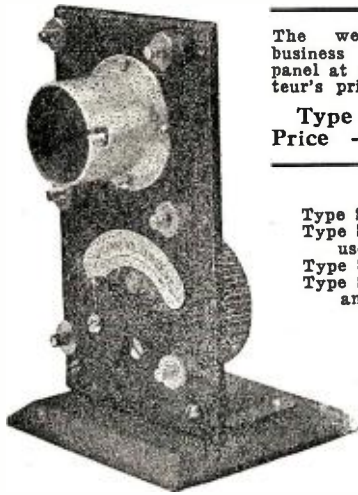

The well-made, business-like panel at an amateur's price!

Type S 11
Price - \$7.00

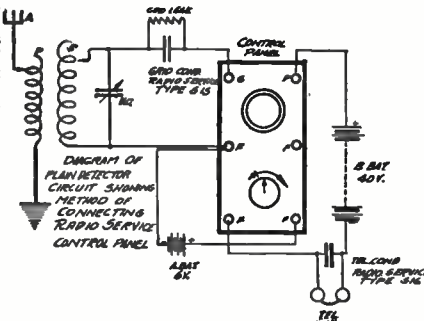

Schedule of Prices on VT Sockets

Type S1—Single Tube (for inside mounting).....	\$1.25
Type S2—Single Tube (for bench and experimental use)	1.75
Type S3—Double Tube (for amplifier use).....	3.00
Type S4—Triple Tube (for detector and two-stage amplifier or three-stage amplifier use).....	4.00

New Single Socket
Spun aluminum socket—machined bakelite base 3 1/4" square. Heavy phosphor bronze contact springs. Metal parts, nickel plated.

Type S 10 - Price \$1.10



All leading dealers or by mail from
RADIO SERVICE & MFG. CO.
Lynbrook, L. I., New York

Registering Radio Messages on Tape

(Continued from page 276)

OPERATING DATA

Using an ordinary crystal detector receiver with an aerial one hundred feet long and forty feet high at both ends, the recorder will register incoming signals from 750 to 1200 miles under favorable operating conditions.

Using a vacuum tube detective circuit and connecting the recorder in the phone cir-

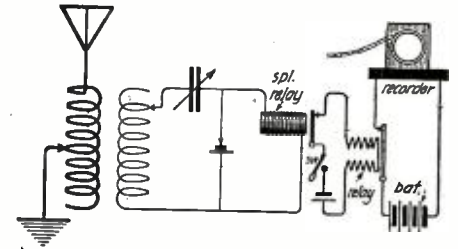

Fig. 1. Schematic Wiring Diagram of the Recorder Mentioned Here. The Success of the Instrument Lies in the Proper Operation of the Special Ultra-sensitive Relay Shown Connected in the Detector Circuit.

cuit, stations have been successfully copied from 1800 to 2600 hundred miles; this, of course, depending upon desirable atmospheric conditions.

In all of the above cases Brandes receivers were used. The aerial employed was a single strand copper wire, one hundred feet long and forty feet high at both ends.

ANOTHER AMATEUR DISPLAYS HIS WORTH

When a storm recently destroyed telephone connection between Fort Dade, Florida, and the outside world, the radio station and equipment of Loren Davis, located on top of the Wilson-Chase Building at St. Petersburg, Fla., kept the fort in touch with authorities in Washington, D. C.

Telephone connection with Bradentown and Tampa was restored several days later and Davis was relieved of his important duties. He was thanked in no uncertain terms by the military authorities.

Special authorization from Washington was granted for the routing of telegrams through this amateur station, which is known as 4-CS. Messages sent to Bradentown for the military authorities at the fort were relayed to St. Petersburg and delivered to Davis to be transmitted by radio to the fort. Ten messages of this character were handled by young Davis Friday.

Just before the storm broke aviators from Carlstrom Field, who had made a flight to the fort, had left for their home field. Anxiety was felt for their safety. It was through the Davis station that word was transmitted to the fort that the aviators had arrived safely.

MICA DIAPHRAGMS, BOYS.

Sheet mica, split to about the thickness of heavy bond paper, will make excellent wireless phone diaphragms. It should be cut out to the correct size with a pair of sharp dividers, and a half-inch circle of sheet iron, from an old metal diaphragm should be shellacked to the center. The metal should be on the side of the mica away from the phone magnets.

If your phones have strong permanent magnets use heavier mica, if weak, vice-versa. This scheme seems to bring in the faint signals more clearly, while it dulls the strong ones a trifle.

Contributed by A. D. KEOGH.



PARAGON POST RHEOSTAT \$1.75

For back of panel or table mounting, 2 1/2" dia., 6 ohms, 1 1/2 amps. Immediate shipment.

NEW—NEW—NEW
10,000 ohm Grid Leak for VT Transmitters, \$2.00

ANTENNA WIRE 1c PER FOOT

7 strands, No. 22 copper, tinned to prevent oxidation. Include postage on 15 lbs. per 100 ft.
Lightning Switch, 100 amp., 600 volts.....\$4.00
Young & McCombs Rotary Spark Gap.....16.00
Side Action "Cootie" Key, 1/2 K.W., N.P..... 5.00

DeForest CV500 Variable Condenser, without knob and pointer, value.....\$6.05
Large Gorwin Knob and Dial to fit, value..... 1.70

Combination Price \$6.25; value.....\$7.75

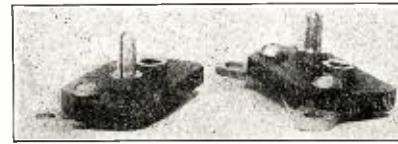

AUDIOTRON ADAPTOR

Consists of standard 4-prong base with brass supporting connectors; permits mounting tube in vertical position so filament will not sag and touch grid.

\$1.75 Postpaid

Improved Standard VT Socket, \$1
Electron Relay (improved), \$6
A-P Amplifier BT (SE 1444), \$7
Copper Foil Grid Condenser, 35c
Chelsea Variable Grid Leak, \$3

44 Volt Variable B Battery

\$3.60 (Plus Postage on 4 lbs.)
Complete in handy wooden case with adjustable phosphor bronze "Jiffy" Connectors. Better than block batteries. If one 4.4 volt unit weakens prematurely, it can be removed and replaced, thereby not impairing the total voltage—making this the best battery value on the market; fresh 4.4v renewal units always in stock.
40c each, or \$3.10 per 10, plus 4 lbs. postage

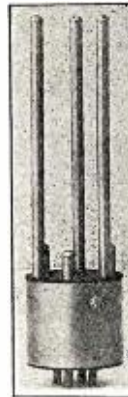

HONEYCOMB COIL ADAPTORS

\$1.50 PER PAIR

Attach to binding posts of a Murdock Variable Condenser—insert H-C Coil—making a Tuning Unit. Two Units make a Loose Couple, a third makes a Tickler Coil. One makes a first class Wavemeter.

RADIO EQUIPMENT CO., 630 WASHINGTON ST., BOSTON, 11, MASS.
— 4th FLOOR —

Canadian Amateurs

Write to our nearest branch for Price List "B" of Radio Apparatus, Supplies and Publications.

Scientific Experimenter Limited

Dominion Bldg.,
Vancouver, B. C.
Arcade Bldg.,
Halifax, N. S.
Head Office,
11 St. Sacramento St.

Confederation Life Bldg.,
Winnipeg, Man.
Vaughan Electric Co.,
94 Germain Street
St. John, N. B.
MONTREAL, QUEBEC

93 King St., E.,
Toronto, Ont.
Board of Trade,
St. John's, Nfld
Show Rooms,
33 McGill College Avenue

"The Greatest Radio Catalog in the World—"

The Universal Verdict of Tens of Thousands of Radio Amateurs

DUCK'S No. 14 Big 200 Page Wireless Catalog

A VERITABLE Treasure House of Everything Worth While and Dependable in Radio. The largest, most comprehensive, artistic and educational wireless catalog published. The Beacon Light to

guide you right in the selection of your radio purchases, and at prices that will command your attention. Every instrument guaranteed with privilege of return if not satisfied.

Mail 12c in stamps or coin (*not sent otherwise*), which amount you are privileged to deduct on first dollar purchase. Revised price list to first edition of catalog, with prevailing prices, mailed on request.

Announcing the Original "Duck" Service

Practically every order being shipped within 24 hours after receipt

Tremendous Christmas Stocks—

WITH a business of unprecedented volume ever since the close of the war. With nothing short of miserable service from our many sources of supply, and many other unusual conditions to contend with, we found it impossible, up to a comparatively short time ago, to give the service on orders for which we always enjoyed such a high reputation, and which was our pride. We deliberately curtailed our advertising, because we could not get catalogs printed fast enough and because we did not want a volume of business we could not expeditiously handle. We are now able to guarantee the wonderful service that our thousands of patrons received for many years before the commencement of the war.

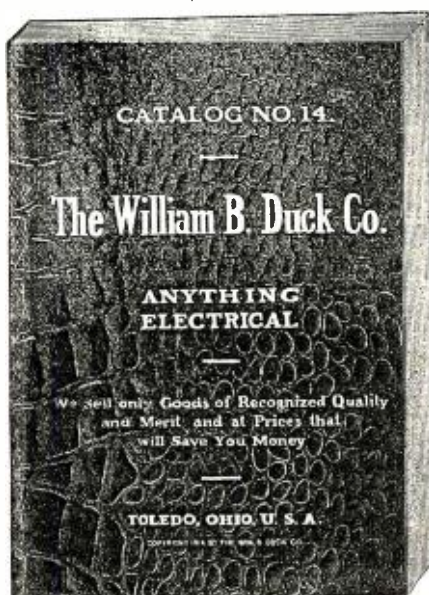

Send 12c for this wonderful catalog today. Revised price list to first edition of catalog No. 14 mailed on request.

3 Big Specials

November 15 to December 15

DURING the above period, planning on a terrific demand, we are placing truly remarkable prices on three of our most popular radio instruments. These low prices are possible only because of tremendous quantity production.

Model 5BB Navy Type Receiving Transformer, Regular price \$27.50. Special Price only \$21.95



A BIG improvement over our former model. Primary divided into four sections, with three dead end switches, greatly improving selectivity. Secondary divided into three sections, with two dead end switches, eliminating harmonics. The change in the construction of the guide rod support makes it possible to obtain a looser coupling. It is a wonderful improvement over our old model, both in appearance and performance.

Improved Arlington Receiving Transformer, Regular price \$15.00. Special Price only \$11.95

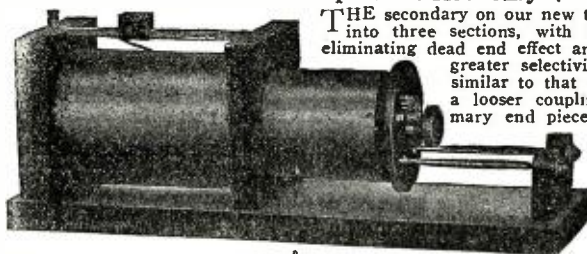

THE secondary on our new type Arlington is divided into three sections, with two dead end switches, eliminating dead end effect and harmonics and giving greater selectivity. The end support is similar to that on our Navy, permitting a looser coupling. The base and primary end pieces have a spline to prevent warping or damage in transit. This feature is also on our Navy. It is a beautifully finished instrument.

Improved Type Sayville Rotary Gap

Embodies the latest and best features in Spark Gap Construction.

Our New Type Sayville Rotary Gap is, we believe, far in advance of any rotary gap on the market within a range even of twice the price. It is the final development of many different types made in our experimental Radio Laboratory. It fulfills every requirement of the ideal rotary gap. It is neat and attractive in appearance; simple and durable in construction; possesses a wonderful motor; has a cast aluminum rotary wheel, beautifully polished; every part is in perfect alignment; there is no wobbling of the rotor; produces and maintains a clear and pure 500-cycle note; is instantaneous in action; permits of no dragging of the spark; has contacts of tempered flat copper of proper length and width, easily and quickly removable, and inexpensively renewable; the stationary contacts are adjustable to any length.

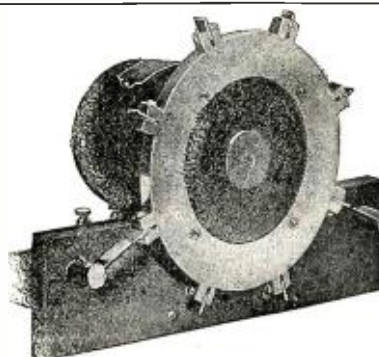

No. 7721 Receiving Transformer, Regular price \$9.00. Special Price \$7.50

THE WILLIAM B. DUCK CO., 231-233 Superior St., Toledo, Ohio

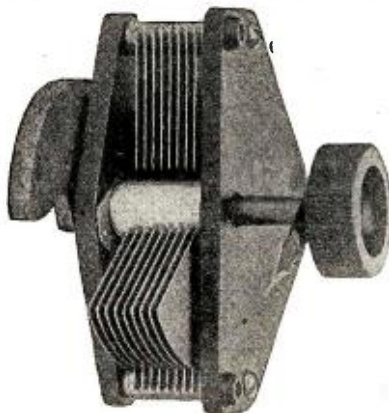

Condenser No. 4

CHELSEA Variable Condensers (Die-Cast Type)

- No. 1.—.0011 m.f. mounted. \$5.00
- No. 2.—.0006 m.f. mounted. \$4.50
- No. 3.—.0011 m.f. unmounted \$4.50
- No. 4.—.0006 m.f. unmounted \$4.00

Top, bottom and knob are genuine bakelite, shaft of steel running in bronze bearings, adjustable tension on movable plates, large scale reading in hundredths, high capacity,

amply separated and accurately spaced plates.

Unmounted types will fit any panel and are equipped with counterweight.

CHELSEA OSCILLATOR

Enclosed within the bakelite base are three small mica condensers, two of which form the capacity coupled feed back circuit and one constitutes the grid condenser.

This instrument entirely eliminates the use of all tickler coils in undamped long wave reception.

Range 3,500 to 20,000 meters, full instructions with each instrument.

Purchase Chelsea Apparatus from your dealer.

CHELSEA RADIO CO.

Manufacturers of Radio Apparatus and Moulders of Bakelite



PRICE \$3.00

15 FIFTH STREET
CHELSEA, MASS.

The Radio Compass on Board Merchant Vessels

(Continued from page 271)

GENERAL RADIO COMPASS ACTIVITIES

In the Bellini-Tossi type of radiogoniometer two loops at right angles to each other are connected to simultaneously tuned circuits which make up the primary of a loose-coupled device. The secondary, or detector circuit is pivotally mounted in such a way as to be acted upon by an equal amount of the primary circuits of both loops. The two antennae are affected proportionally as they point in the direction from which the waves are coming; the antenna which is in nearer a direct line being the one which secures the greatest amount of energy. With the active elements of the goniometric loose-coupler arranged at right angles to the exploring coil, which carries the winding of the secondary circuit, it may be seen that the loudest signal is received when the exploring coil is in the greatest cumulative magnetic field of the two primary circuits. With the goniometer properly arranged as regards its position relative to a magnetic compass the direction from which signals emanate may be determined, making allowance for the above mentioned error.

One disadvantage is the fact that the exploring coil will respond to two distinct maximum settings and ambiguity arises as to whether the signals are from any given direction or the direction exactly opposite. Knowledge of radio working and some idea of location soon enable the experienced observer to distinguish between the correct and the improper decision.

An outstanding feature to be considered in connection with the setting down for fact the degree of error in the above outlined set is that a possible slight error may have occurred in connection with the reports from the vessels from which reports were received and the checking made. It should be remembered that these tests were made with a carborundum detector. Greater distances may be covered with the vacuum tube and by reason of the fact that the V. T. is a far better rectifier than the crystal detector, it will allow much sharper tuning which will, of course, cut down error.

The above described type of goniometer was used on the S. S. *Comus* for a period of about six months. Following the end of the war Captain Maxson has been doing a little work with the newer type goniometer which use a single loop, pivotally mounted, for rotation throughout a complete circle. For guidance in the construction of this loop, which has been entirely made and installed by the Captain and his radio man, Mr. Paul Krieger, the findings of Mr. A. S. Blatterman, who has written copiously on the subject, were followed very closely and much assistance derived therefrom.

A loop about four feet in diameter, supported and wound as shown in the photographs, was mounted above the navigating bridge of the *Momus* and connected, in conjunction with suitable tuning apparatus, to a Grebe detector and two-stage audio frequency amplifier unit. A small house was built on the vessel's bridge and as far away as possible from any of the metal parts which would naturally be looked upon as trouble-makers. Means for the rotation of the loop were provided and inside the housing an arrow moved over a scale to show the exact position of the loop. In fact, the whole was just about what one would look for in a reliable radio compass station.

The results obtained were very disappointing. Some error was to be expected, but it was thought that by careful observa-

"SORALA"

RADIOPHONE SPECIALTIES and other accessories from our stock of standard apparatus of best available makes—may be added to the "Nucleus" at your convenience, to suit your individual needs.

4c SENT FOR PRESENT Bulletins

Will put you on our mailing lists. Keep informed.

We offer prompt and reliable service in repairing Vacuum Tubes, Audiotrons, Electron Relays, Moorhead VT's, Marconi VT's } **\$3.50**

Pack Each Tube Carefully!
Cash Must Accompany Order!
Other Makes Quoted on Application.

"A FEW TIMELY SPECIALS"

- "Paragon RA-10" Regenerative Tuner, \$65.00
- 160-1090 meters, none better for phone work
- DeForest Buzzer Radiophone.....\$135.00
- Radiation, 1/2 amp., ready for use.
- Eveready, 6 volt 60 A.H. non-sulphating storage battery 20.00
- 75 Watt, 350 Volt Motor Generator.....\$115.00
- Ball bearing, single housing, single shaft.
- Bakelite VT Sockets, non-melting.....\$1.10
- Bronze Fahnestock contacts and binding posts.
- Moorhead Transmitting Tubes.....\$7.50
- Electrodyne Rectifier VT's.....\$7.00
- Vitreous Enameled Transmitting Grid Leaks, 5,000 ohms, \$2; 10,000 ohms.....\$2.60
- Dubiller, 1,000 Volt, .0005 m.f. Grid Condenser\$1.00
- Type J 0-5 D.C. Ammeter, flush type...\$6.00
- Type J 0-500 Voltmeter, flush type...\$14.50 (Includes external aluminum cased resistance)

We Are Recognized Leaders in Supplying
RADIOPHONE & "CW" ACCESSORIES
SOMERVILLE RADIO LABORATORY

THE "NUCLEUS"

at \$36.00

is a WORKING FOUNDATION for a practical, up-to-date and distinctive WIRELESS TELEPHONE.

It consists of the following instruments, assembled on a grained bakelite panel 9 1/2" x 9 1/2" with missioned oak base.
General Radio \$10. Hot Wire Ammeter.—in 0-1, 0-2 1/2 and 0-5 amp. readings.
Western Electric Microphone Transmitter, with Bracket, \$5.
Sorala-J \$6. Plate Current Milliammeter, in 0-100, 0-300 and 0-500 M.A. Ranges.
CSU-6 variable Condenser, \$6.35, with Silver Plated 4 1/2" Navy Dial Indicator.

The above are essential to a practical 'phone, but may be purchased separately, if desired. Orders for the "Nucleus" should be placed immediately for prompt shipment. Special—We will allow transportation charges on orders placed before Jan. 1, 1921.

Preserve this adv.—it will not appear again. Every item represents an exceptional value!

- 3 IN 1 KNOB, POINTER AND SHAFT
- Paragon Rheostat, 6 ohms, 1 1/2 amps. \$1.75
- General Radio Rheostat, 7 ohms, 2 amps., \$2.50 (Black oxide mounting screws supplied.)
- 50 Watt 325 Volt Rectifier Transformer, \$12
- Acme Modulation Transformers (semi-mounted) \$5
- Honeycomb Coil Adaptor..... 75c
- Has adjustable arms, permitting new uses.
- Fahnestock N.P. Bronze Binding Posts, 50c. doz.
- Large Panel Binding Posts, 18c., \$1 per 6
- Knurled Knob Tops, M.P. Brass Bases, Small Instrument Switch 30c each
- Knurled Knob, N.P. Bronze Blade and Bearing Surface, very attractive.
- MANUFACTURING DESIGNERS—DISTRIBUTORS
102 Heath St., SOMERVILLE, MASS.

tion it could be plotted and accounted for in the reckonings. The error appeared, but it was so great and so inconstant as to render the device impractical. At times errors were detected as great as sixty degrees. Most accurate readings were obtained from stations ahead. The error from stations astern was great and varied, though stern bearings were generally found more accurate than those from points off either beam. The plotting of a curve denoting the error from various angles was therefore abandoned.

Regardless of the disappointment this type of goniometer has been coupled with, it is believed to be amply justified for use on shipboard, when the possibility of using it in conjunction with saving distressed vessels is considered. Even though the readings were not positive, such a device would enable one steamer to find another in a fog. With any error less than ninety degrees it would be possible for the searching steamer to spiral in the direction of the one in need, and where it has been possible to turn the ship in the direction of the point from which the signals emanated a much smaller error was noted which would mean the more rapid location of the steamer sought. The same applies to the location of a shore station. In any event, where there is the impending danger of running down the object sought, because of fog or similar reasons, it will be understood that the benefits to be derived from radio compass bearings will depend a great deal upon the knowledge of the man making the observations.

With the V. T. the operation is a great deal more to be relied upon, and it is generally possible for an experienced man to tell approximately how far he is from a station, whereas with a crystal detector a radio man might think because the received signals were weak that he was receiving from a great distance, when the true reason for the weak signals was an improperly adjusted detector.

Captain Maxson's tests with both the systems mentioned cover a period of six months each. His opinion is that the Bellini-Tossi type is by far the most practical goniometer for ship use, as it does not seem to be so easily effected by irregularity of the conditions which obtain afloat. Allowing for the improvement which could be made by the use of the V. T. in conjunction with amplifying circuits for covering greater distances, he is of the belief that the radiogoniometer would be of infinite value to all mariners and that its use would soon prove that the expenses involved was warranted. It is just another safety device which in addition to safeguarding life at sea, allows for better general navigation and therefore the operating of steamships on a much more accurate schedule.

DIRECTION INDICATOR

A device which has proved of great value in the making of the above described tests is shown in Fig. 1. A complete circle is marked off in degrees, on a round, flat piece of brass. A pivot (b) is placed in the center of the brass plate and forms the support for three radially moveable arms. (c), (d) and (e). Upon the arms (c) and (e), at points equidistant from the center pivot (b) are placed two other pivots, (f) and (g), respectively. The arm, (d), incorporates a long slot (i) through which moves the pivot, (h). Two additional arms, (j) and (k) extend between the points (f) and (h), and (g) and (h), respectively.

It will be seen from the drawing, that regardless of the distance either one of the arms (c) and (e) are made to rotate, the arm (d) will always be in the center. For rapid chart observations this device has proven invaluable.

(Continued on page 312)

This may be your last chance



to procure the Famous Croft Library of Practical Electricity at the present price.

A steady decline in the prices of nearly all commodities can now be looked for. But it is different in the publishing business. Paper has gone up 300%, and is still advancing. Considering that our forests are being rapidly depleted, and that pulp from which paper is made is getting scarcer every year, it may be only a short time until the price of every piece of literature of any kind will be doubled or trebled.

8 vols. flexibly bound



Electricity as experts know it—NOT ONE CENT DOWN

Terrell Croft is not a wonder-worker. He is merely a man who has climbed up in the world of electricity from the lowest paid apprentice. He possesses the happy combination of ability to both do a thing and then explain how it is done, in clearest English and in simplest mathematics. Probably no other author or instructor has more fully and understandingly covered the practical side of electrical work as it is actually done. There have been so many instances where these books have helped men quickly to bigger positions with bigger pay, that they are the best and most widely known electrical books in existence. The most intimate personal instruction could not be more effective in enabling the student or the experienced man to "know electricity as experts know it."

Read This—

Electricity, from the simplest principles to complete and economical operation of a central station—
Motors, generators, armatures, commutators, transformers, circuits, currents, switchboards, distribution systems.
Electrical machinery of every type, installation, operation and repair.
Wiring for light and power. How to do it mechanically perfect in accordance with the National Electrical Code.
Wiring of finished buildings. Underwriters' and municipal requirements. How to do the complete job, from estimating it to completion.
Illumination in its every phase. The latest and most improved methods of lighting. Lamps and lighting effects.
A complete course in mathematics as applied to work. A course which refreshes your mind, and gives you mastery of all the short-cuts in figuring.
Electrical practice complete. Electrical practice as experts know it. Electrical practice by experts.

If you want to get out of the amateur class you must know the practical side of Electricity.

After the present printing is exhausted it will never again be possible to supply a practical electrical education at \$20.

Send no money now—merely the coupon



Price mentioned in this coupon subject to advance.

McGraw-Hill Book Co., Inc.,
239 W. 39th St., New York.

Gentlemen:—Please send me the Library of Practical Electricity (shipping charges prepaid), for 10 days' free examination. If satisfactory I will send \$2 in ten days and \$3 per month until \$20 has been paid. If not wanted, I will write you for return shipping instructions.

Name

Home Address

City and State

Where Employed

Occupation R.N. 11-20

(Continued from page 311)

Editor's Note: It is to be hoped that the excellent results secured by Captain Maxson will be brought to the attention of the other mariners who will at least inquire into the merits of the radio compass with a view to its more general use on board ships. The United States Naval Radio Service is directly responsible for the great aid given to coastal navigation up to the present time and needless to say the radio compass or direction finder plays a most important role.



899 Boylston St.
Boston, Mass.

FALL CLASSES !!!

In addition to the splendid radio equipment now in use at the EASTERN RADIO INSTITUTE, we wish to mention the installation of—

A COMPLETE NEW 2 K.W. FEDERAL ARC TRANSMITTER. THIS IS AN EXACT DUPLICATE OF THE HUNDREDS THAT WILL SOON BE IN USE ON VESSELS OF THE U. S. SHIPPING BOARD.

Commercial operators and operators in training are cordially invited to inspect this splendid equipment. Special instruction can be secured upon this apparatus by appointment.

Prospective students will find instruction on this set incorporated in our course.

REMEMBER. We are the only school in New England giving this instruction upon actual Federal Arc Apparatus.

When you take into consideration that the Institute was founded in 1913 and has specialized in the training of Wireless operators for over seven years we feel that we know how to give the student proper training. Our graduates may now be found all over the world as Chief operators, Chief radio inspectors, Engineers, Superintendents, Directors of corporations, etc. The number of students to whom we have given instruction at this date numbers over four thousand (4,000). Remember—we have actually enrolled, graduated and placed more Commercial operators than ALL the Radio schools in New England combined.

If you are considering taking up Commercial radio why not let us train you? Our rates of tuition are reasonable and it costs you no more to avail yourself of our YEARS of RESULTS and SUCCESS. Just remember—we have trained thousands of satisfied students before you and have placed ALL our graduates in good positions. What we have done for them we can do for you.

DAY AND EVENING CLASSES, START ANY MONDAY. WE EARNESTLY URGE YOU TO MAKE EVERY EFFORT TO JOIN THESE CLASSES, AS RADIO TODAY OFFERS A VAST FIELD FOR ACHIEVEMENT AND SUCCESS.

Our latest, illustrated prospectus giving you complete information is yours for the asking. If there is any further information I can give you just drop me a line or come in and see me.

Co-operatively yours,
F. D. PITTS, Director.

Enter the Radio Preacher

(Continued from page 270)

and beat it for the Methodist Church a couple of blocks away; the preacher had just started his sermon, and strange to say his subject was "Home the Sweetest Place on Earth." I tell you O.M. I just swallowed that sermon whole and after the service I went down front took the old preacher aside and told him my troubles. Well, we talked it over and then we went over to my mother-in-law's house, wife had not gone to bed yet. We had a little prayer together, and today we are all back in our little home again the three happiest kids you ever saw; and best of all radio did it. Well, I guess you had had enough of this, so C U L."

HOW I DRIFTED INTO THE GAME

It may be of interest to the reader to learn how I first started in radio work. Some sixteen years ago when the Electro Importing Co. put out its first catalog; a little paper covered book which contained descriptive matter on spark coils, coherers and the like, I became keenly interested and like the boys of today it was not many years before I found myself sitting up late at night over a simple tuning coil and a piece of silicon. About all that could be heard in those days was NAA on time and weather, and the fellow who got time signals from Arlington was "going some." There were but few stations in New England then, but whenever I found a station I did not fail to visit it and gain all possible knowledge of this wonderful phenomena. I spent many spare hours in a station installed by the National Tel. & Tel. Co., where I helped to construct what we believed to be the first rotary gap. It was made by mounting brass balls on brass rods which were inserted in a steel hub. This was quite a novel gap for those days and produced a very peculiar tone as compared to the old stationary gap.

In conclusion I want to say that I am not the only person who believes that radio—amateur radio, mind you—is far from having reached the limit of new and distinct uses. Preaching by radio is but one of the many things which the radiophone of the future will do.

KNOB—MAKE THEM YOURSELF.

Neat and serviceable insulating knobs for that tuner may be moulded from black sealing wax. Make an impression in clay or plaster of paris with any knob you have on hand and desire to reproduce. Then melt the sealing wax in a tin can and pour it into the impression. Before the wax hardens insert a thumb screw of the battery type beneath its surface. Finish off with fine sandpaper and shellac. Red sealing wax will serve as well if it is painted with black shellac or india ink.

Contributed by A. D. KEOGH.



A RAY-DI-CO CONDENSER

ELIMINATES YOUR CONDENSER TROUBLES

No insulation breakdowns—Bakelite—Dilecto used throughout. Will stand high voltages making it ideal for vacuum tube transmitters. Extremely low energy losses.

NO SHORT CIRCUITS ACCURATELY SPACED

and securely fastened, insuring a CONSTANT CAPACITY evenly distributed throughout the entire scale. Fine for wavemeter and vacuum tube receivers. POSITIVE CONTACT with rotating element with a lug to solder lead to. Designed upon the SQUARE LAW principle, constructed to comply with U. S. SIGNAL CORPS requirements and used extensively by them.

This instrument should not be confused with the ordinary amateur condenser.

PRICE UNMOUNTED WITHOUT KNOB
or dial, postpaid in U. S.
Knob and dial 35c extra

\$1035

RAY-DI-CO. (NOT INC.)

2653 N. Clark St., Chicago, Ill.

Specializing in the designing and construction of Radio Phones to your specifications,

Gassy or Soft Vacuum Tubes Are The Best Detectors



No. 7650 Standard Vacuum Tube Plate Battery. (Patent Applied For) Price \$3.50

IT is a fact that gassy or soft vacuum tubes are still the best detectors, but in order to obtain the maximum efficiency from such tubes it is absolutely essential that a variable plate battery be used. The No. 7650 VARIABLE STANDARD VT BATTERY is constructed in such a manner that the voltage may be adjusted by steps of $1\frac{1}{2}$ volts for any plate potential from $1\frac{1}{2}$ to $22\frac{1}{2}$ volts. This is accomplished by having permanently soldered "Arranbee" jacks at each cell and using an "Arranbee" plug with flexible lead, which combination ensured perfect connection wherever employed. Not only do we supply the battery herein described, but we also handle a battery of the Signal Corps type and the Navy type, as follows:

No. 7623 Signal Corps type $2 \times 2\frac{1}{2}$ inches \times $3\frac{3}{8}$ inches, 250 hours service \$1.50.
 No. 7625 Navy type $6\frac{1}{2} \times 4 \times 3$ inches, 1200 hours service, \$2.65

Dealers, Jobbers, and Distributors, write for our discounts

The STANDARD VT BATTERY will be found on sale at all live dealers. The guarantee protects you.

Insist on the Standard V.T.—Do Not Accept Substitutes

PACENT ELECTRIC COMPANY, Inc. REPRESENTING:

A. H. Grebe & Co., Inc. Builders of Regenerative Receivers and other radio apparatus of distinction. Complete new catalog will be sent on receipt of 10 cents in stamps.
Dubilier Condenser Company, Inc. Builders of Mica Condensers for transmitting, receiving and laboratory work. Catalog will be sent on receipt of 10 cents in stamps.

Richter-Schottler Co. Manufacturers of dry batteries for vacuum tube work. Bulletin B1 is yours for the asking.

The Magnavox Company. Manufacturers of loud speakers, power amplifiers, voice and music amplifying equipment. Bulletin on request.

Rawson Electrical Instrument Company. Manufacturers of ultra-sensitive instruments for precision and research work.
Electrical Products Mfg. Co. Manufacturers of Duo-Lateral Coils and other machine wound coils for radio and electrical equipment. Bulletin P1 is yours for the asking. Inquiries on special coils will be given our attention.

150 Nassau Street

Telephone Beekman 5810

New York City

NOTICE

In the infringement suit DUBILIER CONDENSER CO., Inc., plaintiff vs. Wireless Specialty Apparatus Co. defendant, a final decree has been handed down by his honor, Augustus N. Hand, U. S. District Judge for the Southern District of New York holding

"That SAID LETTERS PATENT NOS. 1,229,914 AND 1,229,915 ARE GOOD AND VALID IN LAW AS TO THE SECOND, THIRD, FOURTH, FIFTH, SEVENTH, EIGHTH, NINTH, TWELFTH, FOURTEENTH AND FIFTEENTH CLAIMS OF LETTERS PATENT NO. 1,229,914 AND AS TO THE FIRST, EIGHTH, TWELFTH, SIXTEENTH AND SEVENTEENTH CLAIMS OF LETTERS PATENT NO. 1,229,915."

We hereby give notice that it is the intention of this Company to uphold to the full extent its rights under the above and all other patents held by us, and any one making, using or dealing in condensers covered by our patents without a license from us, will be held responsible to the full extent of the law.

DUBILIER CONDENSER CO., Inc.
 217 Centre Street
 New York City

THE ACME NON-RESONANT TRANSFORMER



Is to Amateur Radio

*What the Six Cylinder Car is
to the Automobile*

The high spark frequency permissible insures a steady flow of power coupled with the added advantage of the sensitivity of the human ear to the higher notes.

Ask the man who owns one.

ACME APPARATUS COMPANY

25 Windsor Street Cambridge 39, Mass.

Transformer and Radio Engineers and Manufacturers.

TUNING TRANSFORMERS

Immediate deliveries while they last

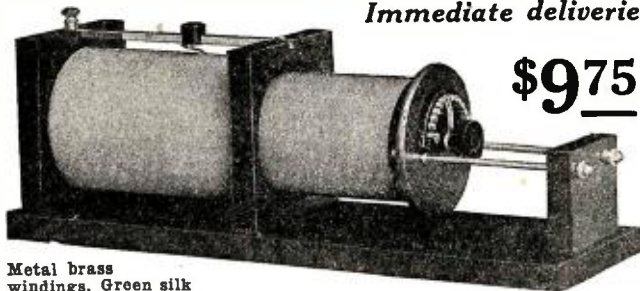

Metal brass windings, Green silk

\$975

PRICE

QUALITY

Manufacturer's Prices

Direct from Manufacturer to you. You save 30 to 40% paid dealers

Both instruments mahogany finish

Range 3500 meters Base 18 inches ABSOLUTELY GUARANTEED

Panel heavy hard rubber

Metal-nickel Winding

Green Silk

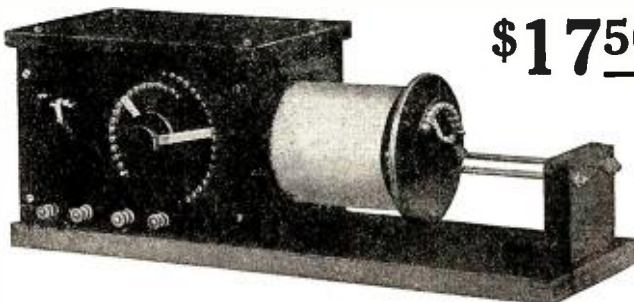

\$1750

G. M. PROUDFOOT, 361 East Ohio St., Chicago, Ill.

A VT Radio Frequency Amplifier

(Continued from page 287)

was about \$21.00. Certainly, the amateur cannot hesitate at owning an amplifier at this low cost.

The drawing shows how this was accomplished. The amplifying transformers, mounted on their cast aluminum stands, are placed at right angles to each other, directly above the Paragon 6-ohm rheostats, and on either side, are placed the VT's and sockets. There is just enough room between the rheostats for the small two-point step control switch. All this can be placed in a cabinet 6" x 8" x 4", altho a larger cabinet with more spacing to the component parts would be advisable when the builder has had little experience in wiring, as only the professional radio mechanic can connect the parts of a very compact amplifier in a way so that adjacent leads will not cause local induction.

It is a sound plan for the amateur to begin now to become thoroly familiar with amplifiers in view of the increasing use of radiophones. Because of the low decrement of the tube transmitter, very sharp tuning must be done at the receiving station. Now with a regenerative circuit, the signal must first be tuned in before starting the regenerations, thereby decreasing the effective range to that of a simple audion circuit. Hence, it becomes obvious that an amplifier must be used to amplify the weak radiophone signal before the plate to grid amplification function is made use of. Another use, in which at least one stage of amplification is needed, is when receiving Rome and Lyons, etc., on a few turns of annunciator wire strung up in one's room. In short, the amplifier is here, and here to stay; so get used to it.

At present the writer is working on an amplifier which uses two tubes for amplification at radio frequencies, and after rectification, the same tubes are used as audio-frequency amplifiers, similar to the French amplifiers. If he arrives at anything worth mentioning RADIO NEWS readers will hear of it thru an article. In the meantime the writer invites correspondence with anyone who has done anything along these lines.

CONCERNING THE RADIO PHONE SET OF MORTON W. STERNS

Concerning the article upon the radio-telephone set of Morton W. Sterns, which appeared on page 137 of September RADIO NEWS, it was stated that Mr. Sterns had actually employed his set for the benefit of the Radio Club of Brooklyn, which was holding a dance in the heart of Brooklyn, that the music was received at the hall on an indoor loop in connection with amplifier and loud speaking telephone. Incidentally, it was also stated that the music heard at the hall was heard by everyone present, loud enough to dance by.

In some unfortunate way this was a misstatement, as we have been advised by one of the officers of the Radio Club of Brooklyn, that the experiment was not successful to the extent mentioned.

RADIO REQUIRED FOR ALL SHIPS

American vessels arriving in British ports after December 1, 1920, will be subject to provisions of the British Wireless Act of 1919 so far as applicable according to an announcement made by the Department of Commerce. The act requires every sea-going passenger steamer or ship of 1,600 gross tons or more to be equipped with a wireless telegraph installation.

"USE THE TUBE THE NAVY USES"

On its remarkable trans-Atlantic flight the U. S. Navy flying boat NC-4 used A-P VT Amplifier-Oscillators. So efficiently did these A-P tubes serve on this flight, and so much did they contribute to the success of this great achievement, that voluntarily the Bureau of Engineering of the U. S. Navy wrote our Laboratories a letter of appreciation.

THIS
is the LETTER
THIS
is the TUBE

A-P tubes manufactured under the De Forest Audion and Fleming patents. Other patents applied for and pending.

AMATEURS—"Use the Tube the Navy uses"—the A-P VT Amplifier-Oscillator—price \$6. Order from your dealer. Descriptive pamphlet free upon request.

ATLANTIC RADIO SUPPLIES CO.
8 Kirk Place Newark, New Jersey

PACIFIC RADIO SUPPLIES CO.
638 Mission St. San Francisco, Cal.

Distributors for Moorhead Laboratories



THE A-P VT! AMPLIFIER-OSCILLATOR equipped with the SHAW standard four-prong base.

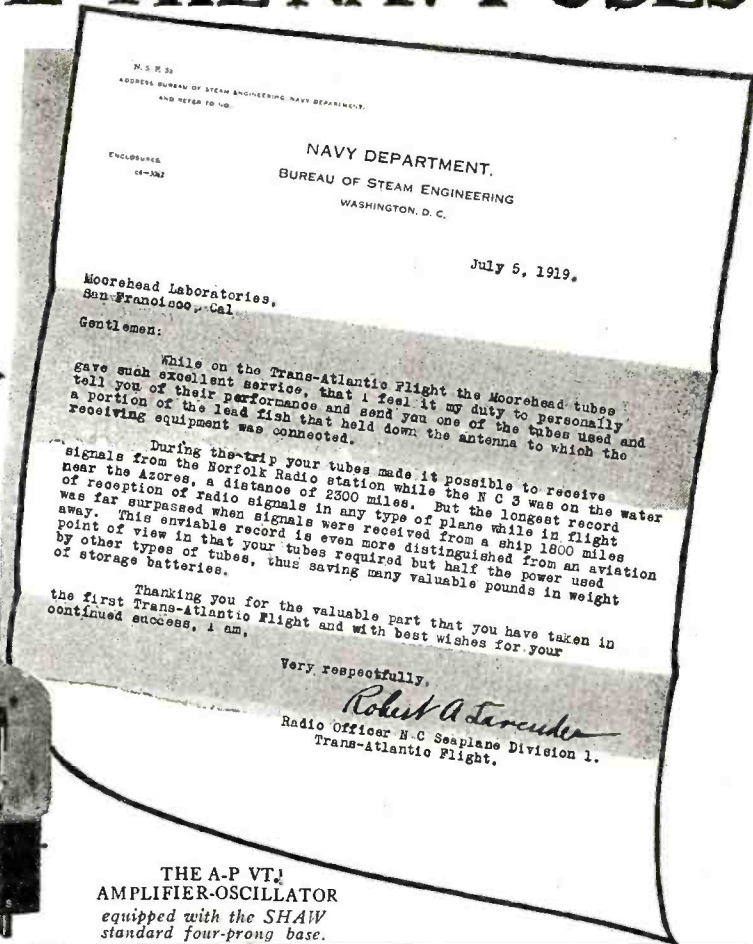

NAVY DEPARTMENT,
BUREAU OF STEAM ENGINEERING
WASHINGTON, D. C.
July 5, 1919.
Moorehead Laboratories,
San Francisco, Cal.
Gentlemen:
While on the Trans-Atlantic Flight the Moorehead tubes gave such excellent service, that I feel it my duty to personally tell you of their performance and send you one of the tubes used and a portion of the lead fish that held down the antenna to which the receiving equipment was connected.
During the trip your tubes made it possible to receive signals from the Norfolk Radio station while the NC 3 was on the water near the Azores, a distance of 2300 miles. But the longest record of reception of radio signals in any type of plane while in flight was far surpassed when signals were received from a ship 1800 miles away. This enviable record is even more distinguished from an aviation point of view in that your tubes required but half the power used by other types of tubes, thus saving many valuable pounds in weight of storage batteries.
Thanking you for the valuable part that you have taken in the first Trans-Atlantic Flight and with best wishes for your continued success, I am,
Very respectfully,
Robert A. Tarule
Radio Officer U.S. Navy
Trans-Atlantic Flight.



To the Discriminating

Radio-Craft caters to those who demand the best in Radio Apparatus.

Detector Unit
Price \$15.00



Insist on Radio-Craft products. Even with their outstanding superiority in design, materials and workmanship, Radio-Craft products cost no more than ordinary instruments.

- Radio-Craft apparatus is sold by
- Continental Radio & Electric Corp., N. Y. C.
 - Manhattan Electrical Supply Co., N. Y. C.
 - Radio Distributing Co., Newark, N. J.
 - Philadelphia School of Wireless Telegraphy, Philadelphia, Pa.
 - Kelly & Phillips, Brooklyn, N. Y.
 - McCarthy Bros. & Ford, Buffalo, N. Y.
 - Rudolph Schmidt & Co., Rochester, N. Y.
 - Atlantic Radio Co., Boston, Mass.
 - American Electro Technical Appliance Co., New York City.
- And Other Responsible Dealers

RADIO-CRAFT CO., INC.

Brooklyn, New York
Perfection in Radio Instruments

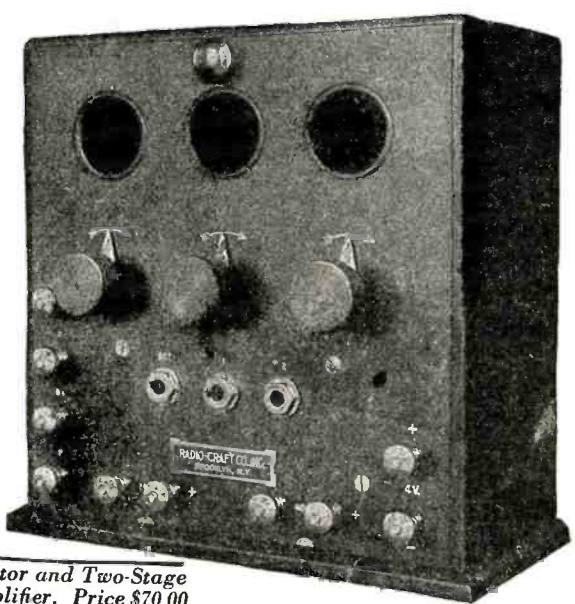

Detector and Two-Stage Amplifier. Price \$70.00

Try This Sensitive Radio Head Set

It is equipped with non-conducting spool heads and slotted pole tips which eliminate eddy current losses. Furthermore all operating parts of these

STROMBERG-CARLSON Radio Head Sets

are housed in dust and moisture-proof aluminum cases. Have adjustments for temperature variations. Strongly constructed; very sensitive for use on shore or aboard ship.

Bulletin 1206R gives full particulars. Write Today.

Stromberg-Carlson Tel. Mfg. Co.
ROCHESTER,
N. Y.



This sample set will be sent upon receipt of \$12. 6-foot moisture-proof cord attached. For commercial or private radio service. Money refunded if not satisfied.



TEST OUR PROMISE

of "Immediate Delivery" by sending us a trial order—you'll be surprised to receive the package in only a few days. We ship any piece of Standard Radio Apparatus same day your order is received. Give us your business—we'll give you SERVICE you will like.

Order direct from this page or write for Bulletin 5.

Vacuum Tubes		V.T. Sockets	
Electron Relays	\$6.00	Standard DeForest	\$1.50
Amplifiers	7.00	DeForest Panel	2.75
Transmitters	7.50	Ace (with Grid Leak)	1.50
Audio tubes	6.00	Murdock	1.00
Variable Condensers		Control Panels	
"Arc" Panel .001 M.F.	7.25	Acme Unit Detector	10.00
Clapp-Eastham Vernier	6.50	Acme Unit Amplifier	13.00
Chelsea Mounted	5.00	DeForest P-401	14.25
Chelsea Panel Type	4.50	Grebe RORH	17.00
DeForest CV-500	6.25	Telephone Receivers	
B Batteries		Baldwin, Type "E"	16.50
Burgess 22.5 Volts	2.25	Baldwin, Improved "E"	20.00
Burgess 4.5 Volts40	Federal A. & N., 2200 Ohms.	12.50
Standard Variable	3.25	Brandes Superior	7.00
Amplifying Transformers		Filter Material	
New Type Acme	5.00	Acme 1 1/2 Henry Chokes	4.00
Federal 226-IV	7.50	2 M. F. Condensers	1.25
Meters (General Radio)		Spark Gaps	
Ammeters, Scale 1, 2, 3, 5 or 10 amps.	10.00	Amrad Quenched, G-1	41.50
100 Milliamps	15.00	Amrad Quenched, G-2	24.50
250 Milliamps	11.00	Amrad Quenched, G-3	16.00
500 Milliamps	10.00	Benwood Rotary Discs	8.00
Chicago Amateurs—We are open Saturday		Stationary Electrodes	1.00
afternoons, come and see us.		Dubilier Condensers	
		250 Watts, .007 MF	19.00
		500 Watts, .007 MF	30.00
		1000 Watts, .007 MF	45.00

CHICAGO RADIO APPARATUS CO.

3400 South Michigan Avenue

CHICAGO, ILLINOIS



(GHEGAN PATENT)

Bunnell INSTRUMENTS Always Reliable

JOVE DETECTOR

Handiest, Handsomest, Best
Sample by Mail, \$2.00
Tested Galena Crystal, 25c

We are distributors of the Standard Electric Novelty Co.'s Type B "Cyclone" Audion Batteries. Also of De Forest and all the leading manufacturers of High Class Wireless Apparatus. Send stamp for new edition 42RN Catalog.

J. H. BUNNELL & CO., 32 Park Place, New York

Effective 150-20,000 Meter Reception

(Continued from page 273)

the contact jacks. Five similar units are also used in the secondary system.

A two-layer bank-winding divided into two sections is used for the secondary. The first section is tapt for intermediate waves of the lower band. Secondary tube, tickler and coupling coils are bracket mounted upon the rear of the panel.

An adjustable condenser of three values is provided to by-pass local oscillations across the detector tube components.

All parts are mounted directly upon the panel measuring 14" X 24" X 1/4". An oak cabinet encloses the receiver which weighs 28 pounds complete.

The detecting and amplifying unit is illustrated. Three Moorhead tubes are used in this unit.

It will be noticed that all tubes are controlled by a single rheostat, which is a most desirable method when the tubes employed are of the same make and type. For amplification, grid voltage is obtained through two Federal amplifying transformers.

Moorhead tubes function best with grid bias voltage placed at a value between 1 and 1.4 volts. On the first and second stage, the negative grid voltage are held at this value by shunting a small value of resistance in the rheostat. This value is best found by trial values over the rheostat, assuming that the filament current and voltage are normally adjusted.

Two large Burgess plate batteries are used. Twenty-two (22) volts are used on the detector; forty-five (45) upon the two amplifying tubes.

The method for fastening the plate batteries is shown clearly in the lower photo. Four 3/8" rods are mounted vertically by threading the ends into the base. Two oak plates carry a 1/2 inch thick pad of heavy felt on their underside. Wing nuts clamped down upon the upper plate binds the units tightly in place. It is impossible for them to move about with vibration or change of position.

All tubes are protected from shock by means of two absorbers further which may readily be seen in our illustrations and which is accomplished thusly: A formica platform bears the three sockets, and a strip of felt is placed between this platform and each supporting bracket. Bracket and platform are attached to respective edges of felt by small machine screws. This provides an ideal protection against shock which may occur on an operator's table.

A grid leak is mounted directly upon a small mica grid condenser provided for the first tube. Ordinarily this capacity should be adjusted by trial.

All parts are mounted upon a Formica panel 8" X 14" and enclosed in an oak cabinet. The weight complete is 21 pounds.

Both units have been described briefly. I trust that this may have suggested some feature or design that is acceptable to prospective builders. We depend much upon illustrations, which after all are more effective and explanatory than too detail and possibly confusing explanations.

This equipment was constructed entirely by hand with the few tools possessed by the average amateur. I also want to say there are no distinctly new devices or principles used.

As a matter of courtesy to the present owner, it is perhaps timely that mention be made that this equipment is now installed in the station of M. L. Potter, 9ABL, of Kankakee, Ill., as it was for this young man that this equipment was built.

A welcome addition to your library! Send \$2.00 plus postage today and your copy of bound volume No. 1 of Radio Amateur News will come forward by return mail.
Experimenter Publishing Company 236a Fulton Street, New York City



DeForest Audion-Unit Radio Receiving Station (6 Panel). "Honey-Comb" Tuning Coils, Tuning and Grid Condenser, Audion Detector, Head Telephones, "B" Battery, Aerial and Ground Connections, and all other needed supplies. A very efficient set of wide range.

Complete\$76.15

Complete Unit-System Receiving Sets for Amateurs

THESE complete Radio Receiving Stations offer the most satisfactory method of securing reliable, efficient, and scientific apparatus of absolutely dependable quality. They include everything required to set up and operate a Receiving Station that will operate satisfactorily and allow for expansion as the owner desires; including Aerial and Ground Connections, Panels, Base and Back Boards, Unit Panels, all screws, wiring, insulators, etc.

Both Sets are part of the famous DeForest Unit-System and additional panels to increase the range and selectivity of the sets may be added at any time. For the beginner, or even the experienced Amateur, these sets are the most logical system: They do away with costly cabinets and more costly factory assembly, thus saving money for the purchaser. They are also more instructive as by wiring the panels the Amateur secures practical information.

Send for Catalogue

DeForest Radio Apparatus should be on every Amateur's Christmas list. Send for our latest catalogue giving full, detailed descriptions of DeForest Receiving Apparatus. Sent postpaid for 10 cents.

DeForest Simplified Radio Receiving Station (3 Panel). Has "Honey-Comb" Tuning Coils, Crystal Detector, Tuning Condenser, Head Telephones, Aerial and Ground Connections and all other required supplies. An inexpensive set of wonderful performance. Complete\$47.35



DE FOREST RADIO TELEPHONE AND TELEGRAPH COMPANY

Inventors and Manufacturers of Amateur and Commercial Radio Apparatus
1401 SEDGWICK AVENUE NEW YORK CITY
Sole Western Distributors Lee DeForest, Inc., 451 3rd St., San Francisco, Cal.

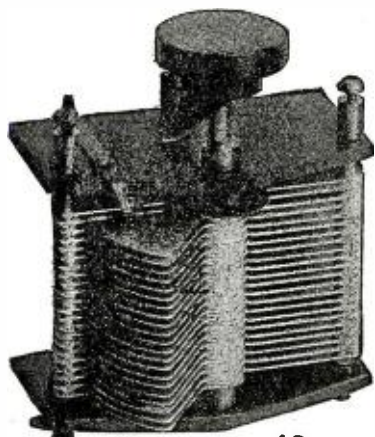

43

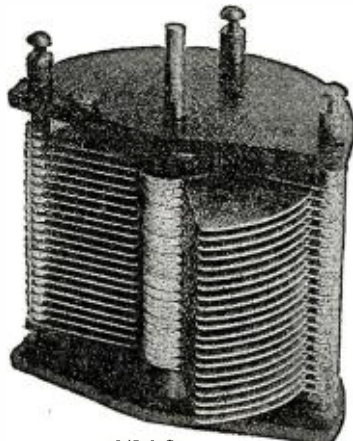

4300

Entire Satisfaction

is what our customers say.

ARE YOU

GETTING ENTIRE SATISFACTION from condensers you have purchased elsewhere?

IF NOT, we are sure you will be pleased with what we are offering, because, we manufacture *only* the BEST.

All we ask is GIVE US A TRIAL.

This month we wish to announce a NEW MODEL of VARIABLE CONDENSER, which will be known as SERIES "T". It is of the same general construction as our SERIES "S" condenser, but is built of heavier material, the aluminum plates being die stamped from 1/32" hard rolled stock. The spacers are also of heavier stock, and the general assembly insures a very rigid instrument. At the present time we are unable to fill orders for the SERIES "S" condenser, as we cannot obtain materials, but can ship the NEW SERIES "T" or the SERIES "L" condenser from stock.

SERIES "T".

No. 20	2 plate Vernier.	\$2.00
No. 70	7 plate, approx.	.0001 m.f.	\$2.35
No. 130	13 " "	.0002 m.f.	\$2.75
No. 170	17 " "	.0003 m.f.	\$3.15
No. 230	23 " "	.0005 m.f.	\$3.60
No. 310	31 " "	.0007 m.f.	\$4.30
No. 430	43 " "	.001 m.f.	\$5.25
No. 630	63 " "	.0015 m.f.	\$7.50

Include postage for one pound to your city.

PRICES

SERIES "L".

No. 2300	23 plate, .00075	\$6.00
No. 4300	43 plate, .0013	\$8.00
No. 6300	63 plate, .002	\$10.00

Include postage for two pounds.

Prices include knob and pointer and mounting screws. Specify whether brass or nickel pointer and screws, and thickness of your panel.

Either style of condenser, fitted with indicating dial at additional cost of 75c.

THE WIRELESS SHOP

511 West Washington St.

A. J. EDGCOMB

Los Angeles, Cal.

A Logical Development



The latest advance in short wave radio apparatus.

After spaced winding coils for long waves, the next logical step is to the short wave variometer, wound in this way.



As usual, the C. R. L. leads in making this step.

Our new Lattice Variometers meet every need of the super-efficient short wave regenerative circuit. Smaller air space, more compact construction, higher efficiency, lower resistance, lower capacity and wider range are all accomplished with these new lattice variometers. Furnished complete with all bearings ready for mounting on panel.

Type CRL-10 Lattice Variometer, 200-600 meters, \$7.50
(Complete with 3" dial and knob as shown)

Cabinet Mounted Types—prices on application

Dealers—write for our proposition on these variometers. Our new Bulletin O-20 describes these instruments in detail.

CHICAGO RADIO LABORATORY, 1316 Carman Ave.—5525 Sheridan Road, (92N)
Chicago, Illinois, U. S. A.

Electron Power Tubes and Some of their Applications

(Continued from page 275)

excessive plate current. One cause of this is the oscillation of the tubes at a very high frequency, the value of which is determined by the capacity between the electrodes and the inductance of the leads to the grid and plate. In order to avoid these occasional abnormal plate currents it has been found advisable to insert in the grid circuit of a few of the tubes a very small inductance of only a few microhenries value. This precaution prevents the operation of the bank of tubes at this ultra frequency. Such a coil is inserted in the grid circuit as near the grid terminal of the one or two tubes as possible.

Where a considerable number of power tubes are operated in parallel the total plate impedance may reach a rather low value of the order of a few hundred ohms. Also at very high frequencies as small an inductance as 10 microhenries is closely comparable to the tube impedance, and therefore under these two conditions of high frequency (1,000,000 cycles or more) and low total plate impedance it is important that the total plate impedance be as far as possible localized in the tubes and output transformer. Ten or fifteen feet of plate circuit wiring may have a very appreciable effect under these conditions.

For this reason it is usually advisable to bridge the d. c. power leads by a capacity as near the tubes and output transformer as practical; this capacity, of course, to have an impedance (at the frequency used) low in comparison with the tubes.

RADIO TRANSMITTING SETS.

Brief descriptions and illustrations of pieces of apparatus used in the application of pliotron power tubes to various fields, follow.

Description of Power Tube

In Fig. 5 is shown a radio transmitting set arranged for radio telephony or either continuous wave or modulated wave telegraphy. Six Type P pliotrons are used, and for continuous wave telegraphy a maximum antenna radiation of 12 to 15 amperes is obtainable in a six-ohm antenna.

A plate voltage of 2,000 is used, obtained from a double commutator direct current generator of $3\frac{1}{2}$ kw. capacity. Because of this high voltage the set is completely screened in. To gain access to the set it is mounted on wheels running on rails in the supporting frame and when pulled forward to the open position as shown in Fig. 5 all circuits to the set are disconnected. This is following the modern engineering practice of removable switchboard panels of the truck type.

The particular set illustrated is equipt for five wave lengths, any one of which may be instantly put into use by a shift of the dial lever switch to the right of the panel.

It will be noted that there are four adjustments for each wave length. These adjustments correspond to those previously outlined.

(1) Adjustment by change of antenna inductance to the exact wave length desired.

(2) Adjustment of transformer ratio between the plate circuit of the tubes and the antenna circuit.

(3) Adjustment of grid excitation voltage by:

(a) Coupling of grid coil.

(b) Amount of inductance in grid circuit.

Means are also provided for conveniently adjusting the value of grid resistance (R_g of Fig. 4) which controls the value of non-

(Continued on page 320)

NOSTAT

"Conquerer of Static"

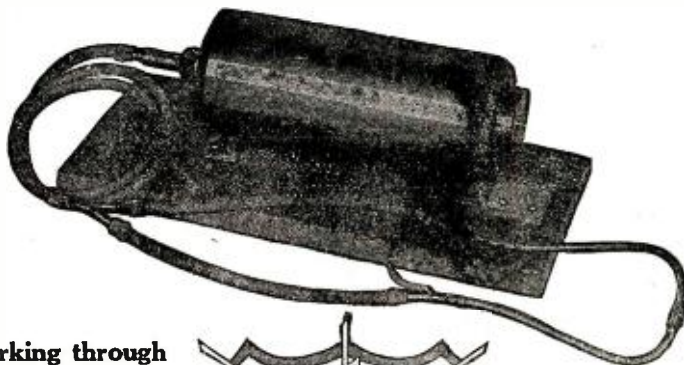

For working through
(QRN) or (QRM)

For sale by Dealers
or direct



The one piece of
Radio equipment
you can not afford to
be without.

NOSTAT COMPANY
118 St. James Place
Brooklyn, N. Y.

REAL RADIO APPARATUS

Distributors—De Forest, Murdock, Grebe, Clapp Eastham Apparatus. Perfection Tuners and Condensers. Benwood Rotary Quenched, Honey Comb Coils, Better "B" Batteries.

Phila., "Radisco Agency"
The First Wireless School in America.
Established 1911
Day and Evening Classes.
Correspondence Course.

**PHILADELPHIA SCHOOL OF
WIRELESS TELEGRAPHY**

Parkway Bldg., Broad and Cherry Streets

Headquarters for Grebe Apparatus in
Philadelphia Territory.



A \$2.00 bill will bring you interesting reading and worth while ideas for many months to come. Bound volume No. 1 of Radio Amateur News, \$2.00 plus postage. Experimenter Publishing Company, 236a Fulton Street, New York City.

A New Radio Production TURNNEY SPIDER-WEB INDUCTANCE

EMBODIED IN A SMALL UNIT

<i>Statement:</i>	<i>Reason</i>
More Induc- tance	 <p><i>There is no magnetic leak- age in coupling. The coils being flat, the entire mag- netic area of the coil is available.</i></p>
Less Distributed Capacity	<p><i>The wire runs parallel for a greater distance and crosses itself less fre- quently than any coil known.</i></p>
Lower High Frequency Resistance	<p><i>There being no interior magnetic field or air core, high frequency resistance is reduced to a minimum.</i></p>
Occupies Less Space	<p><i>The coils are so thin that three of them occupy less than ¼ inch.</i></p>

THE WINDING
Note Angle at Crossing.
Formica Core.

Reason

The Turnney Spider-Web Unit

This unit contains three Turnney spider-web inductance coils. Two movable and one stationary. There are six binding posts permitting most any type of circuit to be used. The doors, as shown in cut, are capable of very fine adjustment and stay where they are placed. With two condensers .0005 and .001 m.f., it will respond to wave-lengths of 175 to 400 meters, and to give results such as you have not had before.

FORMICA INSULATION THRUOUT

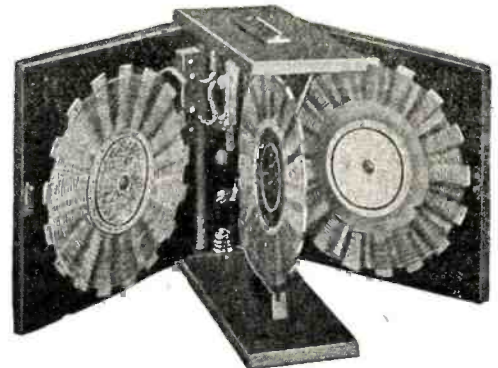

Illustration shows front of cabinet removed

Patent Pending
Dimensions, 4½ x 5 x 1¾
PRICE, \$6.00

EUGENE T. TURNNEY LABORATORIES
Radio Hill, Holmes, New York

*Further information
on request*

APPARATUS WHICH EXCELS

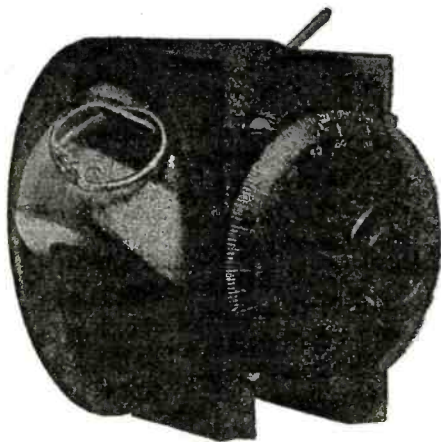

in those qualities which for 13 years have maintained its enviable reputation for reliability will be found pre-eminent in the display rooms of discriminating dealers and is manufactured by

CLAPP-EASTHAM COMPANY
120 Main Street CAMBRIDGE, MASS.

Catalog sent for 6c stamps.

TYPE Z.R.V. Variometer has unit construction with bakelite shell and hard wood ball. Has low dielectric losses and a range of inductance of 1.25 mil henry maximum to .1 mil henry minimum. It is readily used on a table or mounted on panels.

Complete with 3-inch dial and knob.....\$6.50
Without dial or knob..... 5.75

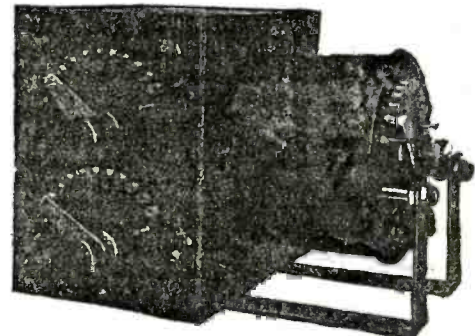

Radion Receiving Transformer
200-3000 Meters. Price \$14.00

A \$25,000 Catalog Free

Nothing like it ever published. It positively will do your heart good to feast your eyes on this wonderful book. It is a real Experimenters' book, full of photographs, bargains and surprises. The finest lines of WIRELESS INSTRUMENTS & SUPPLIES are shown, together with a full line of SCIENTIFIC INSTRUMENTS, COMPLETE LABORATORIES, CHEMICALS, SUPPLIES & GLASSWARE. It is a veritable mine for the Wireless, Chemical and General Experimenter to delve in and discover things he has long desired but could not find. In short, friends, it's impossible to describe this wonderful book. The edition is LIMITED. Send 12 cents (refunded on order of \$1.50) for YOUR copy TO-DAY, to the

Palmers Electrical Equipment Co. PALMERS, MINN.

Representatives for: Amrad, Acme, Murdock, Doron Bros., Burgess, Moorhead.

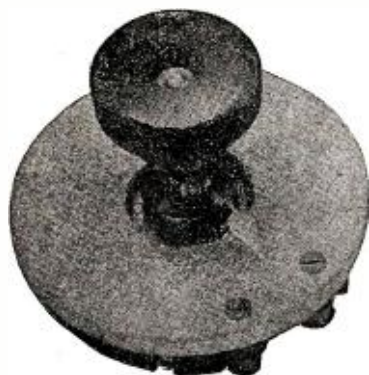

"Licensed Under Marsh Patent
No. 811859."

"SHRAMCO REO"

A 6-ohm Nickel-Chromium Resistance element mounted on electrical asbestos makes the ideal combination in a filament rheostat. Arranged for panel mounting by use of locknut. All metal parts brass. No soldered connections. Spring Phosphor Bronze blade. Even regulation and smooth operation. Complete with knob and pointer as shown. Base 3" dia. Overall height 2½". Shipping weight 1 lb. Will control 3 tubes.

Cat. No. 90—"SHRAMCO REO"—6 ohms - \$2.00 each

Special Resistance made to order

Send 5c in stamps for our catalog J.

SHOTTON RADIO MFG. COMPANY

P. O. Box No. 3

SCRANTON, PA.



TYPE 156

Vacuum Tube Socket

Adapted for transmitting as well as receiving tubes. Change over made by means of two screws in base. When set for one position protection is provided against use of tubes adapted for other position.

POSITIVE CONTACT SPRINGS

PRICE \$1.75

Send for Bulletin 901R

GENERAL RADIO CO.

Cambridge 39, Mass.

The material contained cost thousands of dollars to assemble. You can get a copy of bound volume No. 1 of Radio Amateur News for only \$2.00 plus postage. Experimenter Publishing Company, 263a Fulton Street, New York City.

(Continued from page 318)

mal operating negative grid potential. A dial switch is provided for this purpose which can be operated from the front of the panel.

On the upper one of the three panel sections are mounted various controls and instruments. The plate current ammeters for individual tubes are located in the oblong protective cases. These protective cases are used because these instruments are located in the positive or "high side" of the plate circuit. The other instruments are for plate voltage, total plate current, filament voltage and antenna radiation current.

The white circular disk to the right side of the panel is a wavemeter condenser for determining the wave length of the transmitted energy. The transmitter for telephone operation and the key for telegraphic operation are shown in operating position in Fig. 5. This view also shows two of the individual tube plate fuses mentioned in a previous paragraph.

Fig. 6 shows another multiple pliotron tube set, of simpler design, as it is equipt for only three wave lengths and has no adjustments from the front of the panel for best operating conditions.

This view shows the method of tube mounting in a spring suspended cradle so that the set may be operated under conditions of mechanical shock or vibration.

This view also shows three auxiliary pieces of apparatus, the aluminum cell protective device in the upper box, dry batteries for transmitter excitation and normal grid voltage in the lower box, and the transformer for filament lighting from an a. c. source with a center tap connection to minimize the a. c. potential effect.

Equipment for Production of High Frequency Energy.

Two views of pliotron panel equipment for supplying 50,000-cycle energy are shown in Fig. 8.

Instruments are provided for indicating filament voltage, plate voltage, plate current, grid current and high frequency output current.

Means are provided for filament regulation, a slight variation of output frequency, and for an adjustment of grid excitation voltage and ratio of transformation between tube and load.

The dial switch for this latter adjustment of transformer ratio can be seen on the left side of the set in Fig. 7.

In this same view, at the bottom of the left side, a spark gap is shown. This is for protection of the resonance condenser of the load against overvoltage.

If a large number of pliotron tubes are to be operated in parallel, it is best to arrange the design so that there are unit panels, each controlling a certain number of tubes. By combining these panels an equipment of any size can be provided for.

These unit panels contain only the pliotron tubes and their individual auxiliary pieces of control apparatus, the inductance capacities and generating equipment being separate units.

Such a unit panel for six large tubes is shown in Figs. 8 and 9.

Referring first to Fig. 8, each tube position is equipt with the following devices:

- (1) Plate ammeter, under a protective cover.
- (2) Individual filament rheostat, the control knob being located below and slightly to the left of each plate ammeter.
- (3) A plug switch for throwing in or out of circuit each filament.

A similar plug having the contacts connected to an ammeter thru flexible leads is provided. By this means the filament current of any tube may be individually adjusted to the desired value. This ammeter is lo-

(Continued on page 322)

Clear, Sharp, Readable Signals

With Brandes Matched-Tone Receivers

A set of Brandes receivers—both receivers perfectly matched in tone—is like two violins tuned in exact unison; two voices pitched in the same tone; the signals coming clear, sharp and readable, and carrying through the longest distances. This “matched-tone” feature is found in no other receivers and puts Brandes Receivers in a class by themselves.

Amateurs and Professionals

Amateurs can safely be guided by professionals in the choice of wireless outfits, and professionals all over the world are enthusiastically endorsing Brandes Receivers with which they are making wonderful records, under all conditions of service, in the United States and abroad.

Our Special Trial Offer

Buy a Brandes “Superior” Head Set and use it for ten days—putting it to the severest tests. If it doesn't prove all our claims for it and meet all your expectations, return it and your money will be refunded promptly. Brandes phones are used by U. S. Govt. experts and technical schools everywhere.



Brandes Head Set “Superior” Model; Price Complete, \$7

Send 5c for catalog G

C. BRANDES, Inc., 32 Union Sqr., New York, Room 823
Wireless Receiver Specialists

BRANDES

Wireless

Receivers

“Saco” Radio Products Are Of Superior Design and Construction

“SacoClad” Amplifying Transformers



Two Stage Audio Frequency Amplifier Type A-2, Price \$50.00



Two Stage Radio Frequency Amplifier Type RA-1, Price \$65.00



“SACOCLAD” amplifying transformers are of the totally enclosed shielded shell type. Primary and secondary windings are wound in pie sections, and assembled in alternate sections giving maximum possible coupling between primary and secondary windings.

Primary to secondary winding ratio is 1 to 5 giving a far greater voltage amplification than with existing marketed amplifying transformers. The primary impedance is equal to the filament-plate impedance of the standard market three element vacuum tube.

The flux leakage of the “SacoClad” amplifying transformer is practically zero, thus permitting the mounting of the transformers in any position without fearing coupling between successive amplifying stages and at the same time avoiding howling and squealing.

The “SacoClad” amplifying transformer is the smallest transformer made, its physical dimensions being 1 3/8” in diameter and 2” in height. It weighs 9 oz.

Price, - - - - - \$5.00

WE build amplifying transformers of any impedance and transformation ratio. Prices on application.

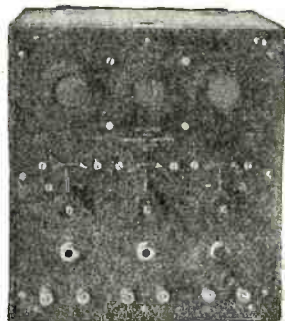

Detector and Two Stage Audio Frequency Amplifier Type DA-1, Price \$75.00



Audion Control Cabinet Type VDC-2, Price \$50

Hudson Radio Company, 182 Pulaski Street, Brooklyn, N. Y.

Manufacturers and Distributors of
SUPERIOR RADIO, ELECTRICAL AND LABORATORY APPARATUS

Sole Distributors of S. Cohen Products

Here It Is!

Lattice Wound Variometers.

Especially Designed to Improve the Short Wave Regenerative Circuit.



TYPE 12



TYPE 7

Realizing the need of a neat, compact and highly efficient Variometer for the modern receiving set, we have produced one which we feel will meet these requirements. Type 7 is assembled ready for panel mounting. A 1/4-inch hole drilled in your panel is all that is necessary to mount.

Type 12 is a complete unit, and consists of Type 7 mounted on a 4 1/2 x 4 1/2 inch Bakelite Panel, incased in a mahogany finished cabinet. Four binding posts are provided so connections can be made on any side. Both types are furnished with a standard 3-inch dial and knob, making a very attractive instrument.

PRICES Charges Prepaid
Type 7G. (For Grid Circuits) \$7.50
Type 7P. (For Plate Circuits) 7.50

PRICES Charges Prepaid
Type 12G. (For Grid Circuits) \$12.50
Type 12P. (For Plate Circuits) 12.50

A. W. HALLBAUER

1001 N. Lockwood Ave., DISTRIBUTER CHICAGO, ILL.

STUDY WIRELESS or LEARN TELEGRAPHY

18 Boylston St. } STUDENTS
Cor. Washington } Enter
BOSTON } ANY TIME

Results and Positions Guaranteed

Best equipped Radio School in New England. There has been a Telegraph School at 18 Boylston St. for over 18 years.

Send for free literature.

MASSACHUSETTS RADIO AND TELEGRAPH SCHOOL

R. E. Trop

Tel. Beach 7168

G. R. Entwistle

A-P VT Electron Relay and A-P VT Amplifier, Oscillator

In an effort to cut down the high cost of radio and to gain the confidence and good will of all progressive amateurs, we are offering these special prices.

A-P VI Electron Relay Detector

List price \$8 Our price \$5.50

A-P VT Amplifier, Oscillator

List price \$7 Our price \$6.75

The A-P VT Electron Relay is designed to be used as a detector and is equipped with the Shaw standard four-prong base. The use of a large plate and grid results in maximum signal strength and highest operating efficiency.

The A-P VT Amplifier, Oscillator was designed by Naval radio experts. It is without a doubt the most efficient amplifier on the market. A combination of an A-P VT Electron Rotary as the initial detector or oscillator with two or more A-P VT tubes as amplifiers is the ideal receiving combination for long distance reception. "Use the tube the Navy uses."

Refer to the advertisement of the Atlantic Radio Supplies Co. and Pacific Radio Supplies Co., in this issue, for the illustration and further information on these well known tubes.

Guaranteed by us and the distributors of the *Morsehead Laboratories*.

The Kehler Radio Laboratories
901 W. First St., Abilene, Kans.



Learners "HYTONE" KEY AND BUZZER SETS

With Code and Instructions.
Easily tuned buzzer (2 adjusting screws), silver contacts.

PRICE \$1.75

WITH FLAT SPRING KEY \$1.25

Buzzers, unmounted \$0.50

Lever keys unmounted 1.00

High grade lever type sending key, Bakelite base and knob 1.50

Amateur Radio Builders Handbook, by R. U. Clark, 3rd; price 1.00

(All postpaid)

AJAX ELECTRIC CO.

Palmer St. Cambridge, 33, Mass.

(Continued from page 320)

cated in the center of the panel and the plug is in its holder near the lower right-hand corner of the panel.

Referring now to Fig. 9:

(4) Individual plate fuses are provided, the white porcelain fuse blocks showing plainly on the back of the panel.

All filaments, grids and plates are each connected in parallel and brought out to terminal posts mounted at the rear of the framework. Such units are used for either amplifier or oscillator equipment.

A typical power control panel for use in connection with the above unit is shown in Fig. 10.

From left to right the instruments are:

Filament volts, filament amperes, plate volts (in hecto-volt scale divisions) and plate current in amperes. The left switch is for the field circuit of the filament generator and the right switch for the separately excited field of the high voltage d. c. plate source generator.

A high voltage plug switch is used in the plate circuit to absolutely disconnect the high voltage source to insure safety when handling the circuits.

The lower left-hand rheostat knob is for filament voltage adjustment and the right-hand rheostat knob is for plate voltage adjustment. In general, therefore, filament control is on the left and plate voltage control on the right.

On the rear of the panel is located the rheostats, plug switch mechanism, fuses, voltmeter resistances and terminals.

Power Tube Amplifier Equipment

A panel equipment of this type containing thirty pilotron power tubes is shown in Figs. 11 and 12. The tube panels are made up on the unit plan previously described.

In Fig. 11 the power panel is the right-hand one and contains instruments and control apparatus for filament and plate sources of supply.

In this equipment forced cooling is used because of the large number of tubes in close proximity. The blower and air ducts are plainly shown in Fig. 12.

This equipment operates normally with a total plate electron current averaging about direct-current plate voltage of 2,300, the two amperes.

New Amplifying Apparatus

(Continued from page 277)

In the two stage amplifier circuit shown in Fig. 2, the automatic control is used in still another manner. The operator using this instrument will find that provision has been made for controlling the filament circuit of the external detector insertion of the plug into the first jack labelled "Det." causes the delivery of filament supply current to the posts labelled "Fil. Det." Thus full automatic control is obtained for the receiver.

The Short-wave Regenerative Receiver, a wiring diagram of which is shown in Fig. 2, embodies the complete automatic control described previously and in addition there has been provided a special circuit opening jack which cuts off the detector tube filament supply current when the amplifiers are being used in conjunction with external detector apparatus.

LONG DISTANCE WORK

Mike—"I heard Lyons last night!"
Ike—"Did you? Gee whiz!"
Mike—"Yeh, at the Zoo."—J. Fardon and A. Ludeke.

Supremacy

If you are satisfied only with the finest
—there is but one answer; the



CR-6

**Short-Wave Regenerative Receiver
and
Two-Stage Audio-Frequency Amplifier**

Complete in every detail, as near perfection in design and construction as is humanly possible, the CR-6 sets a new standard for ease of operation and achievement.

We have built into the CR-6 our ten years' experience in the manufacture of the best in Amateur Radio Apparatus. We back it against any other Receiver in the Amateur field.

The CR-6 must be seen and inspected to be appreciated; ask your dealer to show it to you. If he doesn't carry it in stock, just drop us a postal card—mentioning his name—for catalogue.

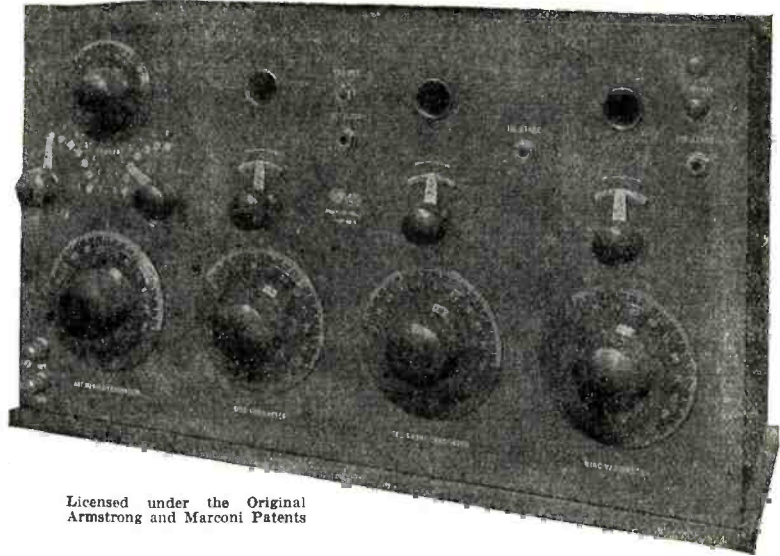

Licensed under the Original
Armstrong and Marconi Patents

A. H. GREBE & CO., Inc., 72 Van Wyck B'vd., Richmond Hill, N. Y

Better Apparatus at Lower Prices

is making our business grow by leaps and bounds. We have the most complete stock in the country ready for the big fall rush and are in a position to make

PROMPT DELIVERY ON ALL ORDERS

O COPPER AERIAL WIRE
50c per 100 Feet

Another large shipment of this excellent solid copper wire has just been received by us. The gauge is No. 14 and the wire runs 80 feet to the pound. We also sell No. 12 gauge at 80c per 100 feet. This size approximates 50 feet to the pound.

A few of the items you can save on

- Esco tested Galena, per sack 25c
 - Esco tested Silicon, per sack 30c
 - Panel type rheostat, shipping weight one pound.....\$1.00
 - 4-prong V.T. socket on base, shipping weight one pound..... \$1.50
 - Slightly used telephone plug and jack, shipping weight 4 ounces, complete 85c
- AudioTrons, Mooreheads and Marconi Bulbs, immediate delivery.

Cash in registered letter, check or money-order must accompany all orders. If shipment by parcel post is desired include postage, otherwise material will be shipped by express collect.

Our illustrated catalogue of 48 pages is now ready. 15c in stamps will secure a copy. This amount will be credited on your first order for \$1.50 or over.

Electrical Specialty Company

Dept. R—48-50 South Front St., Columbus, Ohio
Dept. R—20 North 9th St., Philadelphia, Pa.

TWO STORES FOR YOUR CONVENIENCE

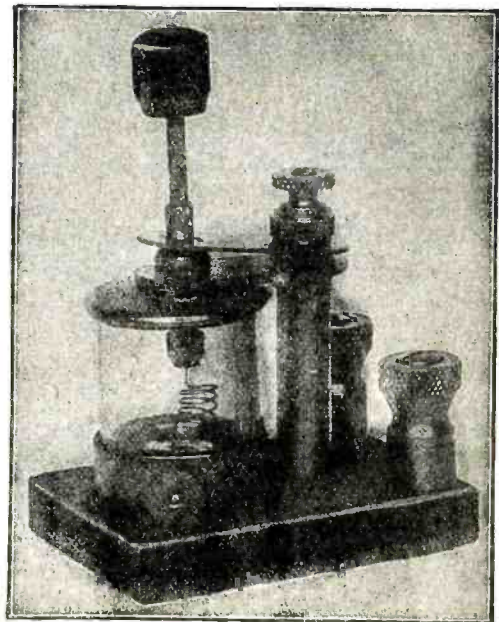

Weather Proof Crystal Detector

The type of the detector illustrated is being sold at prices ranging as high as \$4.50. Our price is \$2.80. This instrument is absolutely dust and moisture proof. The crystal, which is one of galena mounted in a block of Woods metal, is encased within a glass cylinder rendering it impervious to atmospheric conditions. Has ball and socket joint. Shipping weight 1 lb Price \$2.80.

DECIDE NOW

to become a **radio operator**. Our course prepares you quickly and efficiently for a first grade commercial license and position paying \$125 a month and expenses. Individual instruction. Moderate tuition rates. Our course of instruction best available anywhere.

Write today for descriptive booklet giving full particulars about our course.

Y. M. C. A. RADIO SCHOOL

MARCY AVE., NEAR BROADWAY

Brooklyn, N. Y.

Telephone, Williamsburg 3800

CERTAINLY WE HAVE A-P-VTs

Immediate Deliveries



- A-P Electron Relay Detector **\$6.00** each
- A-P VT Amplifier Tube **7.00** each
- A-P Transmitter Bulbs ^{5 Watt} _{Size} **7.50** each

WRITE FOR RADIO CATALOG No. 2

Mail orders promptly attended to

DOUBLEDAY-HILL ELECTRIC COMPANY

715 12th Street N. W.
WASHINGTON, D. C.

RADIO DEPT.—Desk B

719-21 Liberty Ave.
PITTSBURGH, PA.

MONEY for You Add to your Salary—Make extra Pin Money
Start a lucrative business of your own.
Spend an hour each day taking subscriptions for the "Radio News." We'll pay you well and you'll enjoy the work. Write for full particulars. Circulation Dept., RADIO NEWS, 236A Fulton St., N. Y. City.

Canadian Amateurs

BUY your Radio Apparatus
in CANADA

and save \$\$\$\$

- Murdocks No. 55 Phones
- 2000 Ohm \$6.00
- 3000 Ohm 7.25
- Rheostats panel mounting 1.35
- Series Parallel Switches. .75
- Contact Points, per doz. .30

Radisco Agents
Tresco Condensers

*Our new Catalogue is ready,
send 5c to cover postage.*

THE VIMY SUPPLY CO.
567 College Street
TORONTO, ONT.

The Livest Catalogue IN AMERICA

Our big, new electrical cyclopedia No. 22 is waiting for you. Positively the most complete Wireless and electrical catalogue in print today. 80 Big Pages, 300 illustrations, 200 instruments and apparatus, etc. Big "Treatise on Wireless Telegraphy." 20 FREE coupons for our 160-page FREE Wireless Course in 20 lessons. FREE Cyclopedia No. 22 measures 6 in. x 9 in. Weight ½ lb. Beautiful stiff covers.



Send 10 cents in stamps or coin for which we will send our latest Cyclopedia Catalogue No. 22 as described.
ELECTRO IMPORTING COMPANY
236a Fulton St., New York City

A New Continuous Wave Type Transmitter

(Continued from page 285)

tire filter arrangement is assembled as a unit and mounted directly on the main panel, as will be noted from the photograph showing a side view of the parts. Wavelength control is accomplished by means of a variable switch controlling the number of turns on the main inductance coil and a variable air dielectric condenser. Both of these are controlled from the front of the panel.

The mechanical layout of the entire unit is such that all of the modulator controls are placed to the right while the oscillating and wavelength controls are to the left of the panel.

Taken in all, this is an effective and well designed transmitter which should prove rather popular from an amateur point of view owing to its double purpose—that of furnishing the essentials of radio telephony and radio telegraphy transmission.

STATEMENT

Of the Ownership, Management, Circulation, Etc., Required by the Act of Congress of August 24, 1912, of RADIO NEWS, published monthly at New York, N. Y. for October 1, 1920.

State of New York
County of New York

ss. Before me, a notary public in and for the State and county aforesaid, personally appeared Hugo Gernsback, who, having been duly sworn according to law, deposes and says that he is the Editor of the Radio News, and that the following is, to the best of his knowledge and belief, a true statement of the ownership, management (and if a daily paper, the circulation), etc., of the aforesaid publication for the date shown in the above caption, required by the Act of August 24, 1912, embodied in section 413, Postal Laws and Regulations, printed on the reverse of this form, to wit:

1. That the names and addresses of the publisher, editor, managing editor, and business managers are: Publisher, Experimenter Publishing Co., 233 Fulton St., New York City, N. Y.; Editor, Hugo Gernsback, 233 Fulton St., New York City, N. Y.; Managing Editor, Pierre H. Boucheron, 233 Fulton St., New York City, N. Y.; Business Manager, R. W. DeMott, 233 Fulton St., New York City, N. Y.

2. That the owners are: (Give names and addresses of individual owners, or, if a corporation, give its name and the names and addresses of stockholders owning or holding 1 per cent or more of the total amount of stock.) Experimenter Pub. Co., 233 Fulton St., New York City, N. Y.; Hugo Gernsback, 233 Fulton St., New York City, N. Y.; Sidney Gernsback, 233 Fulton St., New York City, N. Y.; Harry Winfield Secor, 233 Fulton St., New York City, N. Y.

3. That the known bondholders, mortgagees, and other security holders owning or holding 1 per cent or more of total amount of bonds, mortgages, or other securities are: (If there are none, so state.) None.

4. That the two paragraphs next above, giving the names of the owners, stockholders, and security holders, if any, contain not only the list of stockholders and security holders as they appear upon the books of the company but also, in cases where the stockholder or security holder appears upon the books of the company as trustee or in any other fiduciary relation, the name of the person or corporation for whom such trustee is acting, is given; also that the said two paragraphs contain statements embracing affiant's full knowledge and belief as to the circumstances and conditions under which stockholders and security holders who do not appear upon the books of the company as trustee, hold stock and securities in a capacity other than that of a bona fide owner; and this affiant has no reason to believe that any other person, association, or corporation has any interest direct or indirect in the said stock, bonds, or other securities than as so stated by him.

5. That the average number of copies of each issue of this publication sold or distributed, through the mails or otherwise, to paid subscribers during the six months preceding the date shown above is (This information is required from daily publications only.)

EXPERIMENTER PUBLISHING CO., Inc.,
HUGO GERNSBACK President.

Sworn to and subscribed before me this 6th day of October, 1920.

[SEAL] HELEN T. NEARY.
(My commission expires March 30, 1920.)

History of The Honeycomb Coil

(Continued from page 304)

fifteen years, I would like to ask why with all the agitation for a coil of this type in Government circles and elsewhere, a coil of the Honeycomb type was never wound until I went to Providence and showed Mr. Giblin the type of winding I wanted?

A MARCONI IN THE MAKING.

Son—"Say pop, can pictures be taken with aeriels?"

Pop—"No. What makes you ask such a question?"

Son—"Why I just saw an aerial picture taken above New York."—*John Ginetti.*

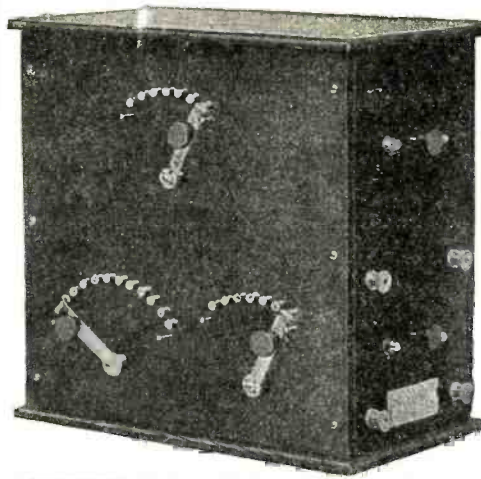

Great Improvement for Long Waves

"I consider your New Long Wave Tuner a marked improvement over older type. The elimination of the extra cumbersome coils and the easy and selective tuning, makes this new apparatus a very satisfactory receiving instrument."

Theodore W. Case, Case Research Laboratory, Auburn, N. Y.

Send 2-cent stamp for new bulletin

Colby's Telegraph School
AUBURN, N. Y.

THE G. A. Store, at St. Nicholas Avenue and 184th St., is open every evening until nine o'clock.

- Grid Condenser - 35c
- Phone Condenser - 35c
- Grid Leak Condenser 50c
- Add 5c for postage

If You Think

That you must spend a dollar for a fixed condenser, or two dollars for a grid condenser and leak, the G. A. type will show you that, this time, you are mistaken. You can buy G. A. Condensers at any of the large stores.



The General Apparatus Co., Inc., 570-N. West 184th St. New York City

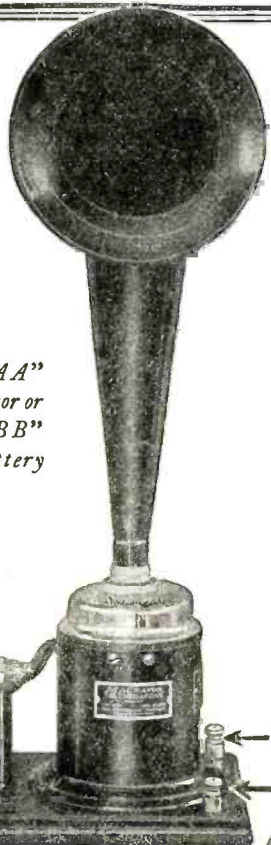

CONNECT "AA" to your detector or amplifier, and "BB" to a 6-volt battery

MAGNAVOX

RADIO TELEMEGAFONE

Type R-1 with small horn \$75

Type R-2 with large horn \$93

DEALERS

- Atlantic Radio Co., Boston, Mass.
- Doubleday-Hill Electric Co., Pittsburg, Pa.
- Pacent Electric Co., New York, N. Y.
- Intermountain Electric Co., Salt Lake City, Utah.
- Southern Electrical Co., San Diego, Calif.
- Magnavox Representative, 606 Mutual Life Bldg., Seattle.

Ask for Bulletin 21020

THE MAGNAVOX COMPANY

2701-2765 EAST 14TH STREET
OAKLAND, CALIFORNIA

???? \$12.00 ???? ?



That is the price which puts an EV-RA-LAB Type "D" Audion control Unit at your service. May be used with Audio-Tron or tubes equipped with standard base. 45-V. "B" Battery tapped for above Panel \$2.75 extra. Other EV-RA-LAB bargains as follows:

- Single Stage Amplifier, - - \$22.50
- Two Stage Amplifier, - - 40.00
- Det. and Single Stage Amp. - 32.50
- Det. and Two Stage Amp. - 50.00

Let us show you some real SERVICE on any of the following companies' apparatus: Acme, Radisco, Chelsea, Tresco, Murdock and others. Give us a trial.

EVANSVILLE RADIO LABORATORY
1103 S. Third St. Evansville, Ind.

What Are You Going To Do About It?

(Continued from page 302)

ment he should not expect a great deal, in fact he should not be on the job at all. The harder the examinations and the nearer they come to being replicas of actual operation under severe conditions the better it will be for every one of us in the long run, even though it does mean that we have to pour over some books now and again in order to keep pace with the times.

Inefficient and improperly trained radio men should be a thing of the past, as such a man cannot possibly cope with heavy traffic under the fire of interference, no matter what the schools claim. The same applies to the fellow who horned in on a license after serving some time on a temporary permit. The ocean is covered with "lids" and the only way to get rid of them is to examine the whole bunch all over again and weed out the undesirables. You can talk your head off about a strong organization, but the only way in which we can ever expect to place ourselves in the proper light is by the direct application of the golden rule: *Step out of the liability column and be an asset.*

A RADIO XMAS

Make this holiday season a radio one, buy your apparatus now before the demand exhausts the supply on hand. We fill all mail orders promptly—and post-paid too.

- .0005 Condensers Grid } each
- .0013 Condensers Stopping } \$.35
- 2,000 Ohm Phones 4.50
- 3,000 Ohm Phones 5.50
- Adams-Morgan Rheostats 1.75
- Genuine Auditrons 6.00
- Radio Service Audion control panels 6.50
- Small Portable Sets 7.50
- Grebe Detector and 2 step Amplifier 65.00
- Grebe CR2 48.00
- Grebe CR3 Special 60.00
- 22½ V. "B" Battery 1.25
- ROEH Detector 17.00
- RORE Amplifier 25.00
- Corwin Dials 1.80

RADISCO AGENTS

- Radisco Coils—
- LRD 40.....\$0.70 LRD 175.....\$1.15
- LRD 100..... 0.95 LRD 550..... 1.65
- LRD 325..... 1.40 LRD 1200..... 2.65
- LRD 750.....\$2.00

- Tap Coils—
- LRD 325 3...\$1.70 LRD 750 3...\$2.80
- LRD 1200 3...\$2.90

- Coil centers plainPair \$0.25
- Coil mounting for Radisco Coils.... 6.00

Send 10c for catalog

Open Evenings Until 9:30 P. M.
KELLY & PHILLIPS
312 Flatbush Avenue, Brooklyn, N. Y.
Telephone Sterling 2380



NEW YORK BOSTON

THIS school offers a thorough course in all branches of Radio Telegraphy. Prepares you thoroughly for Government examinations, Merchant Marine, Commercial Land Radio, Radio for Railroads, Radio for Aerial Mail Service, Etc. Elementary and Advanced Classes, day and evening sessions.

Nautical Academy established 1804;
Radio School, 1920

CAPTAIN F. E. UTTMARK, Principal
Write, call or phone for illustrated booklet.

8 STATE ST., NEW YORK, N. Y.
Facing Battery Park, N. Y.
Telephone, Bowling Green 8079

For Radio — UTTMARK'S — For Navigation

DEVELOPMENT OF ELECTRON TUBES

By Marius Latour

The search for a relay without inertia that would amplify very weak currents has long occupied both physicists and engineers. Nor is the idea of utilizing the electrical phenomena in exhausted tubes containing an excited cathode (in form of an auxiliary arc or an incandescent filament) of very recent date. In recent years, however, the electron tubes have been developed to the point where they have assumed great commercial importance, pre-eminently in communication service, but also in the rectification of small and moderate currents and in measurement work.

The Austrians von Lieben and Reids, undoubtedly influenced by the work of Latour and Weintraub, have, in 1911, designed three-electrode amplifiers containing an atmosphere of mercury vapor. The engineers of the General Electric Company in America have more recently constructed amplifiers in which the vacuum, on the contrary, is pushed as far as possible. The Western Electric Company has, on the other hand, developed amplifiers in which the vacuum is only moderate, but which contain an oxide-coated filament for the purpose of increasing the thermionic emission and consequently the conductivity of the space.

Finally, in the years preceding the war. German as well as American engineers published a number of different circuit connections for the three-electrode amplifier. These publications undoubtedly anticipate some of the work done in France during the last few years. One must not forget, however, that the amplifier of audion type was little known in 1914 and that an exact theoretical study permitting from an engineering point of view the rational use of the apparatus was not at hand. It was under these conditions that the French Military Radio-Telegraphy Department, under the direction of General Ferrie, developed the amplifiers needed in its service. Mr. Abraham soon determined all the characteristics of the tube and all its useful constants. A special type was devised which offers the advantage of simplicity, ruggedness and cheap manufacture.—*Electrical World*, Sept. 11, 1920.

Radio Apparatus

The Mutual Purchasers Association offers radio amateurs membership that will bring them co-operative saving on all purchases of radio and electrical apparatus.

3000 amateurs are now buying everything they need through this association, getting fast service and co-operative buying on the goods of all the radio houses of standing, advertised in this publication.

You can order any popular radio part advertised in this magazine from the association and secure fast service and saving.

Send stamp to Dept. 3 for details and have your name enrolled as a member of this co-operative association without cost.

MUTUAL PURCHASERS ASSOCIATION
2 & 4 Stone St., New York City

The WIRELESS EQUIPMENT COMPANY, Inc.

Furnishes all kinds of reliable radio apparatus at lowest prices. Send for latest bulletin No. 151D on new apparatus.
188-190 Greenwich St. New York

THIS MONTH'S SPECIAL

- R T S Guaranteed Tested Galena, per box 25c
- Aerial Wire No. 14, Solid Copper, per 100 95c
- Grid Condensers 60c
- Murdock Phones, 2000 Ohm..... \$4.25
- Murdock Phones, 3000 Ohm..... 5.25

Radio Testing Station
25 Sturges Street Binghamton, N. Y.

RADIO APPARATUS

built to your specifications. Raw material and parts. Machine work done for experimenters. Get my prices before buying elsewhere.

A. C. PENFIELD
CONNEAUTVILLE, PA.

HERE IT IS!

We Have It.
Just What You Want.
Anything in Wireless.
Circular sent upon request.
S. G. RADIO CO.
644 East 15th Street Brooklyn, N. Y.

Gleaned From the Radio Service Bulletin

IMPROPER USE OF STORAGE BATTERY

It has been brought to the attention of the Bureau that operators have been using auxiliary source of power (storage battery), for the operation of audions.

The auxiliary source of power must not be used for any purpose other than that required by section 1, act of June 24, 1910, amended July 23, 1912.

The battery must be kept fully charged and ready for immediate use.

Any defects in the battery or any other part of the radio equipment should be reported to the master of the vessel immediately.

Such neglect of duty on the part of operators may be considered sufficient cause for the suspension or revocation of their license.

INTERNATIONAL RADIO TELEGRAPH CO.'S RATES

The International Radio Telegraph Co. has been authorized to charge 10 cents per word (with no minimum number of words), for transoceanic and coastwise ships which ply between ports, one of which is more than 200 miles from New York, effective October 1, 1920. This rate applies to the Newport, R. I., New London, Conn., and Brooklyn, N. Y., stations of the above-named company.

NEW INTERNATIONAL ABBREVIATIONS

This office is informed by the Berne Bureau as follows:

Abbreviation—

QTC
Question—

Have you anything to transmit?

Response or advice—

I have something to transmit.

I have one or more radiograms for —

New signification of abbreviation QRU

QRU—I have nothing to transmit.

I have nothing for you.

OPERATOR'S LICENSE SUSPENDED

License No. 19544, issued at Philadelphia, September 20, 1919, has been suspended for a period of three months on account of the holder of the license violating Article VI of the service regulations and the International Convention. The offending operator in this case caused superfluous signals to be transmitted.

NORMAL WAVE LENGTH

Every coast station open to general public service is required to have a normal sending and receiving wave length of 600 meters, and all general public service with ship stations must be conducted on 300, 600, or 1800 meters.

The department interprets the radio laws and the London Convention to require that every coast station, excepting general and restricted amateur, shall have a normal wave length of 600 meters for use in case of distress or emergency, and licenses issued for such stations so indicate.

The indication of a 600-meter normal wave length for a special station does not mean that the station shall use this wave length for its normal business. All radio communication, other than general public service, must be conducted on some authorized wave length other than 300, 600 or 1800 meters, but the station is required, when open and no special business is being conducted, to listen in with the receiving apparatus tuned to receive the 600-meter wave length and must be prepared to transmit on 600 meters if necessary.

The Radio Laws and Regulations, edition of August 15, 1919, page 52, paragraphs 38 to 50, inclusive, bear on this subject, and paragraph 44 provides that all coast stations shall listen in at intervals of not more than 15 minutes and for not less than

(Continued on page 328)

LEARN WIRELESS AT HOME

The Demand for Good Wireless Operators Far Exceeds the Supply

The New York Wireless Institute will make you an operator—AT HOME—in your spare time—quickly, easily and thoroughly. No previous training or experience required. Our Home Study Course has been prepared by Mr. L. R. Krumm, Chief Radio Inspector, Bureau of Navigation, N. Y. Radio experts able to impart their practical and technical knowledge to YOU in an *easy to understand* way, will direct your entire Course. The graded lessons mailed you will prove so fascinating that you will be eager for the next one. The instruments furnished *free*, will make it as easy to learn the Code as it was to learn to talk. *All you will have to do*, is to listen.

Big Salaries

Wireless operators receive excellent salaries ranging from \$125 to \$200 a month and it is only a stepping stone to better positions. There is practically no limit to your earning power. Men who but yesterday were Wireless Operators are now holding positions as Radio Engineers, Radio Inspectors, Radio Salesmen at salaries up to \$5000 a year.

Travel the World Over

A Wireless Operator can visit all parts of the world and receive fine pay and maintenance at the same time. Do you prefer a steady position without travel? There are many opportunities at the numerous land stations or with the Commercial Wireless or with the Steamship Companies.

FREE Instruments and Text Books

We furnish free to all students, during the course, *the wonderful receiving and sending set exactly as produced in the illustration. This set is not loaned, but given to all students completing the Course.*

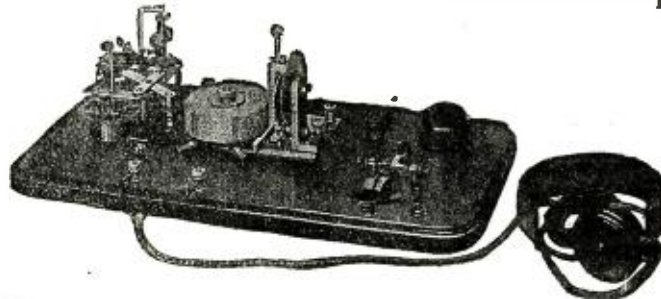

This wonderful Set for learning the Code furnished free with our Course

The Transmitter shown is the celebrated *Omniograph* used by several Departments of the U. S. Government and by the leading Universities, Colleges, Technical and Telegraph Schools throughout the U. S. and Canada. Start the *Omniograph*, place the phone to your ear and this remarkable invention will send you Wireless Messages, the same as though you were receiving them, through the air, from a Wireless Station hundreds of miles away. When you apply for your license, the U. S. Government will test you with the *Omniograph*—the same model *Omniograph* as we furnish to our students. Ask any U. S. Radio Inspector to verify this.

FREE Post-Graduate Course

A one month's Post-Graduate Course, if you so desire, at one of the largest Wireless Schools in N. Y. City. New York—the Wonder City—the largest port in the World and the Headquarters of every leading Wireless and Steamship Company.

Easy Payments

A small payment down will enroll you. We will make the payments so easy that anyone ambitious to enter the fastest growing profession—Wireless—may do so.

Send for FREE Booklet

Without obligating you in any way, send for our booklet "How to Become an Expert Wireless Operator"—it is free. Mail the coupon below, or postal or letter—but do it today.

NEW YORK WIRELESS INSTITUTE
Dept. 22, 258 Broadway
New York City

New York Wireless Institute
Dept. 22, 258 B'way, N. Y. City

Send me free of charge, your booklet "How to Become an Expert Wireless Operator," containing full particulars of your Course, including your Free Instrument Offer.

Name

Address

City or Town.....State.....



HOOK 'ER TO YER BULB

The Most Wonderful Tuner in the World for \$10.00
Add Parcel Post—Coils only, - - - 6.00

About four months ago I purchased one of your mysterious 20,000 meter tuners. And today, am copying POZ—YN—NFM—MU—LCM—IDO—OUL. Haven't had much time to sit in but the best part to tell you about this black box is that all this foreign stuff comes in on a 35 ft. aerial 35 ft. high on one end and 20ft. on the other end. I'm always ready to recommend the black box instead of any other inductance made.

(Signed) ERNEST F. SCHWACH,
1637 Parkside Ave., Chicago, Ill.

KNOCKED DOWN AND ASSEMBLED CONDENSERS

Which kind do you want. Made for panel mounting and are complete with scale pointer and knob. Used all over the world now and still going strong. No C.O.D. orders. Add parcel post. Buy from your dealer.

or and send us his name if he cannot supply you. Canadian amateurs buy from local dealers or write us for nearest dealer. Formica tops and bases. Movable plates are screwed on and not clamped.

- 11 plate knocked down.....\$1.80
- 21 plate knocked down..... 2.25
- 41 plate knocked down..... 3.20
- 11 plate assembled..... 2.75
- 21 plate assembled..... 3.25
- 41 plate assembled..... 4.25

Sold by your dealer or

TRESCO—Davenport, Iowa

Be a sport and send 5c for our Catalog. Foreign orders solicited. Canadian Amateurs buy from Canadian Dealers. All products licensed under Armstrong Patents.



(Continued from page 327)

2 minutes, with the receiving apparatus adjusted to receive a 600-meter wave length. The act of August 13, 1912, section 4, regulation 11, requires general public-service coast stations to listen in at intervals of not less than 15 minutes and for a period of not less than 2 minutes with the receiver tuned to receive messages of 300-meter wave lengths.

INDEPENDENT WIRELESS TELEGRAPH CO.'S RATES

The Independent Wireless Telegraph Co. has been authorized to charge 10 cents per word, no minimum, at their New York station (WSE) for coastwise and trans-oceanic ships. This rate effective beginning October 1, 1920.

Correspondence

(Continued from page 300)

Convention an endeavor was made to secure a talk by certain men of national prominence. Mr. Hiram Percy Maxim delivered a lecture on the possibilities of the radiophone which was well received by the amateurs on the Pacific Slope.

In the same issue of RADIO NEWS on page 175 there is a lecture printed on vacuum tubes delivered over this radiophone by Lieutenant Ellery W. Stone, U. S. N. R. F., on June 23rd, 1920.

The music that is disseminated broadcast by radiophone has been heard 700 miles away, all overland and through wooded and mountainous country and at 2 o'clock in the afternoon. Ships coming into San Francisco harbor from the Far East pick up this music over 1200 miles out and hold it continuously until reaching port.

No elaborate proposition is made within the theatre for picking up the music, there being used but a single microphone located invisible to the audience. This problem is considerably more difficult than by having music sent directly into the transmitter.

Neither a multiplicity of tubes nor a large amount of power is used, as the apparatus has been carefully engineered to give results by full utilization of latest developments in the radio art rather than by hammering the signals thru by brute force.

The results mentioned above have been obtained by a power input of less than 1 kilowatt. Certainly when you compare these results with what is known to have been achieved in foreign countries you will be justified in tacking a *nulli secundi* sign, likewise a *sui generis* label under the U. S. A. list of radio achievements.

An improved aerial construction is at this writing being installed and will possibly be completed before you receive this letter. We are operating under a temporary license, our call being 6XA, our wave length is 1425 meters. The orchestra concerts are sent out on week days at about 2.15, 4.00, 7.15, and 9.00 P. M. and on Sundays at 11.00 A. M., all Pacific time, New York time being four hours later.

With the improved aerial we are certainly going to step over the Rockies, hitting the fifth and ninth districts, and if a few of the No. 2 boys do not get us they had better get their apparatus repaired.

We recently reproduced the Sunday morning concert of the California Theatre at Letterman Hospital, located in the Presidio, with three steps of amplification, and the music received was louder than the original and fully distinct, likewise sounding simultaneously with its rendition at the Theatre and unknown to the Theatre's audience, was enjoyed by an audience of approximately six hundred convalescent soldiers at the hospital.

R. M. KLEIN,

Manager, Lee De Forest, Inc.
451 3rd St., San Francisco, Cal.

ATTENTION AMATEURS

The only practical adapter

Price \$1.50

RADISCO AGENCY

We make up sets to specifications



Made by the

AMATEUR WIRELESS EQUIPMENT CO.

1390 Prospect Ave., Bronx, N. Y.

Catalogue sent on receipt of 10c, which may be deducted from first order.



Dealers write for proposition

Radio Men—Concentrate Your Buying—

We can supply practically all types and makes of apparatus on the market. Let us quote prices on apparatus you may need. Write today.

FEDERAL RADIO & RESEARCH LABORATORY
20 Rush Street Somerville, Mass.

10,000 Printed—All Sold Out THE SECOND EDITION OF THE CONSOLIDATED RADIO CALL BOOK

Was completely sold out within six weeks after it was published. The Third Edition will be out sometime in December. Watch for the announcement of the new edition and be sure to get a copy before they are all gone.

CONSOLIDATED RADIO CALL BOOK CO.
41 Park Row New York City

IMMEDIATE DELIVERIES

LEADING MANUFACTURERS' PRODUCTS

WESTERN RADIO ELECTRIC COMPANY

ESTABLISHED

"FOR BETTER SERVICE TO THE WESTERNER"

550 South Flower Street

Los Angeles, Cal.

THIS LADY WISHES ADVICE

Editor of RADIO NEWS:

I am writing to ask your reader's advice about securing a position in the radio field.

I am a young woman, and have had a first grade commercial license for nearly three years. Last June I had it renewed and received a rating of 91.8% in my examination, the highest mark of any of the fifteen men who took the "exam" at the same time.

I had three months' experience in the Signal Corps as Radio Apparatus Inspector and was honorably discharged soon after the Armistice was signed. My work was to give the final inspection to all government orders of radio apparatus at the factory where I was stationed.

After that I was a Reconstruction Aide in the Medical Department at U. S. General Hospital No. 31, Carlisle, Pa. I taught wireless to wounded soldiers and was finally discharged at my own request, as I desired a vacation after eleven months' work.

Now I find it almost impossible to get a radio position of any kind in spite of my experience just because I am a woman. I would be willing to do anything in the radio line or go anywhere. I would like an actual operating job best, but would be willing to work in the laboratory or inspection department of a factory.

Do you think you could help me to get such a position? Would it do any good is easily adaptable to this arrangement. No if I advertised in your magazine? Would you be willing to publish this letter?

If anyone could give me some advice on this matter it would be greatly appreciated by
Miss REGINA G. TILESTON,
Box 483, Sharon, Mass.

ANOTHER "KICK"

Editor of RADIO NEWS:

I wish to take this opportunity to express my admiration for the wonderful magazine you put out in the RADIO NEWS. I have been a subscriber to your magazine in the old days of "Modern Electrics" and must say that you always put over the goods.

Let the RADIO NEWS keep up the good work and don't digress from its Radio purpose, and you will have a loyal bunch of readers. I must say that I like the name of RADIO NEWS better than the old name, as this puts the magazine on a higher level which it well deserves.

I wish you all the hard earned success you rightly deserve.

ROBERT CHANDLER,
1050 Riverside Ave., Evansville, Ind.

WHAT, AGAIN?

Editor of RADIO NEWS:

For the information of Mr. G. C. Hallett, whose letter appears in the September number of the RADIO NEWS under the heading "Who Was the First Lady 'Opr' Anyway," as well as for that of the young lady who wrote "The Autobiography of a Girl Amateur," I would like to say that the Mrs. Turner to whom Mr. Hallett refers, was not Mrs. Turner, but Mrs. Tucker. I relieved her for a few days while she was working on the "Indianapolis."

Thus, another old timer slaps down his aerial switch on Mr. Hallett.

R. B. WALLACE,
1200 Asbury St., San Francisco, Cal.

THIS BIRD HEARS "WAVES"

"I heard a ship last night."
"What was his call?"
"Didn't get it."
"Then how do you know it was a ship?"
"Why, I heard the waves."
—W. F. Lauterman.

**Announcing The New 1921 Model
RED HEAD RADIO RECEIVERS
A Triumph in Radio 'Phone Building**

The Famous
ARLINGTON
TESTED CRYSTALS
The Acknowledged
Standard in Radio
Detector Minerals.



It has been said by advanced radio physicists that vacuum tubes are no more sensitive than "very good" spots on galena. Hundreds of testimonials now in our files testify to the probability of such a statement. These letters come from users of Arlington Tested Crystals.

Arlington Tested Minerals have been on the market seven years and are sold by reputable dealers everywhere. Each crystal is individually tested and boxed in a lithographed metal container. Imitations are available but you can be assured of the original genuine crystals by looking for the signature "J. S. Newman" on each box.

- N A A Tested Galena, post-paid35c
- N A A Tested Silicon, post-paid35c

Mail Order Service

Our mail order department is prepared to make practically immediate shipment on all radio apparatus of the following standard makes:

- | | |
|----------|------------|
| DeForest | Thordarson |
| Murdock | Acme |
| Signal | Mignon |
| Grebe | And Many |
| Amrad | Others |
| Bunnell | |

Mail your orders to us and be assured of real radio service.

3000
ohms



\$12.50
set

The new "Red Heads" are ready. Rugged and sturdy as ever—but even more exquisitely sensitive. The same handsome appearance—but wound to a higher resistance.

The same guarantee—we, not you, assume the risk.

For five years Red Head Receivers have held an enviable position in the radio field.

The new model will maintain their popularity.

Detail: 1,500 ohms each receiver (3,000 ohms per pair); cast aluminum backs; genuine Bakelite ear caps, re-enforced cords with strain loops and posts; phosphor bronze head bands. Money refunded if Red Heads don't please you.

Price, prepaid anywhere, \$12.50 complete set.

Catalogues Free on Request

The Newman-Stern Co.

1874-76 East Sixth Street

Cleveland, Ohio

These Distributors can supply "Red Heads" and N A A Minerals to Dealers and Experimenters:
DeForest Radio Telephone and Telegraph Co., New York. J. H. Bunnell Co., New York.
Signal Electric Co., Menominee, Mich. Lee DeForest Co., San Francisco, Cal.

Audion Control Unit only \$15.00



The K. & G. Wireless Supply Co., in its efforts to place technically correct and reliable wireless apparatus well within the price reach of critical amateurs, announces its new Audion Control Unit, Type A1. This new unit is absolutely reliable and can be used with every known circuit. It is designed and built for exacting service. It combines the very latest ideas in design with the best of material and workmanship. The cabinet, 8x5½x6", has a highly polished mahogany finish and with its well mounted bakelite panel will add much to the attractiveness of your station. The unit contains these instruments: vacuum tube socket (for standard 4-prong tube), filament rheostat (10 ohms), grid condenser, grid leak, and filament switch. Panel has binding posts, suitably engraved in white, for secondary, tickler, phones, and filament battery. Whole back of cabinet swings open on hinges and thus permits easy insertion of tube and batteries and complete inspection of the interior. Efficiency guaranteed, or money refunded.

Price \$15.00, without tube or batteries. If your dealer can't supply you, order direct. Dealers: Write for proposition.

K. & G. WIRELESS SUPPLY CO.

Dept. 16B, 152 Chambers Street

New York City

Have you something to sell or exchange? A classified ad in Radio News will reach 40,000 for only 4 cents a word.

CLAPP-EASTHAM APPARATUS

IMPROVED ANTENNA SWITCH No. 658

For the amateur who desires an efficient and smooth working transfer switch we are pleased to recommend the one shown in the accompanying cut. This switch may be used to transfer the antenna from the receiving to the transmitting apparatus and when in the latter position will close the transformer power circuit, ground the receiving set and start the rotary gap. This instrument is of grained bakelite thru-out, all metal parts being finished dull nickel. Price \$12.50



ROTARY SPARK GAP No. 741

This Rotary Gap comprises a substantial iron casting, finished in black, which completely encloses the sparking electrodes, largely eliminating the objectionable noise of the spark and removing the blinding flashes which are quite injurious to the eyes. The motor for driving the rotating element is of the highest grade variable speed, series wound motor obtainable and, unless otherwise specified, is wound for 110 V AC 60. All electrodes are of pure copper, the rotating member being patterned something after a circular saw, rotating backwards so that there is an instantaneous break and no tendency for the spark to "drag." Variations of from approximately 2,000 to 6,000 rpm are possible and the rotor has sixteen teeth or sparking points. Price, \$50.00



BALANCED VARIABLE CONDENSER No. 800

The increasing tendency toward compactness of construction in receiving and transmitting sets requires a condenser occupying but a small amount of panel space. Requiring but 3 1/2 inches of panel when mounted and being supplied in capacities of .0006-.001 and .0015 mfd. this condenser is especially suited for panel mounting. In addition to the above advantages the balanced design of the plates renders its use in a horizontal position possible. The construction is of aluminum thru-out with hard rubber insulating bushings in the top and bottom bearings. This condenser is normally supplied unmounted with scale and knob. When desired for laboratory use a heavy brass oiltight case may be obtained at an additional cost of four dollars. No. F800A, .001 mfd., \$9.50; No. F800B, .0015 mfd., \$11.50.

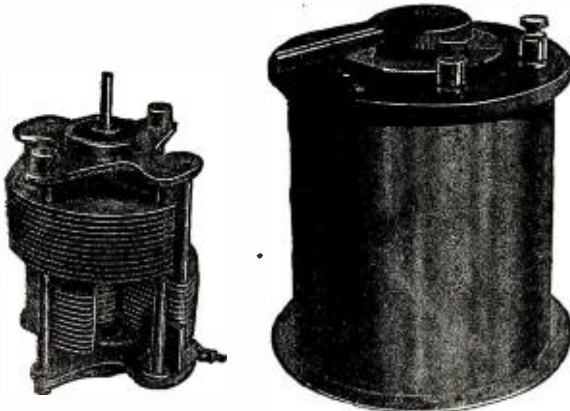

plied unmounted with scale and knob. When desired for laboratory use a heavy brass oiltight case may be obtained at an additional cost of four dollars. No. F800A, .001 mfd., \$9.50; No. F800B, .0015 mfd., \$11.50.

SEND FOR OUR No. M-12 MANUAL OF WIRELESS TELEGRAPHY



You should have it even if only superficially interested. Around about you every day you read of some marvelous occurrence in which wireless played a distinguished part. It may not be entirely clear to you. The Manual will explain it. To the student of Wireless Telegraphy, the Manual contains much that is indispensable to a proper understanding of the art. A good portion of this is now published for the first time—and consists of formulae, tables, diagrams, Federal regulations, codes, diagrammatic instruction for installing, maintaining and operating wireless stations, together with a complete list of up-to-date wireless instruments and accessories. The Manual contains 200 pages, fully illustrated on high-grade paper stock with a two-color cover.

We ask twenty-five cents (\$0.25) for it—give you a coupon receipt which can be applied on any order amounting to Five Dollars (\$5.00) or more.

Do not wait until some other time, but sit down now and send your name and address, and get one of the most complete, comprehensive and reliable wireless pamphlets published.

MANHATTAN ELECTRICAL SUPPLY CO., Inc.

17 Park Place
NEW YORK

114 S. Wells Street
CHICAGO

1106 Pine Street
ST. LOUIS

604 Mission Street
SAN FRANCISCO

HAVE YOU SOMETHING TO SELL OR EXCHANGE?

A classified ad in Radio News will reach 40,000 at a cost of only 3 cents a word. Try one in the next issue!

RADIO AMATEURS

Judge for yourself what kind of RADIO equipment you shall purchase, but remember that any piece that you select can be procured from us at a saving to you provided it is dependable and efficient in operation.

We will be glad to build equipment of special design to meet your requirements if you can not find what you desire in standard equipment. Let us hear from you. We want your name and address so that we will be able to keep in touch with you, and we will send you descriptive bulletins of new apparatus together with our price list.

Northern Radio Laboratory
Specialists in Radio Apparatus
111 Main Street
Clyde, Ohio.

MEMORIZE CONTINENTAL CODE ALMOST INSTANTLY

Save the many weary weeks now spent pounding the Code into your head with telegraph key. Memorize Code before using key and subsequent progress will be rapid. Get Wise. Ask for free copy "What They Say About It." Many report having memorized entire Code in ONE HOUR and you can do the same. Avoid the labyrinth of the Code in its ABC sequence. Our Short Cut Method is the straight path to quick success.

Complete Chart and full instructions
FIFTY CENTS

C. K. DODGE

Box 200
Mamaroneck, N. Y.

The Alexanderson Alternator

A paper presented before the Associated Demented Radio Engineers at Ipswich on July 23rd

It has been generally conceded that the most essential requisite for reliable long-distance radio communication is a wave of the undamped variety. Several methods are in use for the generation of undamped waves, and the most successful of these is the Alexanderson Radio Frequency Alternator.

In the first place, this machine is manufactured by the General Electric Company, and they are manufactured in such large quantities that the G. E. Co. had to find a simplified name for them, so they therefore called them just alternating current generators, and painted them red. Now this bright color has a very important action on the operation of the machine, although very few people are aware of it. It is generally understood that ultra-violet rays are produced by a very high-frequency current. There is a horn gap situated on the top of the alternator. This horn gap is so located that it is in the center of the magnetic field, and is completely surrounded by red.

Now, Professor Snitchblossom, of the Royal Botanical Museum, tells us in his "Twenty Years Among the Bugs" of the great attraction which the color red has for insectivorous life. Now the frequency of an insect's wing is well-known to be among the thousands. A piece of cheese is placed on the horn gap in such a position that the insects will fly around it. In their frenzied desire to get at the cheese their little wings generate an oscillating current of tremendous frequency. This current in turn has a refractory action on the violet red color of the machine and thus produces ultra-violet rays. These rays are collected in a large basket by the Alternator attendant and are turned over to the Shift engineer. The Shift engineer shifts the rays about, sorts them out according to polarity, weighs them, makes an entry on the log sheet, and then dumps them into a wash-tub-looking affair called a magnetic amplifier.

Now this magnetic amplifier is one of Mr. Alexanderson's most important inventions. It consists of a complete space in the form of a circle, filled with two sets of vacuums placed at right angles to each other. These vacuums act inductively, therefore, on the field of the alternator and cause an output onto the antenna. The antenna used with the Alexanderson system is called the multiple-tuned antenna. This is undoubtedly the only antenna in the world which is an aid to politics. An indication of this fact was seen when President Wilson and Secretary Daniels used it in their "Heart to Heart Talks for Wayward Democrats." This antenna, ever since its use by President Wilson in his transatlantic telephone conversation, has had the peculiar property of doubling and even trebling the amperes a good many times. A complete understanding of this phenomena is not available at the present writing, but it is hinted that Christian Science radiation meters are used at some stations.

Probably the most interesting and creditable part of this system is the device used to increase the efficiency of the alternator. Credit for this device is due a Mr. William Clark, of Newark, New Jersey, U. S. A. Mr. Clark immediately realized the value of trained bugs to the Corporation, so he started along these lines. He figured that after the common variety of June bugs flew across the path 347 times it was powerless to resist the temptation to stop and alight on the cheese. Now the result of

such action is easily seen. The poor insect is instantly electrocuted. Mr. Clark therefore had to find a way to detract the bug's attention from the cheese; so upon investigation he found that by slightly altering the phase relation of the cheese to the negative horn gap and by throwing pies at the shift engineer he could make the bug fly back and forth across the horn gap 596 times. Now the frequency of a June bug's wing is purely a matter of conjecture. It is rumored that the General Electric Company spent thousands of dollars upon research work along these lines and finally hit upon a method of ascertaining frequency. They found a man named Blanding, who rapidly became interested in the work and sent him to Marion. It is understood that Mr. Blanding's knowledge of the generation of insectivorous frequencies is wide and expensive and at some later date it is hoped to publish some results of his work along these lines.—Samuel Curtis in *World Wide Wireless*.

Electron Tube Transmitter—

(Continued from page 279)

their relative number of radio-frequency oscillations per cycle the vertical lines have been so spaced that each one represents a complete radio-frequency cycle.

It is not to be inferred from this diagram that the trains of voltage waves applied to the rectifier in a receiving circuit have an envelope precisely similar to the exponential envelope shown here for the wave-train transmitter from the spark set. Nor should the assumption be made that diaphragms of the receiving telephones, when acted upon by a strong voltage impulse lasting for one ten-thousandth of a second, are distorted a proportionately greater amount than when acted upon by a weak impulse lasting for a thousandth of a second. Undoubtedly, however, the voltage impacts acting upon the telephones are very much the more intense, tho lasting for a shorter time, with the wave train of higher peak value, and it is possible that this is the correct explanation of the louder signal furnished by the logarithmically modulated wave train with simple rectifying detector. If the same power be radiated at long wavelengths it is quite possible for the peak value of the logarithmically modulated wave train to be so reduced in magnitude that the average value of their square (which is the measure of the output voltage of the detector) is equal to or even less than similar values for the sinusoidally modulated waves. It is likely also that if the wavelengths of transmission be sufficiently increased, the same results in receiving the signals with a rectifying detector can be obtained with the tube transmitter as with a similar spark transmitter.

In summarizing the foregoing discussion the following essential points appear: (1) It has been found that an electron-tube transmitter operated *wholly from an alternating-current source* can be made to compare favorably in operating efficiency with a similar transmitter operated from a direct-current source; (2) it possesses the advantage of not requiring a high-voltage battery or generator; (3) the added advantage over a continuous-wave transmitter is that signals may be received over limited distance with non-oscillating detector.

A more complete description of the experiments made in developing this transmitter, and of the theory of its operation will be published at a later date as a Scientific Paper of the Bureau of Standards.—*Journal of the Washington Academy of Science.*

RADIO INDUCTANCE UNITS



All amateurs can now purchase honeycomb coils direct from the manufacturer. This means a substantial saving on each coil purchased, without any sacrifice in the results obtained.

Our price list covering various sizes will show you the advantage which this method of distribution gives you.

PRICE LIST

Turns	Price Unmounted
25	\$.50
35	.50
50	.60
75	.60
100	.65
150	.70
200	.75
250	.80
300	.85
400	.90
500	1.00
600	1.15
750	1.35
1000	1.60
1250	2.00
1500	2.50

Any of the above sizes will be mailed postpaid to all points in the U. S. upon receipt of remittance.

To avoid delay or possible loss remit only by Postal Money Order.

COTO-COIL CO.

87 Willard Avenue

Providence, Rhode Island

YOU HAVE A BEAUTIFUL FACE BUT YOUR NOSE?

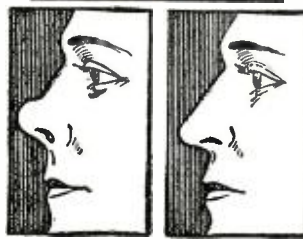

IN THIS DAY AND AGE attention to your appearance is an absolute necessity if you expect to make the most out of life. Not only should you wish to appear as attractive as possible, for your own self-satisfaction, which is alone well worth your efforts, but you will find the world in general judging you greatly, if not wholly, by your "looks," therefore it pays to "look your best" at

all times. Permit no one to see you looking otherwise: it will injure your welfare! Upon the impression you constantly make rests the failure or success of your life. Which is to be your ultimate destiny? My new *Nose-Shaper*, "TRADOS" (Model 24) corrects now ill-shaped noses without operation, quickly, safely and permanently. Is pleasant and does not interfere with one's daily occupation, being worn at night.

Write today for free booklet, which tells you how to correct ill-shaped noses without cost if not satisfactory
M. TRILETY, Face Specialist 1432 Ackerman Bldg., Binghamton, N. Y.



THE "ILLINOIS" VARIABLE CONDENSER

The Condenser with "Star Spring" Tension
MADE RIGHT—STAYS RIGHT
Hard Rolled Aluminum Plates

These condensers are made by a watch mechanic schooled in accurate workmanship. Personally we will need no introduction to Amateurs who have "listened in" for "time" and "weather" from 9. ZS.

Three Styles: No. 1. Panel; No. 2. Open Type as shown; No. 3. Fully Encased. Anti Profiteer. Less than pre-war prices. Fully assembled and tested.

Style No. 1	No. 2	No. 3	Money back if not satisfied. Just return condenser within 10 days by Insured P.P.
43 Plates, \$3.50	\$4.50	\$4.75	
23 Plates, 2.75	3.75	4.00	
13 Plates, 2.25	3.25	3.50	

Sent Prepaid on Receipt of Price.

Except: Pacific States, Alaska, Hawaii, Philippines and Canal Zone, add 10c. Canada add 25c. Foreign Orders other than Canada not solicited. NOTE: Above Prices Effective November 1st, 1920.

The "ILLINOIS" is rapidly adding to the number of its friends. The bouquets they fling only spur us to still more careful work, and more rigid inspection. It is a matter of pride that among the thousands of instruments sent out, not a single complaint has been received of bad condition. This may possibly be because every instrument is subjected to the scrutiny of the "old man's" eyeglass.

Now we will take you into our confidence, and tell you the reason for the above slight change in price. We know more about manufacturing costs than we did when we started. Then, there have been sharp advances in the cost of materials; in some cases nearly 100 per cent.

Again the difference in the price of the various sizes and styles were originally based almost entirely on the difference in material. Experience has shown that as the number of plates increases, the labor of assembling and adjusting increases in a much greater ratio. For this reason the slight advance we make in the new list is in the larger units; the smallest remaining unchanged.

Patent is pending on the "Star Spring" feature, which has been very valuable. The action of this spring produces an unvarying friction that holds the "rotor" in any position to which it may be set, and at the same time automatically centers the plates in relation to each other, and prevents any possibility of "endshake."

The plates are in proper relation by construction, and will remain so, obviating any necessity of readjustment. Once right, always right. Once mounted on your panel, there is one thing that you can depend upon to never give you trouble.

We again thank our friends for their letters of generous appreciation.

Kindly note: We issue no Catalog, and make no "trade discounts". We set our prices at the lowest limit, and leave the "middle man" out for the sole benefit of the "consumer".

G. F. Johnson, 625 Black Ave., Springfield, Ill.

The Professional Operator and The Amateur

By Claude Cathcart Levin.

THE gulf between the professional operator and the amateur is a wide one despite ideas held to the contrary. And as the "big game" tends more and more to become a profession and a life work with a future to it, the gulf widens instead of becoming smaller.

The reasons for the above are many and well founded and the fact that a distance separates the two is nothing to the discredit of either.

Most of the professional operators were originally amateurs and it is to be noted that for the first six months after entrance, they remain amateurs at heart. A short time after a man becomes a professional operator, he soon learns that the main and most important part of his duties are telegraphic instead of technical and that his worth will be judged by the radio superintendents by his ability to "handle the stuff." This is especially so if he is to operate on board a passenger liner where the passengers and ships business makes quite a respectable total during a voyage.

Unlike most of the other machinery aboard, the radio set must not be put out of commission unless it is absolutely necessary to make vital repairs. Down in the engine room they can and must be constantly overhauling the machinery even though it is in fairly good condition, and there are duplicates for most of the important units, even to the main engines when there are twin screws. Even if the vessel should be compelled to stop to effect repairs, it would be in no great danger but a radio set out of commission for even a short time causes great anxiety on the bridge. Consequently the natural inclination of the operator to keep his set in tip top repair is somewhat discouraged. This does not mean that the operator must not go over his apparatus very thoroughly at regular intervals, but it means that he must confine himself to only those repairs and changes that are absolutely necessary. It is because of this that the sets are made more and more "fool proof" all the time. The great service companies that have the contracts for the ships have large forces of repair and maintenance men and the apparatus is thoroughly gone over upon a ship's arriving and before sailing.

Another thing that tends to separate the professional and the amateur is the fact that the professional is in the game for a living and the amateur for pastime. Such incidents as that which occurred a short time ago when a New England amateur made public the traffic over the Submarine S5, hurt instead of help the profession. For the reading public, when reading the distorted press notices, imagine that the men who are paid to protect lives at sea are not as alert as the boys following their hobby. At least in this case, many laymen imagined and expressed it as their view that the professional lads had been caught asleep while the amateur saved the day.

Operators on passenger ships are constantly being told about young George so and so back home who receives messages from Germany, as well as from Africa and Japan. Oh George has not been bashful at all about his receiving exploits and the passenger forms a mental contrast not altogether in favor of the quiet young man at the key, when informed that the excellent set aboard has a probable range of five hundred miles in daylight.

The men on the long, lonesome oversea runs, however, fall back to the art itself and their old "ham" days. For the single operator on the cargo carrier has all the time in the world to get out his pet pri-

AS A FURTHER STEP IN REDUCING THE H C of Radio Apparatus

We offer the

"RVA" AUDION SOCKET

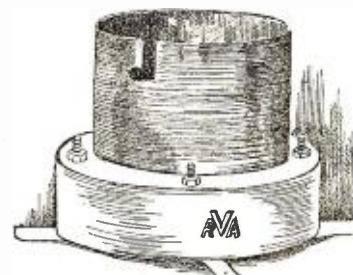

Price, Each 75 cents

Specifications: Base of pre-shrunk red fibre, assuring non-warping. Size 2 1/4" OD x 1 1/4" ID x 1/2" Thick. Shell is of 18 gauge polished brass tubing, machine cut and slotted. Contacts of 24 gauge phosphor bronze, 1 1/4" x 5/16" self cleaning (always), positive contacts. Contacts are connected thru four 3-48 round head brass machine screws, with two nuts on each. Sockets are all properly marked for connections and are individually tested to assure that every one is a perfect socket before being shipped. Immediate deliveries in any quantities; each.....75c Postage extra, 3c Each

And Remember

We sell ANY piece of ANY make of apparatus, parts, supplies, and raw materials on the **INSTALLMENT PLAN**. Send 20c for "RVA" BULLETIN, Loose-Leaf Binder and Bargain Sheet.

GREAT LAKES RADIO SUPPLIES CO., Inc.
Suite 6—First National Bank Bldg.
ELMHURST, ILL.

STANDARD RADIO EQUIPMENT

AGENTS FOR
MURDOCK BRANDS BURGESS GREBE BENWOOD SPEC. DE-FORST
FEDERAL TEL. AMERICAN RADIO AUDIO TRON. CHICAGO RADIO LAB. URELLIER TRECRO AND OTHERS
U. of I. SUPPLY STORE, Inc.
627-29-31 SOUTH WRIGHT STREET
CHAMPAIGN, ILLINOIS

SAVE MONEY TIME

A full line of wireless apparatus Sets manufactured to order. A trial will convince you.
KINGS HIGHWAY ELECTRIC CO.
1412 Kings Highway Brooklyn, N. Y.
Tel. 2472 Coney Island

THE NEW PARKIN CONDENSER

Balanced, non-shortcircuiting, easily mounted. Prices \$1.50 and \$2.00. Circular for stamp.
HEAVY GRAY CARDBOARD TUBING
3 1/2" and 4" diameters at 25c per foot.
BAKELITE PANELS
Postage extra on all orders.
A. K. LAING, RADIO SUPPLIES
Pelham Manor New York



LEARN WIRELESS

at the largest radio school in the Central States. Modern complete equipment. Experienced instructors. Dormitory in connection. Students may earn expenses if necessary. Write today for catalogue and full information.
CENTRAL RADIO SCHOOL
Independence, Mo

VACUUM-TUBES REPAIRED

Marconi—Moorhead—Audiotrons
Four Dollars Each, Postage Paid
Standard Grid Leaks, \$1.25; Bases, 60c; and Sockets, \$1.00.
THE DALTON LABORATORY
Dalton and Belvidere Sts., Boston, 17, Mass.

PACIFIC COAST AMATEURS

- Amrad Gaps.....\$18.75
- Magnavox 75.00
- Electron Relays..... 6.00
- Moorhead Vt's..... 7.00
- Transmitting Tubes..... 7.50
- Amplifying Transformers..... 5.00
- 2-Stage Amplifiers..... 40.00
- Audion Panels..... 15.00

We stock Radisco-Bunnell-De Forest-Murdoch apparatus—and others.

NORTHWEST RADIO SERVICE CO.
609 Fourth Avenue, Seattle, Wash.

Audion Control and Amplifier Panels

Neat, Efficient, Low Priced

Send stamp for circular or 5c for catalog
20th CENTURY RADIO CO., Greenville, Pa.

ROLLER-SMITH COMPANY

Manufacturers of

**Electrical Measuring Instruments
Meters and Circuit Breakers**

15 Barclay Street New York, N. Y.

vate stock and experiment. Lyons, Nauen, Annapolis and the rest furnish their quota of the world's affairs to the men on the ships plowing south of the line and in the lonely stretches of the ocean all over the globe. It is on these ships that the professional again becomes an amateur, or experimenter, as the name should be and dust gathers thick on the official receiver while special coils, bulbs, etc., drape themselves around the place and bounce merrily around when "she takes one over" and wallows in the trough.

In conclusion I wish to say that the thinking experimenter is a man who is thoroughly appreciated by the professional and the entrance of the latter into the game is a thing to be desired. For the good of the game now-a-days demands only the best and the QRM lads are due to go.

The Audion—Its Action and Some Applications

(Continued from page 282)

produces distortion of the speech currents is to that extent unfitted for use in tandem operation, because the distortion is cumulative in the successive repeaters; and mechanical amplifiers generally, and even the best of that type, produce distortion.

A large amount of unnecessary secretiveness or mystery was for some time thrown around the type of telephone repeater which made possible transcontinental telephony.

A well-known telephone engineer has recently stated that the audion amplifiers used by the American Telephone and Telegraph Company are practically distortionless, and are commercially used in tandem operation in regular installations, and were so used in the first transcontinental line, which would have been impossible without the use of the tandem arrangement. By actual trial over cable circuits approximately one thousand miles in length it has been found that as many as thirty of these audion amplifiers can be connected in tandem and produce excellent speech at the receiving end of the line. This engineer is authority for the statement that computation shows the attenuation of a cable circuit of this length to be so enormous that if all the power received on the earth from the sun could be applied in the form of telephone waves to one end of the line, without destruction of the apparatus, the energy received at the other end would be insufficient to produce audible speech without the use of amplifiers; whereas with thirty amplifiers used in tandem the relatively minute energy of ordinary telephone speech current at the transmitting end produced speech in the receiver at the opposite end which was both loud and clear, the amplification due to such a tandem arrangement of tubes being of the order of 10²⁰.

The audion which has been evolved to meet these requirements, most rigorous of all its numerous applications, differs in many details from the detector or the oscillating audion. The presence here of gas ionization sufficient to cause appreciable distortion cannot be tolerated, neither must the grid be permitted to be positive at any phase of the cycle of impress voltage. A hundred other minor requirements, small, yet difficult of realization, have been patiently achieved by our telephone engineers, who now state that "the amount by which it (the audion amplifier) fails to meet all the requirements for a perfect repeater is so small as to be negligible except under the most rigorous conditions."

The illustration (Fig. 19) conveys a more (Continued on page 335)

NEW THIS MONTH



STANDARD WILCOX PARTS

Type 121 Rheostat

Suitable for table or back of panel mounting. Has turned aluminum case, convenient binding posts and 6 ohm resistance unit with all off and all on positions. Long bearing and special designed blade insure smooth running and positive contact. Only occupies space 2" in diam. on your panel. No. 121A with Type 116 Dial \$2.50. No. 121B with Knob and Pointer \$1.75.



Type 101 Panel Switch

A beautiful and efficient rotary switch for general use. Furnished in two sizes. 1" radius brass finish 40c. Nickel finish 50c. 1 1/2" radius brass finish 50c. Nickel finish 60c.

Type 102 Panel Switch

A compound switch consisting of two electrically independent switches mounted with concentric knobs. 1 1/2" radius brass finish \$1.10. Nickel finish \$1.25.

Type 103 Panel Switch

A rotary panel switch which is double pole and double throw. Will change variable condenser from series to parallel, etc. 1 1/2" radius brass finish 75c. Nickel finish 85c.

Type 104 Panel Switch

A complete unit for back of panel mounting. The latest and best in rotary panel switches. Better looking, more efficient and easier to mount. Complete with Type 116 Dial and 6 contacts \$2.25. Complete with Type 116 Dial and 11 contacts \$2.50.

Switch Contacts

Threaded shank contacts with heads 3/16"x1/4"—14 other styles in our catalog. No. 112E Brass 2 1/2c. No. 112F Nickel 4c.

Type 116 Indicating Dials

Of polished hard rubber accurately engraved, filled with brilliant white, furnished complete with knob and bushing to fit 3/16" shaft. 90° scale 0-50 or 180° scale 0-100. 2" diameter \$1.25. 3" diameter \$1.50.

Type 5A Variometer Parts

Set No. 1 contains carefully turned wooden parts including winding form. Price \$2.50. Set No. 2 contains all parts including 3" Type 116 Indicating Dial. Price \$5.00.

Type 14A Rotary Gap

The best gap on the market. Belt driven, well quenched, clear tone and high efficiency. Price \$10.00.

Order from this ad or send five cents for catalog. All prices Postpaid.

We are prepared to make apparatus to order or do any kind of experimental work.

The Wilcox Laboratories, Inc.

Manufacturers

Lansing, Dept. G. Mich.

Type 14B Rotary Disk

The same style rotor as used on our famous belt driven gap, only with bakelite center and brass bushing to fit your motor shaft. Size is 4 1/2" diam. and 9/16" thick. This rotor being light and perfectly balanced will give excellent results on any small high speed motor. State size of shaft when ordering. No. 14B Rotary Disk \$8.00.



Variocoupler Rotor

A carefully turned hardwood form for the secondary coils of variocouplers, etc. Size is 3 1/2" in diameter and 2" wide. No. 101 Rotor \$1.00.



Type 5A Variometer

Made from Wilcox Variometer parts, completely assembled as illustrated, may easily be mounted on panel if you wish. Wave length range in average circuit with coils in series about 175-450 meters. No. 5A Variometer \$8.

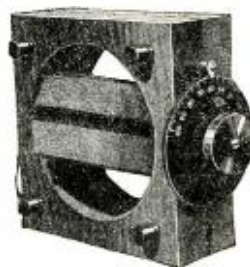

ALL PRICES POSTPAID

RELIABLE DEALERS WANTED

NEW MOTORS

FACTORY GUARANTEED ALL SIZES PROMPT DELIVERY

 <p>Charging Generators Suitable for all lighting, Battery Charging and Power Requirements.</p> <p>8 v., 10 amp. \$19.50 15 v., 10 amp. \$26.50 40 v., 6 amp. \$31.50 110 v., 2 1/2 amp. \$31.50 110 v., 5 amp. \$52.50 40 v., 12 amp. \$52.50 110 v., 9 1/2 amp. \$67.50 40 v., 25 amp. \$67.50 110 v., 18 amp. \$116.50 40 v., 50 amp. \$116.50 110 v., 26 amp. \$156.50 110 v., 50 amp. \$238.50 Moving Picture Arc Generator 60 c., 35 a. \$116.50</p>	<p>Polyphase Motors 2 and 3 phase. A. C., 220 v. 60 c., 1750 R.P.M. Complete with base and pulley</p> <p>1/2 H.P. \$46.50 1 H.P. \$66.50 2 H.P. \$86.50 3 H.P. \$98.50 5 H.P. \$116.50 1 H.P. Special Grinding and Buffing Motor \$106.50</p>	<p>Direct Current Motors. 110 or 220 volts, D. C., shunt wound, 1750 R. P. M. With base pulley and starting box.</p> <p>1/4 H. P. Washing Machine Motor \$28.50 1/4 H. P., 32 v. Washing Machine Motor \$28.50 1/2 H. P. \$58.50 1 H. P. \$82.50 2 H. P. \$124.50 3 H. P. \$142.50 5 H. P. \$218.50</p>	<p>Single Phase Motors 110-220 volts, A. C., 60 cycle, 1750 R. P. M. with pulley</p> <p>1/4 H. P., 220 v., induction Washing Machine Motor \$28.50 1/4 H. P., 110 v., grinding balling motor \$28.50 1/2 H. P., induction, full load start \$46.50 1/2 H. P., regulation induction For compressor service \$54.50 1 H. P. regulation induction, Special Garage Motor \$74.50 2 H. P. regulation induction with sliding base \$126.50 3 H. P. regulation induction with sliding base \$146.50 5 H. P. regulation induction with sliding base \$188.50</p>
---	--	---	---

WRITE FOR CATALOG. BARGAINS IN MOTORS AND GENERATORS

1/4 SPECIAL
110 volts
A.C., 60 c.
S. P., 1750 R.P.M.
Complete, cord, plug and pulley

WASHING MACHINE MOTORS
Suitable for operating Small Cleaners, Presses, Coffee Grinders, Bottle Washers, Etc.

\$26.50 Each

MANUFACTURERS' DISTRIBUTOR

SHIPPING TERMS: 25% deposit required on all orders. Balance C. O. D. by Express. Slight draft with Bill of Lading attached by freight.

CHAS. H. JOHNSTON, Box 16, West End, Pittsburgh, Pa.

RADIOTRONS

Vacuum Tubes

for

Radio Detection and Amplification

THE RADIO CORPORATION OF AMERICA is pleased to announce the development of a complete new line of VACUUM TUBES for general amateur or experimental use. The facilities and resources of the great Research Laboratories of the General Electric Company have been brought to bear upon the production of new types of Electron Tubes, two of which are now ready for sale.

RADIOTRON U. V. 200 is a gas content detector and amplifier of unusual capabilities and of novel manufacture. It has been designed to meet an insistent demand for a detector and audio frequency amplifier tube which operates from a single standard 22½ volt plate battery (18 to 22½ volts).

LIST PRICE
\$5.00

Radiotron U. V. 200 is particularly adapted to amateur regenerative circuits in which it provides more uniform action than any vacuum tube yet devised.

NOTE—A special "A" or filament battery potentiometer for close adjustment of the plate voltage of U. V. 200, will be placed upon the market shortly. Radiotron U. V. 200 requires a standard grid condenser and grid leak for best detector action.

RADIOTRON U. V. 201 is an unexcelled AMPLIFIER of the PLIOTRON type, designed for detection and for radio and audio frequency amplification. Normal plate voltage, 40 (two standard plate batteries). Plate voltages up to 100 may be used with increased amplification. Amplification constant 6.5 to 8 at 40 volts, 8 to 10 at 100 volts. Impedance, 15,000 to 25,000 ohms at 40 volts on the plate, 10,000 to 15,000 ohms at 100 volts on the plate.

LIST PRICE
\$6.50

All tubes are manufactured to rigid specifications and fitted with standard four-prong bases. Filaments operate off 6-volt battery with rheostat.

Deliveries to dealers begin December 1st. Orders for small quantities can be filled from November 15th on.

LIST PRICES

Radiotron U. V. 200	\$5.00
Radiotron U. V. 201	6.50
Standard Vacuum Tube Socket	1.50
Standard Grid Leak-Mounted, 100,000 ohms to 6 megohms	1.25
Grid Leak Unit75
Grid Leak Mounting50
Audio Frequency Transformer	7.50

A complete line of vacuum tube ACCESSORIES are now in manufacture and will shortly be available

DEALERS AND JOBBERS

We have an especially attractive proposition for you. Write us at once.

The Radio Corporation's tubes are covered by patents dated November 7th, 1905, January 15th, 1907, and February 18th, 1908, as well as by other patents issued and pending. Tubes licensed for amateur or experimental use only. Any other use will constitute an infringement.

Address all orders or enquiries to

SALES DIVISION

COMMERCIAL DEPARTMENT, Radio Corporation of America

233 Broadway, New York City

(Continued from page 333)

vivid idea than any description of the thoro completeness with which the American Telegraph and Telephone engineers have applied the audion repeater to the commercial long-distance telephone service. It illustrates a typical group of repeater racks, each rack carrying two complete repeaters. This view was taken at one of the main repeater stations on the Boston-Washington underground cable line, located at Princeton, N. J.

The third and final part of this article will appear in our December issue.

Club Gossip

(Continued from page 291)

Word has been received from the American Radio Relay League headquarters in Hartford that the county association and all its sections have been officially affiliated with the national organization and charters will be forwarded at once.

For the first time in the history of amateur radio, the whole of the United States has been visited by officers of the league. Hiram Percy Maxim, president, attended a convention of the west coast amateurs at the San Francisco Radio Club in August. J. O. Smith, traffic manager, has been all through the middle west and southern states and Kenneth B. Warner, secretary, is now attending a convention of the central states amateurs in Chicago. All of the national officers will probably attend a convention of the New England amateurs at Worcester the last of this month. Essex county will be well represented at this convention.

At a meeting of the Lynn section recently held a unanimous vote of thanks and support was given F. Clifford Estey, county president, in approval of his activity and results obtained and he was instructed to continue his effort to build the whole of Essex county into

HOOSIER RADIO LEAGUE.

The Hoosier Radio League held its first meeting at the Y. M. C. A. recently. Seventeen Howard county radio amateurs were present. The following officers were elected: Kenneth Schneiderman, president; George Machin, vice-president; Ervin Middleton, treasurer, and Walter Lanterman, secretary.

Mr. Machin gave a short talk on the purpose of the organization, in which he outlined the activities of the league for the coming year. He stated that a careful study of the Government laws and regulations relative to amateur radio communication would be made, and all members of the Club would be expected to obey them. New members will receive instructions on the operation of instruments and also on the code. The league also plans to erect a station which will be on exhibition at different times to acquaint the public with the work that is being done by the amateurs.

A research committee was appointed their business being to find the answer to any question concerning radio that may be brought before the Club.

Anyone desiring to join will be considered as charter member by enrolling on or before that time. Write to Secretary Lanterman, Hoosier, R. L., Y. M. C. A., Kokomo, Ind.

ATLANTA, GA. RADIO CLUB.

Announcement has been made of a meeting every Friday night of the Atlanta Radio Club at the Georgia Tech Radio Station for a class in radio work.

All members of the Atlanta Radio Club who cannot receive as fast as the words a minute are requested to become members of the class, as well as all young men of Atlanta interested in wireless telegraphy. The radio class will be organized for the summer session Friday night. The Georgia Tech Radio Station is regarded as one of the best equipped wireless stations in the South.

ROCHESTER RADIO CLUB.

The Radio Club, composed of amateur wireless operators in Rochester, reopened activities at a meeting at the Central Y. M. C. A. recently. The Club has been adjourned during the summer on account of unfavorable operating conditions.

The members have many plans for the winter, including the building of a radiophone and the establishment of Rochester as a regular station on some of the amateur relay routes. This will be made possible by the fact that several members have sets of adequate power for efficient relay stations. Visitors are cordially welcomed at any of the Club meetings.

(Continued on page 236)

Knock 'Em Dead This Winter **Get A Benwood Disc.**
Here is a real disc.

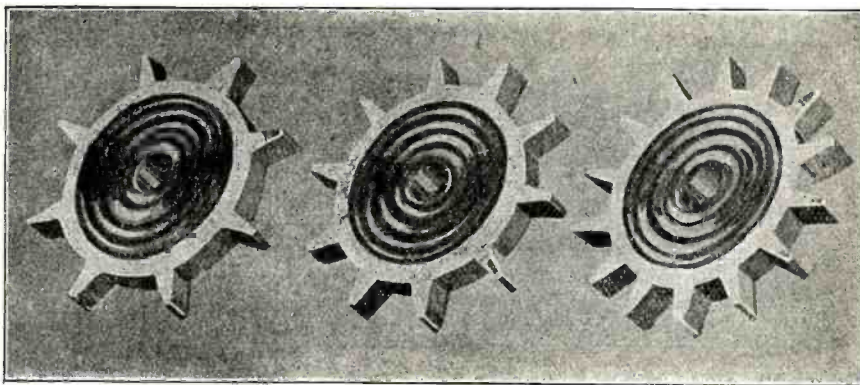

Give the old spark a chance. It will do the rest. Make your call famous thruout the country. Gives a clear musical note. The disc is a solid aluminum casting, true to the hundredth part of an inch.

Made with 4, 8, 10 and 14 points. Drilled for any size motor shaft. Has WIDE sparking points that are tapered, thus giving the quick break that is so much desired by those who know.

Designed for 1 K. W. installations

Order from your dealer. He has them in stock. If not we can ship direct and make IMMEDIATE shipment.

Specify size of motor shaft when ordering.

9 L C

THE BENWOOD CO., Inc.
Cor. 13th and Olive Sts., St. Louis, Mo.

9 K U

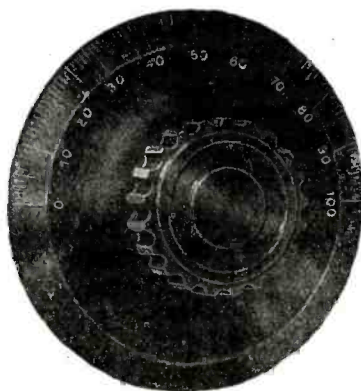

The Corwin DIALS

are now being used exclusively by the Radio Distributing Company and are fast becoming the standard for all manufacturers whose radio apparatus is of a superior nature and Radio Men who desire the best.

ACCURATE INDICATION

When you want an indicating dial for superior performance of accurate indication, buy the Corwin Dials. The finely black polished composition, with radial lines and figures engraved in brilliant white gives an indication that can not be equalled by any other.

Made in two sizes, three and three and seven-eighths inches in diameter. This larger dial fills the popular demand for an indicator to fit the standard one-quarter inch shaft.

We are distributors of the better class of radio apparatus and offer a superior service on products manufactured by A. R. Co., Acme, Radisco, Murdock, Radio Craft, Clapp-Eastham, Moorehead, etc.

3 in. dial only, 75c., with knob, \$1.30; 3 7/8 in. dial only, \$1. with knob \$1.70. Sent postpaid anywhere.

Ten cents brings our latest catalog to you, describing the above dial and all standard radio apparatus.

A. H. CORWIN & CO.

Department B2

4 West Park Street

NEWARK, N. J.

R K L A U S D I O

Supersensitive Apparatus

for every requirement. Let us design and equip your Radio Laboratory.

WATCH this space next month for details of our 6-volt 60 ampere storage Battery and dealers who carry them.

Amateurs, Dealers, Radio Clubs, Schools, the most advanced designs in modern Wireless Apparatus are included in the Klaus line.

Let Us Serve You

Distributors for Grebe, De Forest, Moorhead, Amrad, Murdock, Anco, Acme, Radisco, Tresco, C-E, etc.

KLAUS RADIO CO.

EUREKA, ILL. — 238 So. Jefferson St., PEORIA, ILL.

Just Two More Items of Our Wonderfully Complete Stocks

**ARNOLD
LOOSE
COUPLER**
\$24.00

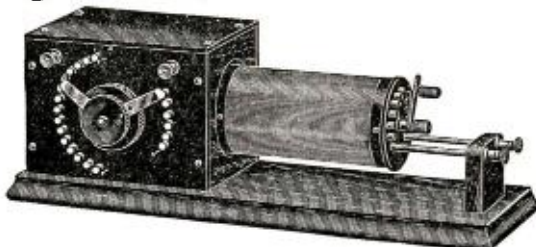

Both instruments shown here are examples of the high quality goods which we carry. Our large volume of business combined with econom-

ical methods enables us to offer you "everything in radio" at unusually favorable prices. Mail orders filled promptly and accurately.



Trumbull Switch
600 Volts \$4.00

Present stock of catalogues exhausted—new issue ready Dec. 1st. If those who sent 10c for catalogue will notify us, their money will be refunded or applied to new catalogue, as desired.

AMERICAN ELECTRO TECHNICAL APPLIANCE CO.
Dept. E, 235 Fulton Street New York

ATTENTION!

British Detector developed during the war is now being manufactured in this country. Tube form.

Requires No Batteries
\$3.50 Postpaid

Send for descriptive circular

STRATFORD AGENCY
576 Ocean Parkway, Brooklyn, N. Y.

NEW ORLEANS RADIO

**APPARATUS
and SUPPLIES**

ROSE RADIO SUPPLY
604 Gravier St., New Orleans, La.
Send 10c for Latest Catalog

(Continued from page 335)

HAMPTON ROADS RADIO ASSN.

T. C. White, Jr., of Norfolk, Va., was elected president of the Hampton Roads Radio Association, at a meeting held in the Norfolk Radio School recently. Other officers were elected as follows:

Vice-president, L. C. Herndon, Portsmouth; secretary-treasurer, R. L. Hopkins, Norfolk; chief of construction, H. L. Busk, Norfolk, and chief operator, S. A. Rosenthal, Norfolk. They are named for semi-annual terms.

Mr. Van Norstrand, U. S. radio inspector, who was organizer of the association, which promises to become one of the leading radio bodies in the country, has begun a series of lectures for beginners and advanced amateurs and all members are urged to attend the meetings to hear these addresses. Also, all persons interested in radio work are invited to join the association.

At the meeting, aside from discussion of important matters and transaction of routine business, steps were taken for the prevention of unnecessary interference with radio messages, caused by local work as well as by ships. The schedule to be followed for communications was arranged as follows:

7 to 10 p. m.—local work only.
10 p. m. to 6 a. m.—long distance work only (from 50 to 4,000 miles or more).

6 a. m. to 7 p. m.—free ether for all communications and testings.

In abiding by this schedule, it is said, the members of the association will greatly help the relaying and handling of wireless messages. The next meeting will be held in the old class room of the Norfolk Radio School, Main and Atlantic Sts., Norfolk, Va.

ALBANY RADIO CLUB.

The Albany Radio Club at a recent meeting in the Y. M. C. A. initiated several new members. After the regular business the Club went to the electro chemical laboratory of the Shatlon Manufacturing Company where the construction of rheostats was demonstrated by Harry Mulligan and the winding of field coils explained by Mr. Arnold of the General Electric Company.

PORT JERVIS RADIO CLUB.

At a meeting held at the residence of T. H. Willers in Matamoras recently, a radio club was formed by the radio amateurs of Port Jervis and vicinity. The Club will be known as The Radio Club of Port Jervis. Meetings will be held on Tuesday night of each week at the residence of Mr. Willers. Code practice and radio topics will be the main feature of the meetings. Some of the members have already receiving sets, which were constructed by the owners, and those that have not sets will build or are building them. The present membership consists of T. H. Willers, William Slater, R. Halsted, R. Whittington, R. Wohlscheidt.

TRIANGLE RADIO CLUB.

The Triangle Radio Club is a new club formed by amateur radio operators in Rochester, N. Y. The officers are: President, Hugh Stevenson; vice-president, Victor Martin; secretary, Thomas J. Whalen; treasurer, George Hall; publicity agent, J. K. Marcus. Meetings are held in the homes of members. Much interest is being displayed in the new vacuum tube which is to replace the crystal detector. The tube is said to enable the operator to get messages from Eiffel Tower, Paris; Naun, Germany, and other places in Europe.

An amateur of Rochester may become a member of the new club by passing a test. Dues are 25 cents a month. Amateurs desiring to join should write to Hugh Stevenson, president, at 176 Benton St.

RADIO CLUB OF WESTFIELD, N. J.

These officers have been elected by the newly formed radio club of Westfield, N. J.: President, Christopher Hobson; vice-president, Edward Hubert; secretary, Donald Vervoort, and treasurer, Leslie Payne.

The club is composed of young men and youths of the town who are interested in wireless telegraphy and wireless telephony. All radio amateurs not yet affiliated with the club are invited to attend the meetings which are usually held weekly in the Prospect Street School building. Permanent headquarters elsewhere are expected to be obtained before the cold weather season comes on and some very interesting meetings will be held this fall and winter.

RADIO CLUB OF BURLINGTON, IOWA.

The boys of the Radio Club of Burlington have received a letter of commendation from J. W. Sackrider, past admiral of the Mississippi Valley Power Boat association congratulating them upon the work done in connection with the regatta.

Admiral Sackrider wrote: "I am sending this letter in appreciation of the many favors shown the Mississippi Valley Power Boat association at our recent meet in your city, and I want to assure you that it is gratifying to have had the pleasure of letting you time "Miss Toronto," at which time she broke the world's record, and I hope that at some future meet, we will be able to have the pleasure of using your boys again."

READ THE CLASSIFIED ADVERTISEMENTS ON PAGES 340-342 YOU'LL FIND MANY GOOD THINGS THERE.

WASHINGTON, PA. RADIO CLUB.

A meeting of the wireless club of the Washington High school was called recently and the following officers were elected to serve this winter: President, Thomas McNary; vice-president, Sam Workman; secretary and treasurer, Charles McNary.

This club has the finest wireless set in town set up in the school building and they expect to get in some good work with it this winter. There are approximately thirty-five members in the organization already, and more are expected to join. Some new equipment is to be added to the set and a license will be taken out by some member of the Club so that they can operate as a registered send and receiving station.

SAN FRANCISCO RADIO CLUB.

A convention of radio manufacturers, the initial conference of its kind on this coast, will be held in San Francisco in the latter part of October, it was announced recently by the San Francisco Radio Club.

The three-days' session will open with an address over a radio telephone to the convention hall.

The instrument will be installed by the De Forrest Radio Telephone and Telegraph Company, under the supervision of R. M. Klein. By radio, too, it is planned, dance music will be furnished for entertainment.

The Man Who Stands By

(Continued from page 289)

The commander left the radio room reiterating that the vessel was sinking and that all hands make for the lifeboats.

Goodwin contemplated the radio instruments. Here was a situation he thought when they would be of no use. He had installed a four stage amplifier for receiving purposes, thus it was possible to receive stations half way around the world when he so desired.

In this particular case Goodwin as a radio man was not particularly useful. The officers on the ship were too busy to realize the vessel was sinking. To locate them in the tumult raging below was impossible. Goodwin's eyes rested upon the loud sneaking telephone which he sometimes used when certain passengers requested to hear music from an obliging orchestra in San Francisco. With this horn, for it was little more, a phone being attached to the mouthpiece, the signals could be heard over a large part of the steamer.

Goodwin detached the phone and stepped from the room, the mouthpiece resting securely before his mouth. Then in his loudest voice, which sounded like a dull roar, yet audible about the ship, he cried out the news that the vessel was not sinking and that the captain had become a raving maniac which accounted for the false alarm.

After a few moments passengers heard him. They stopt their mad rush and listened. Officers heard and repeated the information. Gradually everyone knew that a dreadful hoax had been played on them. The engineers returned to their duty, the fires were replenished and soon the vessel was again moving.

Then after all was again quiet the result was ascertained. No one had been killed. Many were injured, however, and some seriously so that the ship's doctor became a busy man.

The captain could not be found. It was supposed he had jumped overboard in his maniacal panic.

Sundown found the ship was in complete order and the night passed quickly by. Day broke and the ocean awakened as an obedient child not yet ready for mischief.

That day was a busy one for Goodwin. Grateful thanks were coming from every direction. All now knew who had saved human life by a well controlled and quick witted mind.

Then the next day of the voyage dawned gray and sultry. Clouds hid the sun and a storm threatened. No one seemed to care, not while the radio man rested comfortably before his apparatus—always ready to stand by.

We Take Pleasure

in announcing the opening of a branch store of the ATLANTIC RADIO CO., at 15 Temple Street, Portland, Me., facilitating quick deliveries to Northern New England amateurs. A complete stock of Radio Equipment is available at all times.

This Month we call your attention to the two new vacuum tube units illustrated. Both instruments are designed to incorporate the standard Vacuum Tube, Engraved Bakelite Panel in Oak Base.

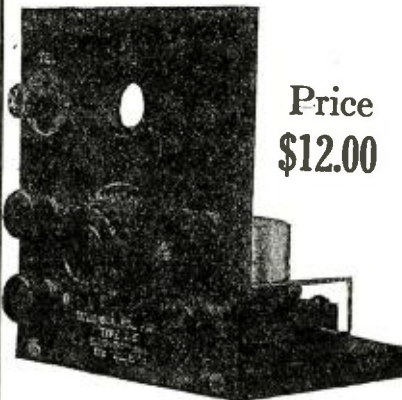

Price \$12.00



Price \$18.00

Read This Letter

Rochester, N. Y. June 30, 1920.

Atlantic Radio Co.

Gentlemen:—I wish to thank you for your very prompt service which you gave me on my last order and for your ability to deliver at once just what was wanted. Such service as I received is so unusual that I cannot refrain from thanking you. The goods you sent were all perfect and the best of the kind I have yet seen.

Very truly yours,
(Name on request.)

"Bulletin 14" 108 pages—over 100 illustrations—sent upon receipt of ten cents. A Rebate Certificate good for 10 cents on first dollar order is inclosed.

ATLANTIC RADIO CO.

Incorporated

MAIN OFFICE:
88 Broad St., Boston 9, Mass.
PORTLAND BRANCH:
15 Temple St., Portland, Maine

**A
A
C
E
E**

"IN THE GOOD OLD SUMMERTIME"

You did not get that C-W set fixed up. Get busy now so you will be in for the coming season. We have parts or finished instruments. Only the best get our list before buying.

DEALERS, if you are going to be ready for the Holiday rush, let's have your orders. We are going to publish our dealers' list, get your name in. Our apparatus is licensed under Armstrong Patent No. 1,113,149.

Remember—"You may pay more but you can't buy better."

THE PRECISION EQUIPMENT CO.

Dept. A. 2437 Gilbert Avenue Cincinnati, Ohio

SOMETHING NEW!

THE "REAUDIFIER"

REPLACES THE TWO STEP V.T. AMPLIFIER

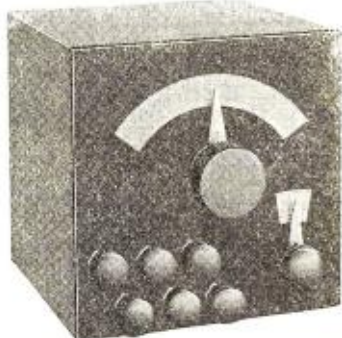

SUITABLE FOR EITHER DAMPED OR UNDAMPED RECEPTION

THE "REAUDIFIER" IS ESSENTIAL IN THE DEPENDABLE STATION

The REAUDIFIER is undoubtedly the best and cheapest means for securing amplification. The REAUDIFIER contains no bulbs, microphones or other commonly known means of amplifying. The REAUDIFIER is distinctively new! It is the last word in amplifiers. Simply connect it to a single VT detector panel, connect your phones or loud speaker to the REAUDIFIER and you have the equal of a detector and a common two step VT amplifier. No critical adjustments. No bulbs to burn out. No batteries to buy. Only one knob to adjust, and the first cost is much cheaper than the VT amplifier and this cost is the only cost.

EVERY STATION CAN NOW HAVE A RELIABLE AMPLIFIER

If you now have a VT you can have an amplifier at small cost. If you have a VT with VT amplifiers you can cut your operating expenses by installing a REAUDIFIER.

CONSTRUCTION AND FINISH THE BEST

Not only is the REAUDIFIER a big utility but it is also a handsome addition to any operating table. You'll be proud of your REAUDIFIER! The working parts are entirely enclosed in a cabinet cube 4 1/2 inches square. The woodwork is well seasoned hard-wood, beautifully finished. The operating panel is made of the best grade Bakelite-Dilecto accurately cut and highly polished. All parts are heavily nickled and the entire instrument is a thing of beauty. Each REAUDIFIER is guaranteed to give satisfaction for five years.

EQUIP YOUR STATION WITH A REAUDIFIER AT ONCE

Get in on the long distance relay work this winter. Get the signals loud! The REAUDIFIER will do it. It has proven "best by test." Order yours today.

Send Money Order or Personal Check.

PRICE OF GENUINE "REAUDIFIER" Complete \$35 shipped prepaid in United States.

THE C AND S RADIO-ELECTRIC CO.

"Superlative Radio and Electrical Engineering Productions"

2916 NORTH 16th STREET, OMAHA, NEBR.

SPECIAL OFFER

As a special offer the REAUDIFIER will be sold for \$33 until December 10th. Buy now and save the difference.

DEALERS— Write for Agency.

An Efficient "Two-Way" Listening Circuit

By DAVID L. MOORE.

In dealing with the amateur radio station of the present day, one can be pretty safe in assuming two things: first, that the amateur "opr" is not satisfied with simply "working," or copying his brother amateurs, but likes to keep in touch with the "commercials" also, on their six hundred meter wave; secondly, that he will require a variable condenser in the primary of his receiving circuit for amateur signals, but not for those of the commercial stations.

Many manufacturers of amateur receiving sets have apparently overlooked these features, with the result that the average wireless "fan" often finds himself with an empty pocketbook, and a set that will not copy the signals in the six hundred meter neighborhood with efficiency.

The diagram herewith indicates a circuit which will not only give high efficiency

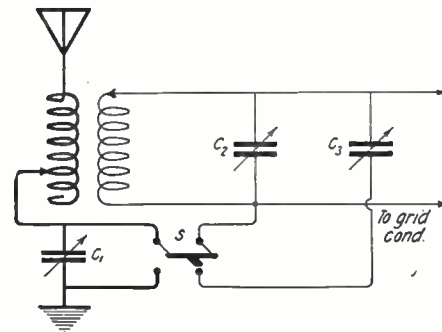

"Two-Way" Switch Which Has Proved Effective to Mr. Moore.

from 100 to 800 meters, but enables instantaneous changing from a perfectly tuned-in 200 meter station to one of 600 meters by means of one single-throw switch.

To operate these circuits, first tune, by experiment or wave meter, the primary of the receiving transformer so that the primary circuit will respond to 600 meter signals, with switch S closed, "shunting" the primary condenser C1. It will be observed that closing the switch also places condenser C3 in the secondary circuit; condenser C2 always remaining therein. Now by tuning the two secondary condensers C2 and C3 so that their combined capacity together with the inductance of the secondary of the "tuner" will comprise a circuit responding to a six hundred meter wave, the set will be in perfect tune for commercial stations.

Now for 200 meter wave lengths, open switch S, tune primary to that wave length with condenser C1, and secondary with C2, condenser C3 now being out of the circuit.

A few experiments will soon determine the proper capacity of all three condensers for any two particular wave length, after which they need not be touched, for "listening-in" work.

It should be observed that the lower secondary lead in the diagram should be connected with the grid condenser circuit, for if the other lead is used the capacitive effects of condenser C3 are detrimental to short wave work.

This circuit has proved invaluable to the writer, who, being an ex-commercial operator, likes to listen to the "traffic" as well as his amateur friends. It is hoped that others will enjoy its convenience.

Sparks from the Radio World

Mr. Harold Hymans, formerly Radio Engineer in charge of the Radio Dept. of the Smerry Gyroscope Co., has resigned and is now connected with the Radio Service & Mfg. Co., Lynbrook, L. I., as General Manager.

Insure your copy reaching you each month. Subscribe to Radio News—\$2.00 a year. Experimenter Pub. Co., 233 Fulton St., N. Y. C.

Baldwin Mica Diaphragm Amplifying Telephones

In an effort to cut down the high cost of radio and to gain the confidence and good will of all progressive amateurs, we are offering a reduction on the most sensitive wireless receivers on the market, the Baldwin Mica Diaphragm Telephones.

Improved Type "E." The high natural period of the small mica diaphragm, together with other developments, make the Improved Type "E" especially receptive to high pitched notes.

This model is lighter in weight than the original type "C" and is less liable to become damaged by careless handling.

Improved Type "E" Our price \$19

(List price \$20) Standard Navy Type "C"

(List price \$16.50) Our price \$15.50

Signal: that cannot be heard with the best types of wireless receivers of conventional construction become easily readable with the above mica diaphragm types.

The Kehler Radio Laboratories 901 W. First St., Dept. R., Abilene, Kans.

WIRELESS CABINETS

Blank Wireless Cabinets are a new addition to some Radio Manufacturers' catalogs, but we have been building and selling blank Cabinets for months.

We were the originators of the Drawer Bottom Blank Cabinet, which was, and still is, the best constructed and highly polished Cabinet on the market today.

When we commenced building these Cabinets we set a new standard for quality, workmanship and finish, which has placed our Cabinets in a field above competition, and they will not and cannot be duplicated at our prices.

When you buy one of our Cabinets you only pay for Quality—not elaborate advertising. Do not buy a blank Cabinet until you have read our bulletin No. 101. Write for it—it's free.



Penn. Radio Apparatus Co. Dept. RN. Reading Pa.

SPECIAL BARGAIN SALE

MOTORS
MOTORS
MOTORS
MOTORS
MOTORS

1/16
H.P.

\$7.50

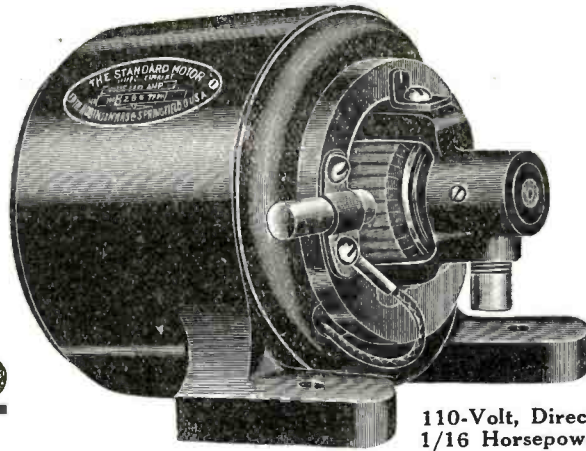

110-Volt, Direct Current,
1/16 Horsepower Motor

**SPECIALLY
SUITABLE
FOR
ROTARY
SPARK-GAPS
BIG BARGAIN**

1/16 H.P. MOTORS

SPECIFICATION

Enclosed type, practically dust proof. Shunt wound. Motor reversible. Constant speed. Carbon brushes. Oil cups—self-regulating. Extra fine commutator, made up of 32 segments. Speed 1,800 R.P.M. Bi-polar type machine.

No pulley. Size over all 4 1/4 x 5 x 6 1/2 in. Black Japan finished casing. Shipping weight 15 lbs.

Our Price

\$7.50

As long as they last

Built for the Government by
Robbins & Myers

Slightly used, but we guarantee them to work perfectly. These splendid, powerful little motors sell, elsewhere, for from \$15 to \$20. Don't hesitate to take advantage of this unheard-of low price, at once. Send your order today.

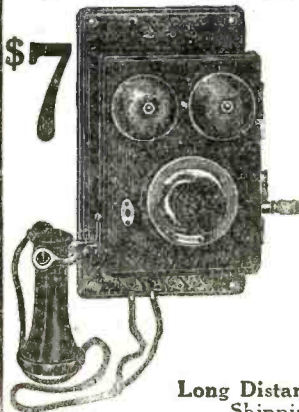

For Homes, Offices, Factories, Farms

Complete Wall Set Magneto Telephone

Western Electric Type

This is a complete commercial telephone station. They were bought from telephone exchanges who put in Central battery types. Slightly used but guaranteed to be in A1 working order.

Will work perfectly at all distances up to 20 miles.

Long Distance Telephone Set—One station
Shipping weight, 15 lbs. **\$7.00**

Two stations
Shipping weight, 25 lbs. **\$13.00**

WIND YOUR OWN HIGH- OHMAGE RECEIVERS



This wire, which is so fine that over 45,000 feet go in one pound, is used for all high grade Wire-less Receivers. We have only the following few spools left over. Order at once. First come, first served.

No. 44 B. & S.
Enameled Wire

Weight—Hundredths of lbs.	Weight—Hundredths of lbs.														
	40	36	14	39	38	28	149	34	29	30	36	16	46	22	43
Amt.	\$9.20	\$8.28	\$3.22	\$8.97	\$8.74	\$6.44	\$11.27	\$7.82	\$6.67	\$6.90	\$8.88	\$3.88	\$10.58	\$5.06	\$9.89

Don't send any Money! Simply select the spool wanted and we will send it, or the next in size, C. O. D.

Remember as always in our sales: *First come, first served.*

Add Postage or we will Send by Express Collect

IMMEDIATE SHIPMENTS!

The Electro Importing Co., 231 Fulton Street, New York

OPPORTUNITY AD-LETS

Follow these advertisements every month. Reliable advertisers from all over the country offer you their most attractive specialties in these columns.

Classified advertising rate four cents a word for each insertion. Ten per cent discount for 6 issues, 20 per cent discount for 12 issues. Name and address must be included at the above rate. Cash should accompany all classified advertisements unless placed by an accredited advertising agency.

Objectionable or misleading advertisements not accepted. Advertisements for the January issue must reach us not later than December 10.

THE CIRCULATION OF RADIO NEWS IS OVER 40,000

EXPERIMENTER PUBLISHING CO., INC., 233 and 236 Fulton Street, New York, N. Y.

Agents Wanted.

Ten Cents Will Bring You a sample of the inkless pen. When dipped in water writes a black permanent ink. Lasts indefinitely. Your spare time is worth money. Our proposition accompanies pen. Coldwater Pen Co., 220 E. Sixth St., Cincinnati, Ohio.

Man to Distribute Samples, circulars, for "Foot Ointment" mail or hand; splendid opportunity. Write us today. Address The Elder Co., 290 Parkdale, Buffalo, New York.

Aeronautics.

Interested in Aeronautics? Send for our wonderful new shoot the shoot aeroplane glider. Guaranteed to fly. Mailed postpaid \$1.00. Illustrated leaflet of Broadfield toy aeroplane sent free. Do they fly? Oh-Boy, Address Broadfield Flyer, Box 24, Hempstead, N. Y.

Build the Latest Aeroplane Models. Exact duplicates of those in use today. Accurate models that fly are built from Wading River scale drawings. Our new catalog completely illustrating each individual model contains 52 pages of live information and 24 of the latest models, also a full line of supplies for Model Building. Send 10c for your copy. Wading River Mfg. Co., 672 H Broadway, Brooklyn, N. Y.

American Made Toys.

An Opportunity for Home Workers on small scale and manufacturers on large scale to make American Metal Toys. Army, Navy, Machine Guns, Cannons, Warships, Indians, Cowboys, Wild Animals, Whistles, Bird-Whistles, Religious designs and other toys and novelties. Greatest chance for industrious people to have an independent business. Enormous demand for cheap toys offers unlimited field and great future all over United States and foreign countries. Experience or tools not necessary. Hundreds and more made complete per hour. Casting forms, complete outfit from \$3.00 up. We buy these goods paying fixed prices. Attractive prices offered for painted goods. A strictly business proposition. No one need apply unless he means business. Booklet and information furnished free. We have no sales agents and we warn against worthless and cheap imitations. Toy Soldier Manufacturing Co., 32 Union Square, New York.

Books.

Every Entertainer—Here's a valuable book. More than twenty real rough-rhyme recitations with a playlet of Love, Remorse and Revenge and these big, immortal poems: "Adventures of Abelard and Heloise," "Lustania" and "Miracle of a Mother's Heart." Pictures, 1920. Dazzler. Please all; Get these Happy Howls. The Trend Pub. Co., 652 Thirty-ninth St., Brooklyn, N. Y.

Why Pay Exorbitant Prices for your books? 20c. will bring you a wonderful little 64-page book on electricity, magnetism, wireless and etc. Describes fully how to make many interesting and instructive electrical experiments including the construction of batteries, electromagnets, induction coils, a small dynamo, motors, a current reverser, wireless telegraph apparatus and many others. Quality Book Shop, 506 S. 5th Ave., Maywood, Ill.

The Amateur Electrician. Pocket size, 20c. (coin). Joe Tillberg, Proctor, Vermont.

"Books for Sale." Send stamp for list. F. Saal, 28 Buchanan St., S. I., New York.

Be An Expert Card Player. The Celebrated Encyclopedia of games—price only 50 cents—tells you how. J. R. Kerr, Box 291, Brooklyn, N. Y.

4 Books. Seer A. C. Emmerich, Nativity, Egypt, Cana., 20c. Klein Co., Brandon, Minn.

Subscription Agents—Best magazine proposition. Make big money. Write for particulars. Concordia Magazine, 9-A Water St., York, Pa.

Nature Facts married and engaged people should know, concisely given, 25 cents. Central Sales, 801 Ninth Ave., New York.

Wanted—Rack issues of Radio Amateur News and Electrical Experimenter. Boston Magazine Exchange, 109 Mountfort St., Boston, Mass.

A Great Book. Seven wives. Seven prisons. Price 50 cents. Descriptive circular for stamp. J. R. Kerr, Box 291, Brooklyn, N. Y.

(Books—Continued.)

Books On All Subjects. New and second hand. Send for latest mechanical and scientific catalogue. The Bargain Book Store, 520 South State St., Chicago, Ill.

Help Wanted.

Stop Daily Grind. Start silvering mirrors, auto headlights, tableware, etc. Plans free. Clarence Sprinkle, Dept. 48, Marion, Indiana.

Earn \$25 Weekly, spare time, writing for newspapers, magazines. Experience unnecessary; details free. Press Syndicate, 5668, St. Louis, Mo.

Instrument and Meter Experts wanted everywhere. Our graduates earn big money. We train you to be meter engineer and hold responsible position. Write for our Special Offer. Fort Wayne Correspondence School, Dept. 405, Fort Wayne, Ind.

Be a Mirror Expert. \$3-\$10 a day; spare time home at first; no capital; we train, start you making and silvering mirrors, French method. Free prospectus. W. R. Derr, Pres., 579 Decatur Street, Brooklyn, N. Y.

Detectives Earn Big Money, Travel. Great demand. Experience unnecessary. We train you. Write for free particulars. American Detective System, 1963 Broadway, New York.

Business Opportunities.

Start Your Silver Fox Farm on monthly payments. For particulars address Stoskoff Black and Silver Fox Assn., Montague, Montana.

Turn Your Spare Time into money for that apparatus you want. Start a profitable, permanent home business. Steady weekly income. No investment but your brains and spare time. Positively no soliciting agency proposition. Write today. Address Opportunity, Box 175, Fredonia, N. Y.

I Represent a Firm established 50 years in high grade investment securities yielding 6% to 8%. Will call and give advice. Greater New York and vicinity only. C. H. Fuerstenberg, 404 West 43rd St., New York.

Substantial Manufacturing Corporation wants capable men to establish branch and manage salesmen; \$300 to \$2,000 necessary. Will allow expenses to Baltimore as explained. Address Mr. Clemmer, 603 N. Eutaw St., Baltimore, Md.

If You Want to Sell or exchange your farm, unimproved land, city property or patent, write me. John J. Black, 194th St., Chippewa Falls, Wis.

Health.

Tobacco or Snuff Habit Cured or no pay; \$1 if cured. Remedy sent on trial. Superba Co., SB, Baltimore, Md.

Pyorrhea (Rigg's Disease—Bleeding or Swollen Gums)—Hundreds have been helped by our successful home treatment. Purifying, healing, preventative. Full month's treatment, consisting of a very beneficial massage paste and an antiseptic tooth-cleansing paste to be used in place of your ordinary dentifrice, together with full directions for treatment, \$1 postpaid. Or write for free Booklet "R." Pyorem Mfg. Co., 439 Seventh St., Brooklyn, N. Y.

Miscellaneous.

Special Offer—Over \$50 worth of high class music for 50 cents. Stamp brings complete list. J. R. Kerr, Publisher, Box 291, Brooklyn, N. Y.

Learn Piano Playing By Ear in four lessons. Complete course \$1.00. Results guaranteed. Sterling System Studios, Mount Joy, Pennsylvania.

Boys—Start a collection of propaganda issued during the war; sets 50c. and 75c. Loren Hurl, Madison, Minn.

Electrical Tattooing Machine, \$3, \$5 and \$7. Catalogue for stamps. J. H. Temke, 1019 Vine, Exp., Cincinnati, Ohio.

Build Your Own Motorboat. Interesting work for boys. Send 50c. for a complete set of clearly drawn plans of a 21-ft. motorboat or cruiser including list of material required. A. Rank, 193 Grand Ave., North Bergen, N. J.

Big Mail Free! Just send your name. W. E. Fitzpatrick, Box 722, Chicago, Illinois.

News Correspondents.

Earn \$25 Weekly, spare time, writing for newspapers, magazines. Experience unnecessary; details free. Press Syndicate, 566 St. Louis, Mo.

Printing.

100 Name Cards, leatherette case, 75c. Agents 50% profit. \$5.00 daily. Information, Wolf, Desk J, Station E, Philadelphia.

Radio League Members—50 name cards with emblem of League printed, 45 cents; 100 letter-heads and envelopes with emblem, \$1.75. Printing Arts Press, 483 East 24th St., Paterson, N. J.

Phonographs.

Build Your Own Phonograph. Big saving. Blue prints, parts price list, instructions free. Associated Phonograph Co., Dept. R-N, Cincinnati.

Patent Attorneys.

Millions Spent Annually for Ideas. Hundreds now wanted. Patent yours and profit. Write today for free books—tell how to protect yourself, how to invent, ideas wanted, how we help you sell, etc. 301 Patent Dept., American Industries, Inc., Washington, D. C.

Postcards.

Everything in Postcards. Live-wire list free. Worth-while samples, 25c. Mention subjects preferred. Mutual Supply Co., Bradford, Pa.

Photoplays Wanted.

Write Photoplays; \$50 to \$300 each; experience unnecessary. Will send free plan upon request. Los Angeles Photoplay Co., Drawer 677, Los Angeles, Cal.

Photo Developing.

Film Pack Developed and 12 prints furnished for 35c., or roll developed and 6 prints made on postcards with fancy border design for 25c. Phil Lundsted, Cape Cottage, Maine.

Print Your Photos on Silk, very beautiful and attractive pictures. Send only \$1 for package of silk, prepared; postage prepaid. F. Israel Elizabeth, N. Y.

Rubber Stamps.

Rubber Stamps Made to Order. McCaddon Company, Zanesville, Ohio.

Stamps and Coins.

30 Different unused French Colonies, 25c. Catalog value, 65c. Austria 401-2, free with approvals. I. Samuel, 15 Putnam, Buffalo, N. Y.

Stamps on Approval to applicants furnishing satisfactory references. Big discount. Spencer, 294 Central Park West, New York.

40 Mixed German stamps, only quarter. H. S. Reynolds, Rising Sun, Md.

100 Different 16c. James Porter Co., Richmond Hill, N. Y.

500 Different Stamps, \$1.40; 200, 80c.; 100, 13c.; approvals. Michaels, 5600 Prairie, Chicago.

Free—40 Different stamps on application for approvals. Gordon Mallory, 1224 Leighton Ave., Anniston, Ala.

Free—Twenty United Stamps with 60% approvals. Enclose three cents. Illini Stamp Co., 8 West Madison, Chicago.

Song Poems.

Composing and Publishing Done. Send 25c. for beautiful waltz song. William Giles, Music Studio, Blanchard, Wash.

Song Writers' Manual and Guide sent free. Contains valuable instructions and advice. Submit song-poems for examination. We will furnish music, copyright and facilitate publication or sale. Knickerbocker Studios, 311 Gaiety Bldg., New York.

Scenery for Hire.

Collapsible Scenery for all plays. Ameka Grain, Philadelphia, Pa.

Stammering.

St-Stu-t-tering and Stammering cured at home. Instructive booklet free. Walter McDonnell, 121 Potomac Bank Bldg., Washington, D. C.

Electrical Supplies and Appliances.

Storage Batteries for audion filaments, etc. Guaranteed two years. 6 V. 40-60 amperes. \$16. 6 V. 60-80 amperes \$19. Immediate delivery. Dealers wanted. William Schick, 2723 Cooper Ave., Brooklyn, N. Y.

Water Locating by Mansfield's water finder is interesting and profitable. Particulars from Edwin Mansfield & Co., 94 Victoria Road, New Brighton, England.

For Advertisers.

Don't Experiment. White space is too costly. Let Jacobus write your advertising. Letters, \$8.50. Jacobus Advertising Service, 41 Bruen Ave., Irvington, N. J.

Chemicals.

Chemical Supplies. Specialty of dime packets. Send for list or state your needs. Also experimental apparatus. John Shekells, 1128 Carroll St., Baltimore, Md.

Send for Price List of Packets. Sets and supplies. Chas. Eberle, Phoenixville, Pa.

Correspondence Courses.

Dollars Saved. All kinds of used correspondence courses sold. (Courses bought). Lee Mountain, Pisgah, Alabama.

Novelties.

The Reliable Weather Prophet—Send 10 cents for me, hang me up. I will tell you when it will rain or shine. Particulars for stamp. National Specialties, 32 Union Sq., New York City.

Genuine Indian Baskets—Wholesale catalogue. Marion Gilhams, Highland Springs, California.

Office Devices.

We Buy for Cash, Rebuild and sell for about half new price, multigraphs, addressing machines, duplicators, etc. Don't be misled by firms infringing on our name. We are the original Office Device Company, 154-C West Randolph, Chicago.

Tricks, Puzzles and Games.

Special—Big Magazine 3 months, magic envelope, 6 crackerjack card tricks, package invisible ink, mystocode, 13 funny love letters, fortune telling chart, vanishing coin puzzle and catalogue of tricks, novelties, etc. All for 25c, postpaid. Order "Combination A9" Hermosa Specialty Co., 1627 N. Harding Ave., Chicago.

Telegraphy.

Telegraphy (both Morse and Wireless) and Railway Accounting taught quickly. Tremendous demand. Big salaries. Great opportunities. Oldest and largest school; established 46 years. All expenses low—can earn large part. Catalog free. Dodge's Institute, M. St., Valparaiso, Ind.

Wireless.

Storage Batteries, 6 volt, 95 ampere hour, \$32. 4 volt, 60 ampere hour, \$22. They are ideal batteries for filament lighting, induction coil operation, motor car and motor boat, etc. Shipped same day order received. Pepper & Harkison, Lemoyne, Pa.

Attention—3" enameled dial, raised graduations, 50c.; contact points with screw, 20c. per dozen; postage extra. Wireless instruments, parts, material, educational books, etc. Price list ready. Stratton Electric Co., 215 Federal St., Greenfield, Mass.

Genuine Double Filament Audiotron at \$5.50 postpaid and insured to arrive in perfect condition to any address. Your last chance to get the genuine double filament audiotron detector, oscillator and amplifier, vacuum tube because the Audiotron Company are manufacturing the one filament type only, and selling them for \$6. Remember all restrictions were taken off these genuine audiotrons. Order now and no more than three to one person. To insure prompt shipment on same day your order is received, then send only money orders to Audiotrons, Box 18, Station W, Brooklyn, N. Y.

Amateurs—Get one of our vacuum tube detectors and amplifiers. Vacuum tube detectors, consisting of a standard vacuum tube socket, grid condenser, grid leak and rheostat all mounted on XX Bakelite panel. Price mounted, \$6.50. One stage amplifier same as above except grid leak and condenser are replaced by an amplifying transformer, 8.50. Taf. Radio Co., 293 N. Main St., Wilkes-Barre, Pa. Better "B" Batteries, \$1.25.

Experimenters—Unused equipment for sale, including 2", 1" coils, 4 Edison wet batteries, 1/16 H.P. motor-generator, telegraph keys, sounder, relay, detector and many other instruments. Write for prices. L. D. Thompson, 6546 Woodlawn Ave., Chicago, Ill.

(Wireless—Continued.)

Individually Tested Galena Crystals, 40c. each. H. S. Reynolds, Radio Station, Rising Sun, Md.

Selling Out—Audion cabinets, tubes, condensers, turners, wire, switches, miscellaneous parts. Will make audion panels to order. R. A. Krauss, 4936 N. 12th St., Philadelphia, Pa.

Q. S. T. Amateurs—Our special offer this month is the well known brand of "ACE" products, and for one month we are giving a discount of 5% off list prices and we will ship all goods prepaid east of the Mississippi, furthermore all are sold with a money-back guarantee. We also carry complete radio-telephone equipment. The wise modern up-to-date amateur writes to us and lets us quote them prices on the equipment they need and practically every case they buy. We have yet to have a dissatisfied customer. Send in your list and let us quote you. Radio Mail Order Supply Co., 533 West End Ave., New York City.

Good Radio Receiving Sets, \$8.50 and Up. Panel transmitting sets, \$30.95 and up. Radio-telephone apparatus, wire, supplies of all kinds. Catalog 6R for two-cent stamp. Pocket code card free. Jenkins, 923 Purchase St., New Bedford, Mass.

Audion Control Unit—Bakelite panel on which is mounted a V. T. socket, grid condenser, rheostat, grid leak, B bat., and six binding posts. Price \$8.00. Telephone cords, 4 and 5 conductor, 6 ft. long, at 45c. each. High potential mica condensers, .002 and .005 approx. capacity at \$1.25 and \$1.50 each. Postage extra. Haupt Elec. Supply Co., 2442 Ogden Ave., Chicago, Ill.

Dead? Your "A" battery was mean. Always ready if you use our R-B Battery Booster. Charges your battery overnight for 10c. Soon pays for itself. Every amateur needs one. \$15.00. It's ready to ship you. Hi Co., Marion, Ill.

Switch Levers 50c., Audion control panels \$10. Two-stage amplifiers \$35. Sets made to order. Rheostats, sockets, tubes, binding posts and all standard radio apparatus. Jerome Haas, 2011 Atlantic Ave., Atlantic City, N. J.

Bargains in Wireless Equipment. The following materials which we list below are all produced by well known makers of radio equipment and we offer them at the prices listed below for immediate delivery from stock f. o. b. New York. No c. o. d. orders or orders less than \$1.00 accepted. Murdock head telephones with head band, 3,000 ohms, \$4.95; No. 18 annunciator wire for connections in 1/2 lb. coils, packed in individual cartons, per box, 30c.; No. 12 hand drawn antenna copper wire, put up in coils of 200 feet each, per coil, \$1.50; screw drivers, 3 1/2 in. long, 2 in. blade, ebony handle, 8c.; 5 in. stamped pliers with cutting off attachment, 19c.; mounting panels and base boards for DeForest 3-panel beginners' unit sets, per set, \$1.80; mounting panels and base boards for the DeForest 6 panel audion unit radio receiver, per set, \$3.40; black Japanned shelf brackets 8x10 for mounting panels and base boards, per pair, 30c; friction tape in 2 oz. rolls, wrapped in tin foil, per roll, 10c.; complete ground outfits, consisting of one 600 volt 100 amp. Trunbull switch on composition waterproof insulating base; 25 ft. of No. 4 gauge weatherproof wire; 6 one-wire porcelain cleats and one ground clamp, \$5.25. Chas. Gilbert, 1415 Sedgwick Ave., New York City.

Amateurs! We have a complete line of wireless apparatus. Send stamp for circulars. G. L. Wireless Supply Co., Arlington Heights, Illinois.

Radio Operators—A set of warnings, etc., signs needed in every amateur or commercial wireless station, printed upon durable cardboard. Sent postpaid for 20c. silver. H. S. Gates, "Radio Stationery," 123 Richard St., Auburn, Rhode Island.

New Instruments for your set. Beginning radio. Try us. Audion panels, \$13.50; loose couplers \$4.50 up; variometers, \$5; oscillation transformers, \$10; grid condensers, 50c.; amplifiers, \$9 to \$20; tuners, crystal detectors, phone condensers, etc. Sets and instruments made to order. Our motto is "play fair with the amateur." Write us your needs. We quote you prices. Foothill Radio Shop, Office 1117 Foothill St. South Pasadena Calif. Factory 1737 Mission St., South Pasadena, Calif.

Amateurs' Attention. We are now able to furnish the famous new "Fasco Honeycomb Coil Mounting" for cabinets or unit panels. A few good points about these mountings, solid bakelite, solid construction, expert workmanship, fine tuning, and no body induction since we employ our new extension levers. Satisfaction guaranteed. We ship within 24 hours after receipt of order. No c. o. d. Be a Fasco booster in your town. Fasco Radio Apparatus. Mr. M. Schneider, 112 Weld St. Rochester, N. Y.

Panel Mounting Bargains. Four 43 plate condensers, capacity .001 with pointer, scale and knob \$2.90 each. Four Perfection 10 ohm rheostats 75c each. One S. C. R. 54 primary and secondary complete with scale knob and pointer \$2.50. Joseph Fairhall, Jr., Electrical Machine Shop, Danville, Ill.

Special—Complete set of variometer parts \$5. Variometer parts (wooden), \$2.50. Audiotron panels, \$8. Double filament audiotrons, \$6. Send stamp for circulars. G. L. Wireless Supply Co., Arlington Heights, Illinois.

(Wireless—Continued.)

Q. S. T.—Amateurs! We have a few Western Electric VT-1, \$10; two filament audiotrons, \$6.10; Marconi and Moorhead VT-1 and VT-2, \$7.10; Murdock 43 plate variables at old price, \$5.50; audiotron adaptors, \$1.50 and other bargains. Write quick. The Coastal Radio Co., 301 Second Ave., Asbury Park, N. J.

All Amateur Apparatus bought or made in accordance with The Radio Buyers' and Builders' Handbook invariably re-sells very profitably. Study my June and July display advertisements in Q. S. T., see why, and get your copy now. R. Clark, Barnes Rd., Newton, Mass.

DeForest Honeycombs and double mountings 20% off. Galena receiver \$3. Marconi bulbs \$5. Control panel \$5. Coupler \$5. Vibroplex \$5. Fixed condensers, variables, keys, detectors, sockets, phones and other apparatus. Particulars for stamp. James Zimmer, 81 Carman Ave., Lynbrook, N. Y.

The A & S Radio Laboratory. Slightly used wireless equipment at bargain prices. 4000 meter loose coupler, \$9.00; Holtzer Cabot phones, \$6.00, etc. 669 East 23rd St., Paterson, N. J.

Send Twenty-five Cents for plans of complete crystal receiving set. "Radio", 110 Park Row, New Orleans, La.

Bakelite Panels, 3/16 thick, 2 1/4 square inch, standard switch knob-lever, 35c; switch points with screw, 2c; points with threaded shank and nut, 8c. Few stamps brings catalog all parts. Electric Novelty Shop, 10 Fifth Ave., Charlotte, N. C.

Welding.

Oxy-Acetylene Welding Machine. Geo. C. Schemmel, Wapakoneta, Ohio.

Exchange.

For Sale—Ranger Motorbike, new. \$25. Cost \$55. Money refunded if not satisfactory. Donald Nelson, 403 Beacon St., Lowell, Mass.

For Sale—DeForest audion Panel P-402. Thirteen dollars. Cabinet tuner with three Treco coils, range 150 to 20,000 meters, 3 Murdock condenser audion control mounted on 18" x 24" formica panel, \$45.00. DeForest audion panel, type P-500, \$17.00. Thirty-five hundred meter loose coupler, \$5.00. Knapp dynamotor, type S.S., \$5.00. Ray Thompson, Canton, S. D., Route 5.

Bargain—Receiving cabinet, detector, loading coil, phones. Complete, twenty-five dollars. Call, write. Joseph A. Courtade, 215 Kent St., Greenpoint, Brooklyn, N. Y.

Wanted—1/2 K. W. Amrad (Quenched Gap). W. Robert Dresser, Calais, Maine.

Will Trade 6-volt generator motor, 50 volt alternating magneto generator for wireless apparatus. Jack LeFerre, 714 S. 20th St., Lafayette, Indiana.

Wanted—Duck's new Navy type receiving transformer in good condition in exchange for new Savage 22 repeater military model, perfect condition. A Hartman, Chittenden, Calif.

Exchange—One Excelsior motorcycle engine. Excellent condition. Ready to run, for good receiving cabinet and phones. Edgar B. Cones, 305 A St., Lawton, Okla.

Exchange or Sell—Indian motorcycle, one cylinder, 4 H. P. engine is in excellent condition, for high class receiving outfit with V. T. or sell for \$45.00. Ralph Petranek, Muscoda, Wis.

For Sale—Sheet silicon steel for transformer cores. In sheets 25" x 6", 10 cents per pound. Smaller sizes at same price. Send us your needs giving sizes, we may have them. R. D. Weaver, 222 Wiggins St., West Lafayette, Ind.

For Sale—The large receiving set used by Station 2QR, as illustrated in a former issue of RADIO NEWS, consisting of Detector and three stage amplifier, all contained in large 18 x 28 hardwood cabinet with Bakelite front panel, all DeForest instruments, including full equipment of each size of honeycomb coils. This outfit is a beauty and in perfect working condition and cost \$250 to build. Will take \$150 cash for same, or send \$50 and balance C. O. D. Guaranteed perfect condition. Selling because of installing radio-audio set. Hugh Robinson, No. 13 Walnut St., Keyport, New Jersey.

Exchange—Mignon R. C. 1, universal crystal detector, and buzzer for two .001 mfd variables for panel mounting. G. K. Tyson, 605 W. Illinois St., Urbana, Illinois.

For Sale—Complete receiving set. 3000 meter Halcon coupler, \$19.00. Brands 2800 ohm head set, \$8.00; two Murdock .001 M.F. variable condensers, \$4.50 each; 104 plate balanced Navy type variable condenser, \$10.00; Halcon Audion Panel, \$15.00. Audiotron double filament detector used 200 hrs., \$4.50; Marconi V. T. new, \$6.50; V. T. Base, \$1.00; Halcon 45-volt B battery, \$2.00; Murdock antenna switch, \$3.50; Marconi loading inductor, \$3.50; 3500 meter loose coupler, \$6.00; tuning coil, \$1.50; 2 Murdock connection blocks, 25c each; 2 Murdock fixed condensers, 50c each. These articles have only been used a little while. The most of set is new. John Breeding, Saratoga, Calif.

(Continued on page 342)

(Continued from page 341)
(Exchange—Continued.)

Sell Cheap—DeForest Receiver type two hundred. Cost seventy-seven dollars. Complete set honeycombs mounted. Pair Brandes Superiors. Pair Western Electrics. Rotary gap Direct, Alternating. Fifteen dial Omnigraph. Two, ten-Ohm rheostats. Fifty feet ground wire. Charles MacCarron, 250 Radde St., Long Island City, New York.

For Sale—\$12.00 Omnigraph for \$6.00. Other radio articles. Winkler, 1332 First Ave., New York.

For Sale—Complete 1 K.W. spark transmitting set, now used by Station 2QR, as illustrated in former issue of Radio News, consisting of 1 K.W. Thordarson, Dubilier condenser, International OSC transformer, Clapp-Easthan rotary gap, line protector, ampere meter, rheostat, change-over switch and key. Cost \$180. Will take \$130, complete. \$30 cash, balance C. O. D. Selling because of installing CW set. Hugh Robinson, 13 Walnut St., Keyport, N. J.

Bargain—Half-kilowatt transformer and fuse cutout, \$10.00. 25 glass plates tinfoil, \$2.00; 12-volt storage battery, \$10; Navy coupler audion panel, \$8; D. P. D. T. Half throw, \$1.00; Heavy key, 10-A, \$1.50; Crystaloi, \$1.75; Brandes headset, \$5.00; Omnigraph No. 2, \$10.00; Aerial copper, No. 12, \$1.50; detector, 75c. Switches, copper ribbon and sheeting and junk, complete, \$48.00. All letters answered. J. Weaner, 402 So. Main St., So. Bend, Ind.

For Sale—Arlington receiving transformer, \$8. Brandes superior phones, \$4.50; Crystaloi detector, type AA, \$4.50; Turney buzzer, 50c. Joseph Victor, 654 Burke Ave., New York.

Radio Telephone D.C. generator takes 30 volts at 3 amperes; D. C. delivers 350 volts at 80 miles, for sale, \$60. France rectifier, \$10; 1/4 H. P. Robins & Myers A. C. motor, \$20. Write Raymond Ulrich, 17 Courier St., Rutherford, N. J. Call or phone 892-R.

Wireless for Sale. List free. Harry Tice, Oak St., Newburgh, N. Y.

For Sale—New \$40 Lyric Liberty cornet for \$30. Edw. C. Schurch, 501 S. Grand Ave., Bozeman, Montana.

For Sale—Western Electric transmitting bulb, \$8.00; 10,000 meter coupler, \$10.00. Write for particulars. W. Schimels, 1430 So. Harding Ave., Chicago, Ill.

Moving Picture Cameras. \$20. Hetz, 302 East 23rd St., New York City.

Acousticon for Sale or Swap. W. Smith, Rockaway Road and Grape St., Jamaica, L. I.

Have Several Good Storage Batteries used only short time. Will exchange for wireless apparatus. B. C. Smith, Seymour, Indiana, Box 237.

For Sale—1 1/2" spark coil, \$6.00; 1 1/2" spark coil, \$2.00; glass plate condenser, 75c; spark gap, 75c; 1,000 meter loose coupler, \$4.00; Universal detector (uses galena and silicon) \$2.00; Galena detector, \$1.25 and .001 M.F. Murdock variable condenser, \$4.00. Write at once. Clinton Smith, Wakeman, Ohio.

For Sale—Voltmeter, ammeter, loose coupler, antenna, insulators, rheostats, phones, detector, switch point—levers, fixed and variable condensers, aerial and lightning switches. First \$40.00 takes everything. H. G. Reuther, R.R. 14, Dayton, Ohio.

For Sale—4000 meter receiving transformer, crystal detector, 6000 meter long wave inductance coil, 21 plate variable air condenser. Nearly new, \$13.00 for all. Hugo Reinhold, Edgemont, S. Dak.

Bargain—Electrical Experimenters, Radio News, Popular Mechanics, Motors, etc. Write. George Pankovich, 755 Franklin St., Trenton, N. J.

Let's Swap! Buy! Sell! What'd've got? What'd've want? Dime quarterly. National Exchange Medium, Detroit.

Will Purchase two DeForest tubular audion adapters. H. S. New, West Orange, N. J.

First M. O. for \$30 take 1/8 H. P. motor, G. E. make, and gap, \$20 for motor alone. I. A. Nerher, 41 Beattie Ave., Lockport, N. Y.

Trade—One Electron Relay, 7 DeForest coils with triple coil mounting, 3 Var. condensers, 3200 Ohm phones. For good Kodak with Anastigmat lens. W. H. Millmore, 418 2nd Ave., San Francisco, Calif.

Wonderful Omnigraph with 15 dials, largest size sell \$28.00 at the Omnigraph Co., will be sale with a sounder and telegraph key. All for \$25.00. G. Martineau, 242 Stadacona, Montreal.

Sell or Trade—Electro Imparting Co. 3" spark coil, gap, variable sending condenser, and fixed condenser for \$18; Manhattan 500 ohm relay, \$2; Bunnell sounder, \$2; Western Electric Co. key, \$2; Weston Ampere meter, 30 amp., \$2; Western Electric Co. 8" 110-volt A. C. fan, \$7; telephone, \$2. All cost \$55 new. Will trade for receiving instruments. Make offer. Nickolas Mitchell, 235 S. 25th St., Paris, Tex.

For Sale—Nearly new 15 dial Omnigraph with Morse dials Cost \$26; sell \$11, cash. H. A. Moyer, Martinsville, New York.

Lathe For Sale. Goodell-Pratt lathe with attachments. New. Will sell at good discount. V. H. Laughter, Byhalia, Miss.

(Exchange—Continued.)

For Sale—1 set "Hawkins Guides", \$6.00. 1 guitar, good condition, \$8.00; 1 Marconi V. T. (new), \$5.00; 1 Mignon undamped wave receiver. Cost \$100, will sell for \$45 less bulb and B bat. Must sell. Alfred Mihachik, Freehold, N. J.

I Have For Sale a double slide tuner, \$4.00. Also complete receiving set, \$10, good for at least 100 miles; good set for the beginner. McLaughlin, 530 W. 152nd St., New York, N. Y.

Hams—Navy type coupler in cabinet. Loading coil and condenser in same cabinet. Price, \$18; Radioson detector, \$4.50. Both brand new. Never used. Daryl McClung, 1221 9th Ave., Huntington, W. Va.

Wireless Outfit For Sale. One-half K. W. transformer, rotary gap. Large receiving cabinet. Also aerial. Fred Miller, 1902a Victor St., St. Louis, Mo.

Sell New \$24.50 Amrad half K.W. quenched gap, excellent condition, \$18. Wanted: Large Dubilier condenser. Must be in good condition and cheap. Edward C. Jones, Jr., Fairmont, W. Va.

Here's Your Chance. Marconi loose coupler, 3500 meters, \$16.50; fine 6000 meter loading coil, \$4.50; .001 variable condenser, \$4; .0005, \$3; Electro 1/2-K.W. transformer coil, \$6; large helix, No. 6 wire, \$3; Crystaloi, \$2.50; change-over switch, 1/1; two 1/2" spark coils, \$2 each; key, \$1.50; stationary gap, 50c; "Model" printing press, 6" x 9" chase, complete with new type cases, composing stick, rule, paper, \$70. Wilbur E. Gemmill, 132 Jefferson Ave., York, Pa.

Must Sell My Station. 43 plate Murdock variable condenser, \$3; 23 plate Murdock, \$2.50; DeForest three-coil honeycomb mounting, \$2.50; Western phones, \$10; Western variable condenser, \$7; 3500 meter Navy type coupler, \$15; Jove detector, \$1; Murdock potentiometer, \$1; brand new V. T. 1, \$6; 1/2-K.W. Packard, \$10; rotary gap, \$12; Murdock oscillation transformer, \$3; key, \$1.50. You pay postage. Money talks. Joseph Lapice, 1218 So. Harding Ave., Chicago, Illinois.

For Sale or Trade E. I. Co. Nuen cabinet De Luxe. Guaranteed in same condition as new. Has been used 2 months. Price, \$35. Write Box 284, Willisca, Iowa.

For Sale—Transmitter—3/4-K.W. Thordarson. Thordarson oil condenser; Chambers rotary gap; Thordarson O. T., Navy key, rheostat for rotary. Set mounted in hardwood cabinet. In good condition, \$75 complete. Receiving transformer—20,000 meter, \$20. Other long wave apparatus. One Goodell Pratt bench lathe, \$25. Photos and description on request. Selling out to go to school. Write Radio 9GK, Box 137, Ottumwa, Iowa.

Bargain—Slightly used motor driven auto horn, \$3; G. E. 30-V., 10A. 1/4-K.W., D. C. generator (without base), \$25. Co. \$60. Telephone ringers, \$1.25; new Ford motometer, \$2.25. Write Paul Hoffman, Jackson, Mo.

For Sale—Loose coupler, 4000 meter. Hand made. Walter Huber, Bunker Hill, Ill.

Sell—Professional coupler, \$8.50—never used. Robert Holman, 637 East Mahanoy St., Mahanoy City, Pa.

For Sale—One National automatic telegraph transmitter, almost new. Splendid condition. Supplied with 26 Continental and 50 Morse records giving over thirty thousand practice words—a bargain. Hill Gara Co., Hidalgo, Texas.

Wanted—An omnigraph 5 or 15 dial. State particulars. Write Norris Glasco, Northfield, Minn.

For Sale—Complete qualitative chemical analysis outfit; one-inch spark coil, \$2.50; chemical and electrical books; Erector electrical outfit, \$3.50; telegraph relay, \$1; motors, 75c. Write F. A. Fletcher, Warner St., Hudson, Mass.

For Sale—\$75 I. C. S. chemical laboratory, never used, \$50; 1 set Hawkins Guides, \$7; 20,000 meter loose coupler. \$15; 1/2-K.W. Packard transformer, \$15; Thordarson 8 point rotor and standards, \$5; 2 LRD-3-1200, 2 LRD-3-750 Radisco coils, \$7, all new; 120V-1.2A, DC generator, \$5; 30 V-DC generator, \$3. Ira F. Coon, 526 E. 4th St., Lockport, Ill., Box 333.

For Sale—Complete Arlington receiving set, dirt cheap. Write George Conroy, Lake Geneva, Wis.

Omnigraph. No. 5, brand new. 23 dials, total cost \$15. Will sell for \$9. Rochester Clarke, Elizabeth City, N. C.

Genuine "Jupiter" Aerial Wire. Seven strands No. 22 solid copper. 100% conductivity, 1 1/2c per foot, \$12 per thousand. No C. O. D.'s. 15 pounds per 1,000 feet. Send postage. Lee A. Bates, 8 Moen St., Worcester, Mass.

Exchange No. 2 Jr. Omnigraph, \$15.00 DeForest Fixt Variable, \$4; 2-23 plate variables, \$3.50 each; 1-43 plate variable, \$3.50; rheostat, \$1; coils, Nos. L-25, \$1; L-35, \$1; L-75, \$1.25; L-100, \$1.85; L-250, \$1.75; L-300, \$1.85; L-400, \$2; L-750, \$2.50. Want regenerative receiver. E. F. Key, Charleston, Washington.

For Sale—Vt. 1 with base, \$5.00; Murdock 3000-ohm set, \$4; 2" spark coil, produces 2 1/2", \$10; 2 to 20-volt variable transformer, \$4; regenerative cabinet sets 1 x B and K.I.O. loud, \$18. All A-I shape. Money order starts immediate shipment. J. M. Coates, 26 John St., Lockport, N. Y.

(Exchange—Continued.)

For Sale—Complete amateur radio station. Richard Bohannon, Boonville, Indiana.

Bargain—20,000-volt oil condenser, \$7.00; step-down transformer, \$3; mahogany cabinet, \$2; detector unit complete with "B" jattery, \$11; sensitive audiotron, new, \$4.50; rotary disc, \$1.50. Paul Barrett, 222 N. Dunn St., Bloomington, Indiana.

Electrolytic Interrupter and 1/2 K.W. transformer coil, \$8; \$22 mandolin, \$15. All excellent condition. Earl Cook, Bernardston, Mass.

Compelled to Sell 1 Murdock 1500 meter coupler, \$10; 1 Turney vario variable condenser, \$10; 1 Mesco detector stand, \$4; 1 3000 meter Murdock loading inductance, \$2; 1 fixed condenser, 75c.; 1 Century buzzer, \$1; 1 1/2" spark coil, \$2.50; 1 Marconi gap, \$7.50; 1 Federal amplifying transformer, \$5. Write for particulars. Sold separate or together. First money order takes the instruments. All these instruments are in A-1 condition; having had hardly any use. John C. Blair, Sound Beach, Conn.

For Sale—1 step amplifier receiver in good condition. 1,000 mile range, all variables mounted on bakelite front, other instruments enclosed in mahogany cabinet, complete with two audiotron bulbs B. batteries, condensers, coil, etc. Value \$110.00. Our price \$70.00. One new 65 ft. aerial complete with 4 strands copper wire, insulators, etc., \$8.50; new crystal panel detector, \$3.75; new variable air condenser, capacity .0005 M. F. D., \$5.00; Audion detector, \$10.00, enclosed in cherry wood cabinet. Beecher Radio Club, Beecher, Ill.

For Sale—Complete 1/2 K.W. transmitter, Rotary gap; Universal R L C 5 receiver, detector and phones. Sold as a set or parts. Write J. Win. Anderson, East Tawas, Mich.

Complete Receiving Set, cabinet style 3,000 meter, loose coupler, 3 variable condensers, 2 loaders, Marconi V. T., resistance socket—grid leak B-battery and Murdock phones, \$60. Fred Bohn, 152 E. 94th St., New York City.

For Sale—Large used 220 V., D. C. fan, in fair condition, \$12. 8 new 1/4-K.W., 5000-volt transformer secondaries with directions for making transformer, \$4.00 each. Slightly used triode amplifying transformer, \$5.50. Small Knapp battery motor, \$1.75. Particulars for stamp. R. D. Weaver, 222 Wiggins St., West Lafayette, Ind.

For Sale—New 2,000 to 20,000 meter tuning cabinet, \$13.00. New 3,500 meter selective coupler, cabinet type, \$8.00. Lester Wertz, Temple, Pa.

For Sale—Mignon RW3, perfect, \$60; Traco coupler, \$15; Duck's No. 16X hydro-electric set, \$10. All for \$80. Might trade, but no junk wanted. F. H. Ransford, Dalton, Mass.

For Sale or Trade Mignon U. W. I. Un-damped wave tuner, new, and B. D. I. Detector, cost \$60, sell \$35 cash, or trade for two-stage amplifier. W. H. Corvey, Fulton, Mo.

For Sale or Exchange. German army 2000 ohm radio headset for \$2. Omnigraph \$15 Eastman Kodak for 2" coil. Also Emlen Bros. self-heating gasoline soldering iron. Alex Serna, Lehigh, Okla.

A Complete Receiver with Audion and one-step amplifier mounted in single highly polished mahogany cabinet, all metal parts nickel-plated, for sale at reasonable figure. Also noiseless 1/2-K.W. transmitter complete with Murdock condensers and rotary but minus oscillation transformer, mounted in cabinet with glass doors. Must be seen to be appreciated. Excellent opportunity for Radio Club. Inspect week days between 6 and 7:30 p. m. or Sunday morning. Edwin K. Cohan, 601 W. 156th St., New York City.

Wanted—Complete wireless outfit. Must be in good condition. Give name of all parts and details, etc. Will pay \$50 to person selling out. Jno. Sawickas, Station C, Worcester, Mass.

Sell—Developing apparatus, chemical apparatus and cameras. Send 2c stamp for list. Will trade for wireless apparatus. Arthur, 3428 Evergreen Terrace, Baltimore, Md.

Exchange—Powers' moving picture machine and films for two-stage audion receiving outfit. Answer by mail only. A. Washborit, 277 W. 11th St., New York.

Spark Coils with vibrators, \$2.00; telephone condensers, \$3.00. Can be used on coils; powerful telephone magnetos, \$1.75; plugs, \$5.00; telephone transmitters, \$7.50; receivers, \$5.00; 50 ohm telegraph sounder, \$7.50. Send for sample binding post and list of bargains, 10c. No junk. Sidny Bernstein, 3242 Ogden Ave., Chicago, Ill.

Sell—Erector set, \$12.00; chemical outfit, \$23.00; receiving set, \$16.00; high tension insulator, \$4.00; Practical Aeronautics, \$1.50; developing outfit, \$5.00; model yacht, \$25.00. Theodore Stahl, 625 McKerchey Bldg., Detroit, Michigan.

For Sale—Audion panel and omnigraph. Write for description. Walter Johnson, 512 Mosby, Richmond, Va.

For Quick Sale—Benwood gap, new, \$22.00; 1/4-H.P. motor, single phase, 1750 r.p.m., new, \$22.00; Omnigraph, good condition, 4 Continental dials, \$8.00. Want Grebe RORR two-stage amplifier. Harold Smith, Charleroi, Pa.

For Sale—General Radio 169 Vernier, mounted on 124A condenser, \$10. E. Otto, 2355 Concourse, N. Y.

MAGAZINE Prices Slashed

Millions

of magazine subscriptions expire this month! With the tremendous advance of paper prices and labor it is certain that nearly all magazines will advance their subscription prices at least from 25% to 50%.

BY ORDERING NOW YOU WILL SAVE BIG MONEY.

In announcing these wonderful prices it is with the absolute knowledge that our readers are offered the lowest prices for standard Magazines that it is possible to obtain anywhere. Only by special arrangement with the publishers are these prices possible, but to take advantage of them, you must act quickly. Don't delay, do it now. This offer is so good that of necessity it must be limited in time. Just think of buying standard Magazines at reduced prices in time for Xmas Presents, and they certainly make ideal gifts being a constant reminder for a whole year of a considerate friend. Just glance over our wonderful prices, and see how we enable one dollar to bring you two dollars' worth, and then make up your list. When sending your order, don't forget to state

where magazines are to be sent. But be sure you do it now. To-morrow means you may forget and lose this wonderful opportunity. All prices quoted are for subscribers in U. S. A. only, Canadian and Foreign subscriptions require additional postage.



**The
Publishers
Will Mail the
Magazine
Direct From
Their Own
Office to You.**

Science & Invention ... \$3.00
Popular Science 3.00

Regular Price \$6.00

**Our
Price
\$5.75**

Science & Invention ... \$3.00
Scientific American.... 6.00
Illustrated World..... 3.00

Regular Price \$12.00

**Our
Price
\$11.50**

Science & Invention... \$3.00
American Magazine... 2.50
Woman's Home Comp'n 2.00

Regular Price \$7.50

**Our
Price
\$7.25**

Science & Invention ... \$3.00
Etude for Music Lovers. 2.00

Regular Price \$5.00

**Our
Price
\$4.50**

Science & Invention ... \$3.00
Everybody's Magazine.. 2.75
Delineator 2.50

Regular Price \$8.25

**Our
Price
\$8.00**

Science & Invention ... \$3.00
McCall's Magazine..... 1.50

Regular Price \$4.50

**Our
Price
\$3.50**

Science & Invention ... \$3.00
Today's Housewife 1.00

Regular Price 4.00

**Our
Price
\$3.50**

Science & Invention ... \$3.00
Wireless Age..... 2.50
Radio News 2.00

Regular Price \$7.50

**Our
Price
\$6.75**

Science & Invention ... \$3.00
Boys' Life 2.00

Regular Price \$5.00

**Our
Price
\$4.50**

Science & Invention ... \$3.00
Illustrated World..... 3.00
Radio News..... 2.00

Regular Price \$8.00

**Our
Price
\$7.25**

Science & Invention ... \$3.00
Field and Stream..... 2.50

Regular Price \$5.50

**Our
Price
\$5.25**

For computing together Magazines listed separately, add Class Numbers before title and multiply by 5, giving our price to you in dollars and cents.

Write for Special Prices on ANY Publication not listed here.

We will save you money

Special Clubbing Prices of Science and Invention WITH:

Club No.	Magazine	Regular Price	Our Price	Club No.	Magazine	Regular Price	Our Price
80	Adventure	\$4.00	\$6.75	37	Modern Priscilla	\$2.00	\$4.60
50	American	2.50	5.25	60	Munsey's Mag'zn	3.00	5.75
35	Boys' Life	2.00	4.50	30	McClure's Mg'zn	1.65	4.25
35	Christian Herald	2.00	4.50	70	Outing	4.00	6.25
80	Cosmopolitan	4.00	6.75	50	Pictorial Review	3.00	5.25
100	Country Life	5.00	7.75	60	Popular Science	3.00	5.75
75	Current History	4.00	6.50	35	Radio News	2.00	4.50
50	Delineator	2.50	5.25	120	Scientific Am'n	6.00	8.75
40	Designer	2.00	4.75	70	Smart Set	4.00	6.25
55	Everybodys	2.75	5.50	15	Today's Housewife	1.00	3.50
35	Etude (for Music Lovers)	2.00	4.50	45	Wireless Age	2.50	5.00
50	Field & Stream	2.50	5.25	40	Woman's Home Companion	2.00	4.75
60	Garden Mag'zine	3.00	5.75	50	Youth's Comp'n	2.50	5.25
55	Illustrated World	3.00	5.50				

SEND ALL ORDERS TO "CIRCULATION DEPARTMENT"

EXPERIMENTER PUBLISHING CO., Inc.
233 Fulton Street, New York City, N. Y.



RADIO APPARATUS

*Distributors of Reliable Radio Apparatus
to Schools, Colleges and Experimenters
All Over the World!*



"PITTSO"

The sign of service and prompt delivery.

All we ask is a trial!

"REMEMBER"

When you say "PITTSO" you think of everything in radio!

AMPLIFYING TRANSFORMERS

No. A-2 Acme mounted.....	\$7.00
No. A-2 Acme semi-mounted.....	5.00
No. A-2 Acme unmounted.....	4.50
No. 166A General Radio, mounted.....	7.00
No. 166A General Radio, semi-mounted.....	5.25
No. 166A General Radio, unmounted.....	4.50
No. Z-73 Clapp Eastham, mounted.....	6.00
No. Z-73A Clapp Eastham, unmounted.....	4.00
No. 226-W Federal.....	7.50

F. D. PITTS CO., BOSTON, MASS.

AMPLIFIERS

No. RORE Grebe one step.....	\$25.00
No. RORG Grebe Det. and one step.....	47.00
No. RORK Grebe two step.....	55.00
No. RORD Grebe Det. and two step.....	75.00

F. D. PITTS CO., BOSTON, MASS.

"B" BATTERIES

No. 766 Ever-ready 22.5 V., large.....	\$3.50
No. 763 Ever-ready 22.5 V., small.....	2.25
No. 7623 Standard 22.5 V., large.....	2.40
No. 7625 Standard 22.5 V., small.....	1.35
No. 7650 Standard 22.5 V., variable.....	3.25
No. P-3 Ever-ready flashlight batteries set of ten, 45 V.....	3.50

F. D. PITTS CO., BOSTON, MASS.

BUZZERS

No. 178A General Radio HI-tone.....	\$2.00
No. Y-744 Clapp Eastham HI-Freq.....	1.75
No. P-6 Century HI-Freq.....	2.50
No. 9010 Watch-case brass HI-pitch.....	.75
No. 9011 Watch-case nickel-plated, HI-pitch.....	.75

F. D. PITTS CO., BOSTON, MASS.

COILS (De Forest Due-lateral)

DL-25.....	\$1.65
DL-35.....	1.70
DL-50.....	1.75
DL-75.....	1.85
DL-100.....	1.95
DL-150.....	2.10
DL-200.....	2.20
DL-250.....	2.30
DL-300.....	2.45
DL-400.....	2.60
DL-500.....	2.75
DL-600.....	3.05
DL-750.....	3.30
DL-1000.....	3.55
DL-1250.....	3.85
DL-1500.....	4.10

F. D. PITTS CO., BOSTON, MASS.

COIL MOUNTINGS (De Forest)

No. LC-100 with gears unmounted.....	\$10.00
No. LC-101 with gears mounted with base.....	13.00
No. LC-201 with base and Pri. switch.....	15.00
No. ULC-200 Single coil mounting.....	2.00
No. ULC-300 Double coil mounting.....	4.80
No. ULC-400 Triple coil mounting.....	5.60
No. ULC-100 Same as LC-100 but on panel.....	10.75

F. D. PITTS CO., BOSTON, MASS.

CONDENSERS (Variable air) DE FOREST

No. CV-500 unmounted .0005 Mf.....	\$6.25
No. CV-500A unmounted .0005 Mf without knob and scale.....	4.00
No. CV-1000 Unmounted .001 Mf.....	12.40
No. CV-1003 Unmounted, with vernier.....	17.10
No. CV-1010 Mounted in glass case without vernier .001 Mf.....	17.50
No. CV-1013 Mounted in glass case, with vernier.....	19.50
No. CV-1500 Unmounted .0015 Mf.....	13.95
No. CV-1503 Unmounted with vernier.....	13.75
No. CV-1510 Mounted in glass case without vernier .0015 Mf.....	18.95
No. CV-1513 Mounted in glass case with vernier.....	20.60
No. UCV-1000 On unit panel .001 Mf.....	13.60
No. UCV-1003 On unit panel with vernier.....	13.60
No. UCV-1500 On unit panel .0015 Mf.....	14.90
No. UCV-1503 On unit panel with vernier.....	20.10

Note: These are splendid condensers and are priced at exceptional values.

F. D. PITTS CO., BOSTON, MASS.

ANTENNA WIRE

No. F-1 7 strand No. 22 tinned copper, per foot.....	\$0.01 1/4
1000 ft. or over, per foot.....	0.01
No. F-2 No. 14 hard drawn copper, per lb. (80 ft. per lb.).....	.70
No. F-3 7 strand No. 20 Phosphor-bronze, per foot.....	.02 1/2
500 foot or over, per foot.....	.02

F. D. PITTS CO., BOSTON, MASS.

INSULATORS

No. 0-2 4" strain type.....	\$0.50
No. 0-3 10 1/2" strain type.....	1.00
No. 0-4 16" strain type.....	1.50

F. D. PITTS CO., BOSTON, MASS.

GROUND EQUIPMENT

No. G-100 100 Amp. 600 V. ground switch.....	\$4.50
No. G-2 Weather-proof No. 4 ground wire, per foot.....	.10
No. G-3 Heavy porcelain cleats with screws for wire, complete.....	.12

F. D. PITTS CO., BOSTON, MASS.

RHEOSTATS

No. R-2 Remler back mounting.....	\$1.75
No. R-3 Paragon back mounting.....	1.75
No. R-4 General Radio back mounting.....	2.50

F. D. PITTS CO., BOSTON, MASS.

JACKS

No. 1423-W Federal N. P. 2 circuit.....	\$1.00
No. 1422-W Federal N. P. closed circuit.....	.85
No. 1421-W Federal N. P. open circuit.....	.70
No. WE-1 Western Elec. 2 circuit.....	.95
No. WE-2 Western Elec. open circuit.....	.55

F. D. PITTS CO., BOSTON, MASS.

PLUGS

No. 1428-W Federal brass.....	\$2.00
No. 1428-W Federal silver-plated.....	2.50
No. WE-1 Western Elec. brass.....	1.20

F. D. PITTS CO., BOSTON, MASS.

VACUUM TUBES

Moorhead Electron Relay (detector).....	\$6.00
Moorhead Amplifier-Oscillator.....	7.00
Moorhead Transmitting.....	7.50
Audiotron Det. Amp. Osc.....	6.00

F. D. PITTS CO., BOSTON, MASS.

TUBE SOCKETS

No. GR-1 General Radio.....	\$1.75
No. R-300 DeForest.....	1.50
No. R-400 DeForest inverted type.....	2.75
No. MW-1 Marconi.....	1.50
No. 550 Murdock.....	1.00

F. D. PITTS CO., BOSTON, MASS.

REGENERATIVE RECEIVERS GREBE

No. CR-1 170-600 meters with tube control self-contained.....	\$30.00
No. CR-2 170-600 meters.....	51.00
No. CR-3 "Special" for Relay work, 170-600 meters.....	65.00
No. CR-4 170-600 meters with series condenser.....	65.00
No. CR-6 170-600 meters. Receiver, detector and two-step amplifier, self-contained. A complete set.....	200.00
No. CR-7 500-20000 meters. Long wave, with tube control. A complete receiver.....	210.00

(Give him that Grebe set. An incomparable Christmas gift.)

F. D. PITTS CO., BOSTON, MASS.

AUDION CONTROL PANELS

No. RORA Grebe with cabinet.....	\$12.50
No. RORH Grebe with Tick connections.....	17.00
No. P-401 DeForest in cabinet.....	14.25
No. P-500 DeForest in cabinet with 45 volts "B" battery.....	25.00

F. D. PITTS CO., BOSTON, MASS.

TELEPHONES (Pair)

No. 1 Type C Baldwins Navy Standard.....	\$16.50
No. 2 Type E Baldwins latest super-sensitive.....	18.50
Brandes Superior 2000 ohms.....	7.00
Brandes Trans-Atlantic 2800 ohms.....	12.00
Brandes Navy Type 3200 ohms.....	14.00
No. 55 Murdock 2000 ohms.....	4.50
No. 55 Murdock 3000 ohms.....	4.50
No. 52-W Century 3200 ohms Govt. standard.....	14.00
No. 53-W Century 2200 ohms Govt. standard.....	12.50

F. D. PITTS CO., BOSTON, MASS.

Important! Every article listed sent to any part of the United States postage or express prepaid. We want your business!

Series No. 8 Note:- Don't miss next month's ad. Watch for it!

F. D. PITTS CO., Inc.

12 Park Square

Dept. C

Boston, Mass., U.S.A.

Cable address "PITTSO" Boston



Every Electrical Man Wants These Books and we ship them **FREE** for your inspection

Flexible
Covers
—
Handy
Pocket-
Size
Volumes

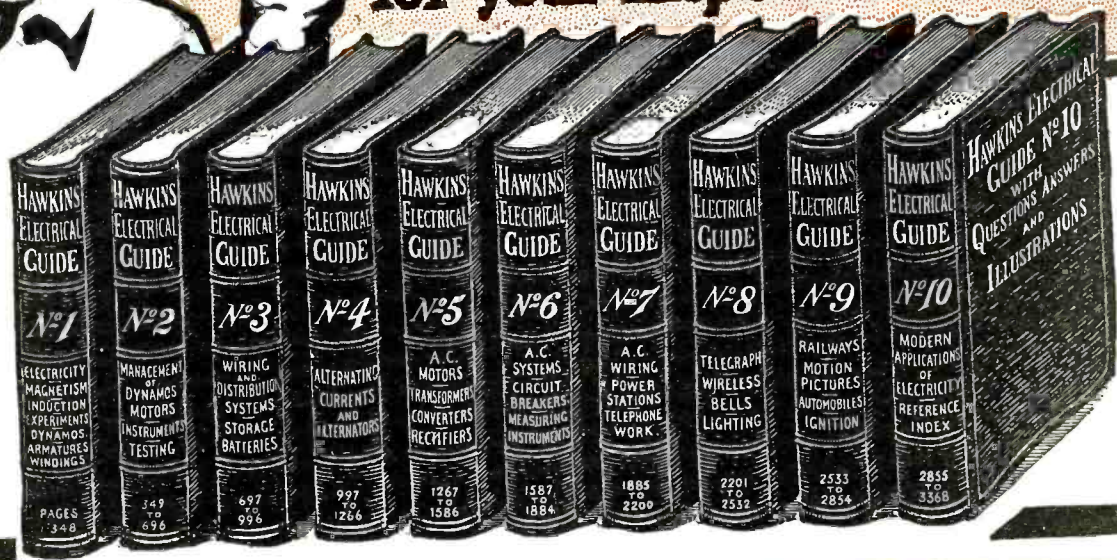

10
Volumes
3500
Pages
4700
Pictures
\$1 Per
Volume
\$1 Per
Month

Just what you need to know to succeed in **ELECTRICITY**

EVERY electrician, every engineer, every mechanic should know about these wonderfully helpful instructive books, which give in plain words a complete working knowledge of electrical engineering in all its phases.

You run into some new electrical problem almost every day. The information you need to help you in your every day work is in

HAWKINS ELECTRICAL GUIDES

These books place electricity at your finger ends. They cover every imaginable subject, principle, theory, problem, trouble, and way of doing things electrically. Every subject is indexed so that you can turn right to it. They are a study course and a reference guide in one, written in plain every day language—no wasted words and only what you need to know—chock full of up-to-the-minute electrical knowledge. The guides are a complete course in electrical engineering. They will help you in every detail of the day's electrical work. You can't ask an electrical question that Hawkins Guides can't answer.

Pocket-Size Flexible Covers

The books are small enough to slip into your coat pocket—handsomely bound in flexible black covers. You can carry each volume with you until you have mastered its contents. 3,500 pages of actual information and 4,700 illustrations. Once you see these books and put them into actual use you will never again want to be without them. Try it: at our expense.

SEND NO MONEY

It will cost you nothing to receive these books—to look them over—ask them all the questions you can think of—use them in your work—study them—pick up some information that will increase your earning ability. We will ship you the entire set of 10 volumes entirely FREE. This is a sign of our confidence in the guides. Pure gold does not object to being tested. Keep them for seven days and if you do not decide that you can't get along without them, return them to us and owe us nothing.

When you decide to keep them you only have to pay \$1.00 down and remit the balance of \$9.00 on the easy payment of \$1.00 a month till paid for. Use this coupon to get the books. It will pay you many times over.

THEO. AUDEL & CO.
72 Fifth Ave. New York, N. Y.

SEND NO MONEY - USE THE COUPON

READ THIS PARTIAL LIST OF CONTENTS

- No. 1** Contains 348 pages, 388 illustrations. Electrical signs and symbols—static and current electricity—primary cells—conductors and insulators—resistance and conductivity—magnetism—induction coils—dynamo principles—classes of dynamos—armatures—windings—commutation—brushes, etc.
- No. 2** Contains 348 pages, 394 illustrations. Motor principles—armature reaction—motor starting—calculations—brake horsepower—selection and installation of dynamo and motors—galvanometers—standard cells—current measurement—resistance measurement—voltmeters—wattmeters—watt hour meters—operation of dynamos—operation of motors, etc.
- No. 3** Contains 300 pages, 423 illustrations. Distribution systems—wires and wire calculations—inside, outside and underground wiring—sign flashers—lightning protection—rectifiers—storage battery systems, etc.
- No. 4** Contains 270 pages, 379 illustrations. Alternating current—principles—alternating current diagrams—the power factor—alternator principles—alternator construction—windings, etc.
- No. 5** Contains 320 pages, 614 illustrations. A.C. Motor—synchronous and induction motor principles—A.C. commutator motors—induction motors—transformers—losses, construction, connections, tests—converters—rectifiers, etc.
- No. 6** Contains 298 pages, 472 illustrations. Alternating current systems—switching devices—circuit breakers—relays—lighting protector apparatus—regulating devices—synchronous condensers—indicating devices—meters—power factor indicators—wave form measurement—switch boards, etc.
- No. 7** Contains 318 pages, 376 illustrations. Alternating current, wiring power stations—turbines; management, selection, location, erection, testing, running, care and repair—telephones, etc.
- No. 8** Contains 332 pages, 436 illustrations. Telegraph—simultaneous telegraphy and telephony—wireless—electric bells—electric lighting—photometry, etc.
- No. 9** Contains 322 pages, 627 illustrations. Electric railways—electric locomotives—car lighting—trolley car operation—miscellaneous applications—motion pictures—gas engine ignition—automobile self-starters and lighting systems, electric vehicles, etc.
- No. 10** Elevators—cranes—pumps—air compressors—electric heating—electric welding—soldering and brazing—industrial electrolysis—electro plating—electro-therapeutic—X-rays, etc.

Also a complete 126-page ready reference index of the complete library. This index has been planned to render easily accessible all the vast information contained in the 10 electrical guides. There are over 13,500 cross references. You find what you want to know instantly.

THEO. AUDEL & CO.
72 Fifth Ave.
New York, N. Y.

Please submit me for examination Hawkins Electrical Guides (price \$1 each). Ship at once, prepaid, the 10 numbers. If satisfactory I agree to send you \$1 within seven days and to further mail you \$1 each month until paid.

Signature.....
Occupation.....
Employed by.....
Residence.....
Reference..... R.N. Nov.

What Electrical Men Say Helped Him Make Good

"It is only right for me to recommend highly the Hawkins Guides, for they have been of the greatest assistance to me in placing me in my present position as Superintendent of Construction Department of one of Ohio's largest Electrical Companies. I would like to see every man have a set of Hawkins Guides."
Geo. Knecht, Columbus, Ohio.

In the Naval Electrical Dept.
"The Hawkins Guides are a great help to me in the Naval Electrical Department, which they cover very thoroughly."
C. J. Cornell,
U. S. Receiving Ship, Brooklyn, N. Y.

Superintendent
"I am now superintendent of the Dunnville Hydro-Electric Systems, and Hawkins Guides were a great help to me in holding down a responsible position."
W. E. Swartz, Dunnville, Ontario.

Wireless Operators
"I have worked wireless for ten years—but I wish I had these books years ago, as they have saved me a great deal of trouble."
E. Marshall,
Steamer M & E No. 2,
Walkerville, Ont.

LEARN WIRELES AT HOME BY MAIL

Calls coming in steadily, for National Radio Institute Graduates. Big Concerns in Need of Operators.

Many attractive positions are now open in Commercial Land Radio Service, Merchant Marine, Radio Supply Factories, Lake and Ocean Steamship Lines, Telegraph Companies, and U. S. Shipping Board. We are continually receiving requests for more National Radio Institute Graduates than we can furnish.

Salaries Up to \$3,500 a Year

Pay As You Learn

Exceptional opportunity for ambitious men for promotion to the higher branches of Radio. You can learn Wireless the National Radio Institute way, quickly and easily, by mail right in your own home in your spare time. No previous experience or training is necessary. With our help you can quickly qualify for a First Grade Government License, and a good position. Our graduates are qualified as Senior Operators and start with a salary of \$125 a month besides Room, Board, and Laundry, which when totalled and added to salary, means more than \$200 a month. One of our recent graduates is getting \$6000 a year.

Our plans of payment place a wireless education within the reach of anyone who desires to learn. A small payment down, and the small payments made during the course, make it possible for you to earn the cost of your tuition while actually learning to be a wireless operator.

Instruments Furnished Free

In addition to all necessary text books and other equipment with which we supply you, we furnish FREE to every student, a Natrometer, which consists of an automatic transmitter and receiver. You receive the instrument after your enrollment; it becomes your personal property upon completion of our course.

The Natrometer automatically sends you messages in International Code, just as though they were coming to you through the air from a station a thousand miles away! The instrument is operated entirely without the use of aerials.

FREE. In addition to our complete course in Radio Telegraphy, every student is given our complete course in modern Radio Telephony. These combined courses enable our students to fill positions requiring a knowledge of both Radio Telegraphy and Telephony.

Send the following coupon today for our FREE BOOK containing all particulars.

NATIONAL RADIO INSTITUTE
America's First and Foremost
Established 1914—Dept. 362,
14th and U Streets, N. W.,
Washington, D. C.

MAIL THIS COUPON TODAY

NATIONAL RADIO INSTITUTE,
Dept. 362, 14th and U Sts., N. W.,
Washington, D. C.

Send me your FREE book "Wireless The Opportunity Today." Tell me about your Home Study Course Wireless Telegraphy and Telephony—the free practical graduate course—and your Special Instrument offer.

Name

Address

City State



MERCHANT MARINE



LAND COMMERCIAL RADIO



TRAIN DISPATCHING

